

# SYSTEMS FOR BATHROOM AND SHOWER

Programme · Prices in Euro excl. VAT · effective January 1, 2025



# Welcome to LUX ELEMENTS



The family-owned company LUX ELEMENTS is an experienced specialist in handling polystyrene hard foam and its further processing into secure substrates for bathrooms and wellness areas.

The product range is based on the ground-breaking invention of company founder Herbert Lux, patented in 1981: 'The Original' – a support element with a core of hard foam and double-sided mortar coating in which a stabilising glass fibre fabric is embedded.

Starting from the construction panel in different thicknesses, the range has been constantly developed and expanded. Today, LUX ELEMENTS offers complete systems for **bathroom and shower, private spa and wellness.**



# LUX ELEMENTS® – The original

On account of its outstanding physical properties in combination with very good workability, this moisture-resistant and modern building material creates free space for planners, designers, tradesmen and industry – whether in the form of panels, blanks or ready-made products.

Hard foam support elements from LUX ELEMENTS are characterised by these advantages:

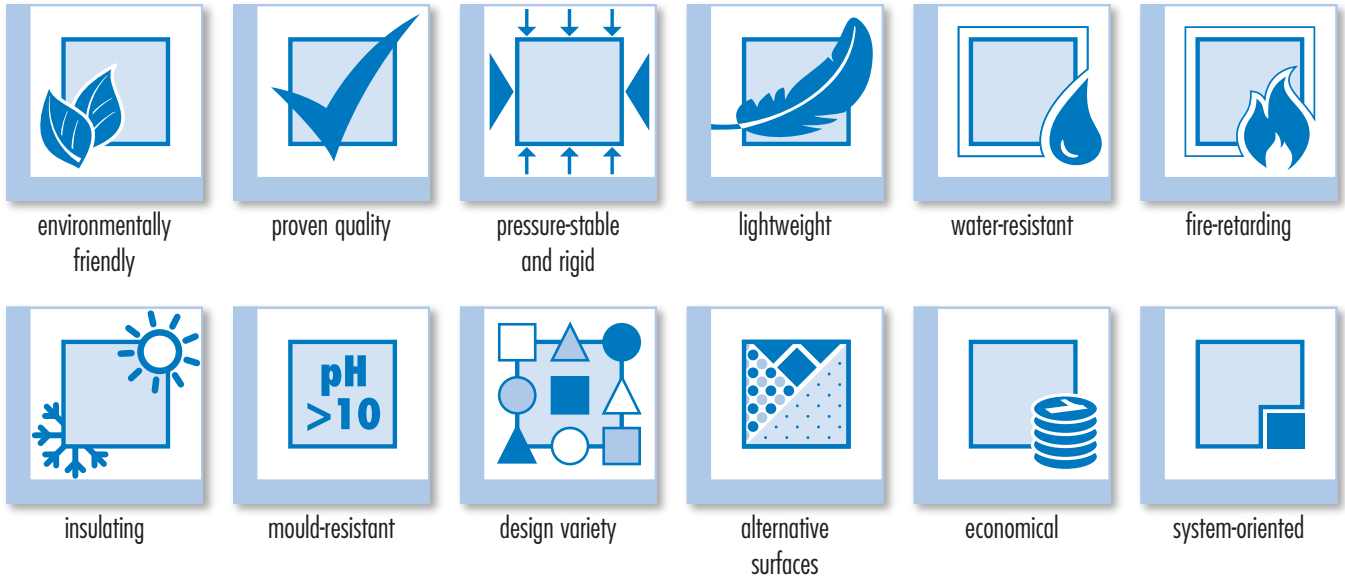

Detailed information on the material properties can be found in the brochure **'Sustainability – The Original can do'**  
(Download from [www.luxelements.com](http://www.luxelements.com) under *Downloads/Information brochure*)

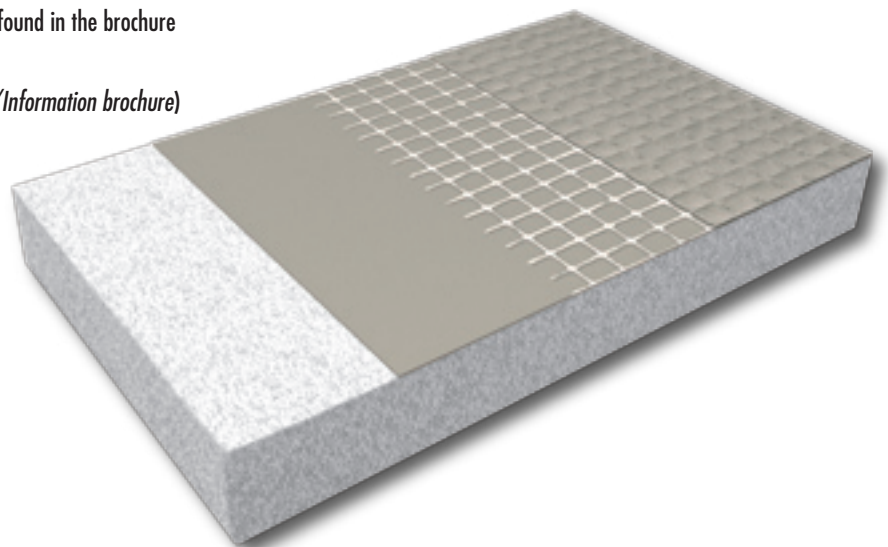

# LUX ELEMENTS – Products

## ■ Standard products and mounting material

The LUX ELEMENTS product portfolio includes a wide range of prefabricated shaped parts and building kits made of hard foam support material as standard products with fixed dimensions or in graduated sizes. This range is complemented by matching technical system products.

Furthermore, LUX ELEMENTS offers an extensive range of assembly materials for the safe processing of hard foam support elements, including adhesives, sealing tapes and sealing fillers as well as reinforcement fabric and mounting aids.

Together, all the products form **systems** for **bathroom construction** and **design**, including flush with the floor **shower bases** as well as the design of **private and public wellness areas**.

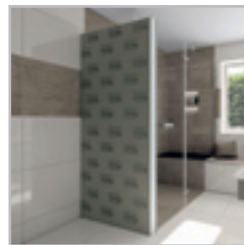

## ■ LUX ELEMENTS®-... PLUS – Individually made to measure

Unable to find the desired versions of standard products or looking for other dimensions or a different shape? LUX ELEMENTS is able to produce bespoke individual products. These bespoke productions bear the suffix 'PLUS'.

Just ask for the article you want. After successfully checking the technical feasibility you will receive an individual quotation.



### Examples

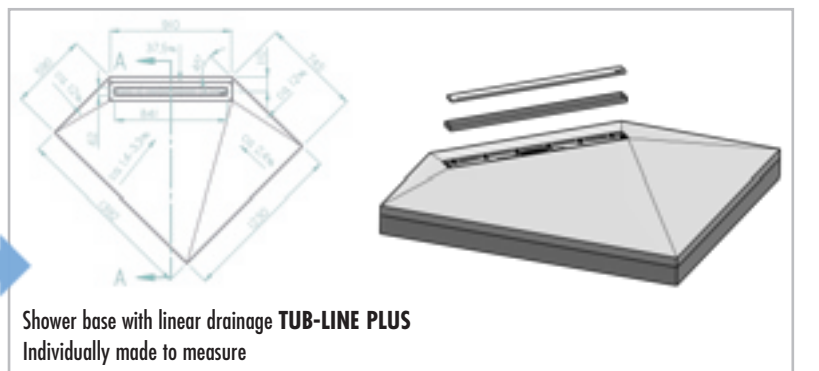
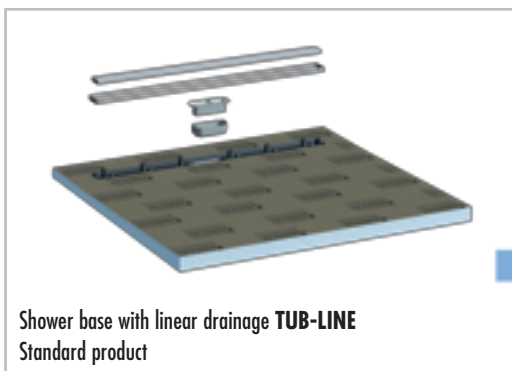
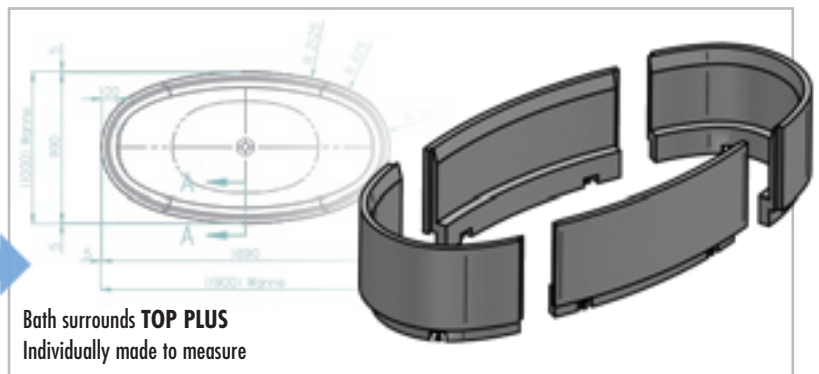
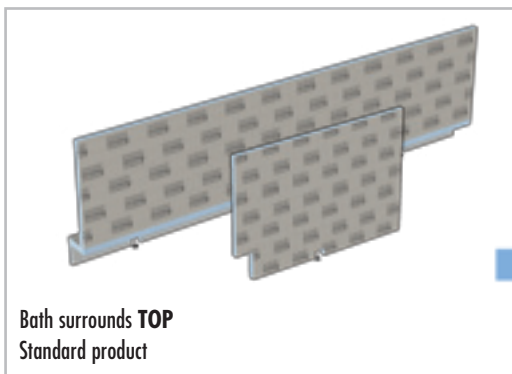
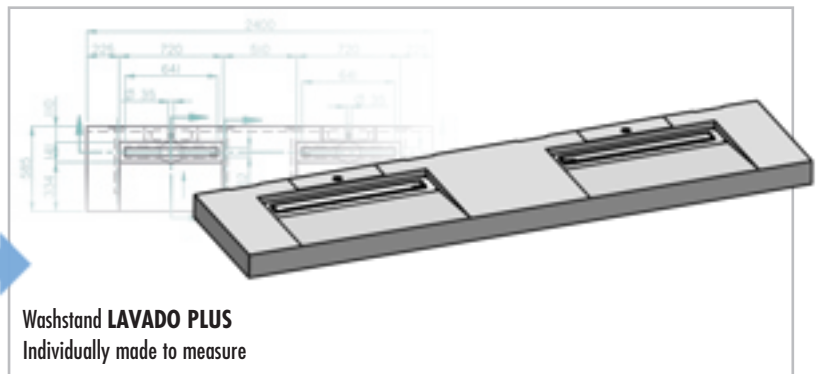
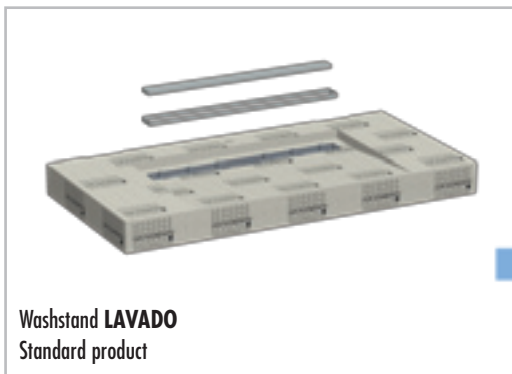

# LUX ELEMENTS – Online

## ■ Website – Product information and download centre



Detailed information on all products and on the company and link to the online calculator (see page 7).

A clearly arranged download area contains data sheets, assembly instructions, test reports and all brochures in PDF format.

[www.luxelements.com](http://www.luxelements.com)



## ■ YouTube – Product and assembly videos

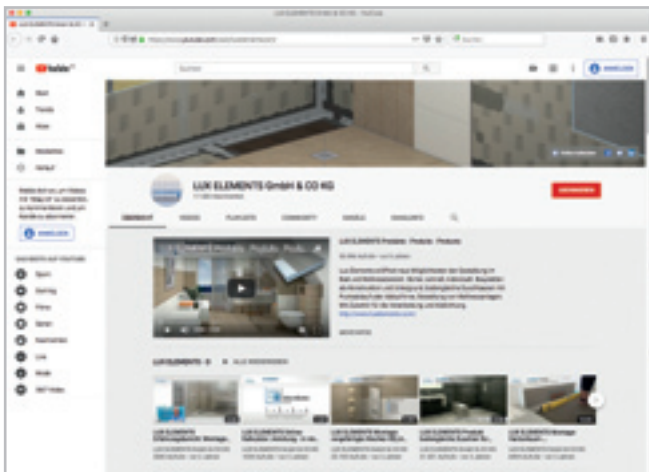

Illustrative information on many products, arranged into playlists. An extensive range of assembly videos shows you step by step how fast and simple the installation of the LUX ELEMENTS® hard foam support elements is:

[www.youtube.com/user/luxelementscom](http://www.youtube.com/user/luxelementscom)



## ■ Social Media – Current news and pictures

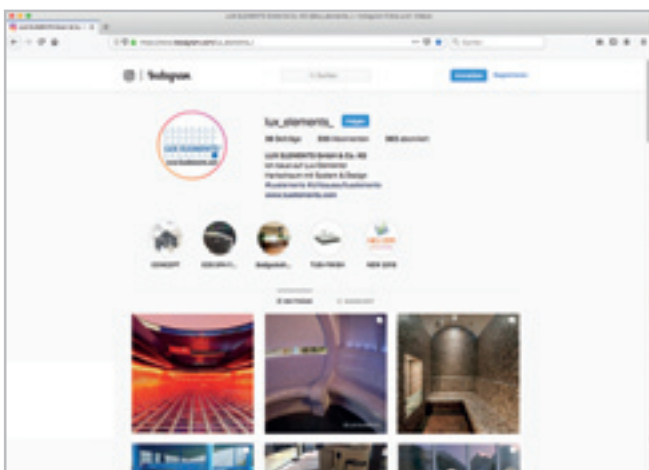

The LUX ELEMENTS social media channels provide information on trade fairs, customer events, products, anniversaries and much more. Subscribe to our company pages – you're in for a surprise!

Facebook



Instagram



LinkedIn



## ■ Online calculator – Determining your own material requirements



... was never as simple and quick as this.

Get a complete bill of materials free of charge and without obligation – in a few steps – with the help of the online calculator.

Simply click on the icon at [www.luxelements.com](http://www.luxelements.com) ...

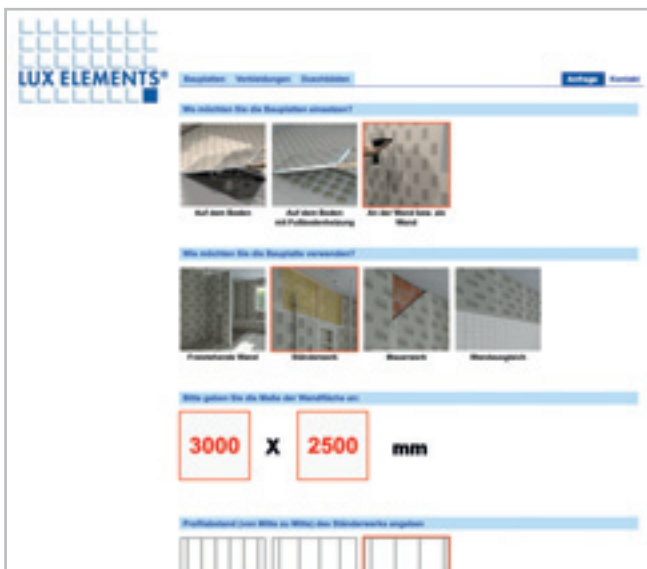

- Select the category ...
- Answer the questions ...
- Step by step to the result ...



- Generate the list ...
- Done!

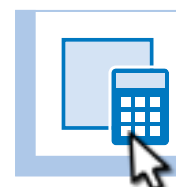

# LUX ELEMENTS – Systems for bathroom and shower



**Bathroom  
construction**



**Bathroom  
design**



**Showers**



**Construction panels – LUX ELEMENTS®-ELEMENT**

**Construction panel for underfloor heating – LUX ELEMENTS®-FLOOR**

**Fastening sets and dowels – LUX ELEMENTS®-FIX**

**Adhesives – LUX ELEMENTS®-COL**

**Sealing tapes and sealing filler – LUX ELEMENTS®-DRY**

**Reinforcement fabric – LUX ELEMENTS®-ARM**

**Mounting aids – LUX ELEMENTS®-MONT**

## **Systems for bathroom construction**

from page 10

**Installation cladding – LUX ELEMENTS®-TEC**

**Bath surrounds – LUX ELEMENTS®-TOP**

**Washstands – LUX ELEMENTS®-LAVADO**

**Bath tubs – LUX ELEMENTS®-RELAX-BW**

**Niches – LUX ELEMENTS®-RELAX-NI**

**Benches – LUX ELEMENTS®-RELAX-BA**

**Shower partition walls – LUX ELEMENTS®-RELAX-TW**

## **Systems for bathroom design**

from page 30

**Point drainage – LUX ELEMENTS®-TUB-...**

**Linear drainage– LUX ELEMENTS®-TUB-LINE ...**

- ... on unfinished floor in screed
- ... on unfinished floor with integrated drainage technology
- ... on unfinished floor with separate drainage technology
- ... in wooden sub-constructions
- Drainage technology and accessories

## **Systems for showers**

from page 58

# LUX ELEMENTS – Systems for bathroom and shower

## Bathroom construction

Here you will find all LUX ELEMENTS products for the construction of a bathroom. This includes the manufacture of substrates for tiles, panels and plaster on the walls and floor as well as cladding, sealing, construction and insulation. The bathroom construction is the basis for the bathroom design (from page 30).



# Bathroom construction – Content



## Construction panels

Universal construction panel – ELEMENT-EL .....	12
Easy to process on the building site – ELEMENT Baby Panel .....	14
Saves time with large areas – ELEMENT Maxi Panel .....	14
Pre-slit construction panel – ELEMENT-SL/SQ .....	16
Multi-functional construction panel – ELEMENT-VK .....	16

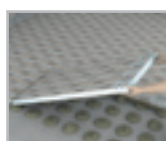

## Construction panel for underfloor heating

Construction panel for underfloor heating – FLOOR-WH F .....	18
--	----



## Fastening sets and dowels

Plastic hammer fix plug – FIX-KSD .....	20
Hammer fix plugs – FIX-FID .....	20
Special screw plug – FIX-SD .....	20
Screw and washer fastening set – FIX-HS/-SB .....	20
Hard plastic insert – FIX PRO-MAK .....	20



## Adhesives

Primer – COL-HSV .....	22
Fixing adhesive – COL-AK .....	22
Mounting adhesive – COL-MK .....	22



## Sealing tapes and sealing filler

Sealing tape – DRY-DB .....	24
Sealing film – DRY-DF .....	24
Expansion zone sleeve – DRY-DBDZM .....	24
Sealing tape for ELEMENT-VK – DRY-DBV .....	24
Cut protection tape – DRY-SB .....	24
Sealing filler – DRY-ASK .....	24



## Reinforcement fabric

Reinforcement fabric – ARM .....	26
----------------------------------	----

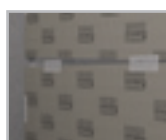

## Mounting aids

Mounting aids – MONT-UNI and -H .....	28
Adjusting bath tub claddings – MONT-TOPFIX .....	28
Insertion of inspection openings – MONT-TOPREV .....	28



## Universal construction panel **ELEMENT-EL**

- Moisture-insensitive substrate
- For watertight walls in your private shower
- Reliable on wall and floor
- Creative in design
- Water-resistant and mould-resistant

### Application areas

Thin thicknesses up to 30 mm:

- 4 and 6 mm: e.g. wall levelling
- 10, 12 and 20 mm: stud frame planking
- from 30 mm: installation on dots

Thicker thicknesses from 30 to 100 mm:

- cladding
- construction
- insulating

### Mixed pallets ELEMENT-EL MIX

- Prefabricated mixed pallets for reduced time and effort in ordering and handling
- Fast availability due to defined standard articles
- Optimised for standard applications, e.g. for wall levelling



■ **PRODUCT SPECIFICATIONS – LUX ELEMENTS®-ELEMENT** Packaging specifications see p. 138 · Online calculator see p. 7 · \* standard-compliant according to DIN 18534

ARTICLE-NUMBER	ARTICLE-NAME / ARTICLE-DESCRIPTION	NOMINAL FORMATS/DIMENSIONS LENGTH x WIDTH x THICKNESS	UNIT	PRICE / UNIT €
----------------	------------------------------------	--	------	----------------

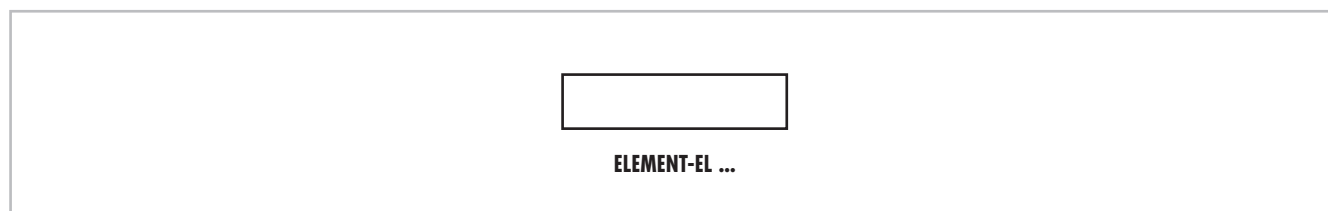

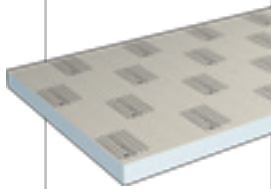
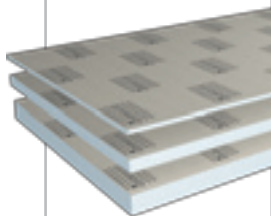
	<b>LELEE1119</b>	<b>ELEMENT-EL 10*</b> , hard foam support element	2500 x 600 x 10 mm	m <sup>2</sup>	36,11
	<b>LELEE1131</b>	<b>ELEMENT-EL 12*</b> , hard foam support element	2500 x 600 x 12 mm	m <sup>2</sup>	37,24
	<b>LELEE1120</b>	<b>ELEMENT-EL 20*</b> , hard foam support element	2500 x 600 x 20 mm	m <sup>2</sup>	40,40
	<b>LELEE1121</b>	<b>ELEMENT-EL 30*</b> , hard foam support element	2500 x 600 x 30 mm	m <sup>2</sup>	43,91
	<b>LELEE1123</b>	<b>ELEMENT-EL 40*</b> , hard foam support element	2500 x 600 x 40 mm	m <sup>2</sup>	48,51
	<b>LELEE1122</b>	<b>ELEMENT-EL 50*</b> , hard foam support element	2500 x 600 x 50 mm	m <sup>2</sup>	53,15
	<b>LELEE1133</b>	<b>ELEMENT-EL 80*</b> , hard foam support element	2500 x 600 x 80 mm	m <sup>2</sup>	68,91
	<b>LELEE1137</b>	<b>ELEMENT-EL 100*</b> , hard foam support element	2500 x 600 x 100 mm	m <sup>2</sup>	78,95
	<b>LELEEMIX2000</b>	<b>ELEMENT-EL MIX 1*</b> , mixed pallet with hard foam support elements, consisting of: 33 m <sup>2</sup> /22 pieces EL 10, 33 m <sup>2</sup> /22 pieces EL 30, 9 m <sup>2</sup> /6 pieces EL 40		set	3.077,03
	<b>LELEEMIX2001</b>	<b>ELEMENT-EL MIX 2*</b> , mixed pallet with hard foam support elements, consisting of: 30 m <sup>2</sup> /20 pieces EL 10, 30 m <sup>2</sup> /20 pieces EL 30, 15 m <sup>2</sup> /10 pieces EL 50		set	3.197,62
	<b>LELEEMIX2002</b>	<b>ELEMENT-EL MIX 3*</b> , mixed pallet with hard foam support elements, consisting of: 30 m <sup>2</sup> /20 pieces EL 10, 30 m <sup>2</sup> /20 pieces EL 20, 15 m <sup>2</sup> /10 pieces L 30		set	2.953,68
	<b>LELEEMIX2003</b>	<b>ELEMENT-EL MIX 4*</b> , mixed pallet with hard foam support elements, consisting of: 45 m <sup>2</sup> /30 pieces EL 20, 24 m <sup>2</sup> /16 pieces EL 30, 6 m <sup>2</sup> /4 pieces EL 50		set	3.190,43



LUX ELEMENTS manufactures individual customised and special products for ELEMENT.

These include dimensions, thicknesses, shapes etc. that deviate from the standard programme. For more information see page 5.



Visit [www.luxelements.com](http://www.luxelements.com) for further information on ELEMENT.

Data sheets, assembly instructions, test certificates and additional brochures under 'Downloads', videos under 'Practice' and on YouTube.



## Easy to process on the building site

### **ELEMENT Baby Panel**

- 'One-man panel' in a half-length (1250 x 600 mm)
- Easy transport, even in confined spaces
- Fits into smaller vans and other vehicles without being cut to size
- More comfortable installation in small rooms or in attics due to its handy size
- Well suited for floor applications
- Also available as a pre-assembled **mixed pallet** (see page 12)

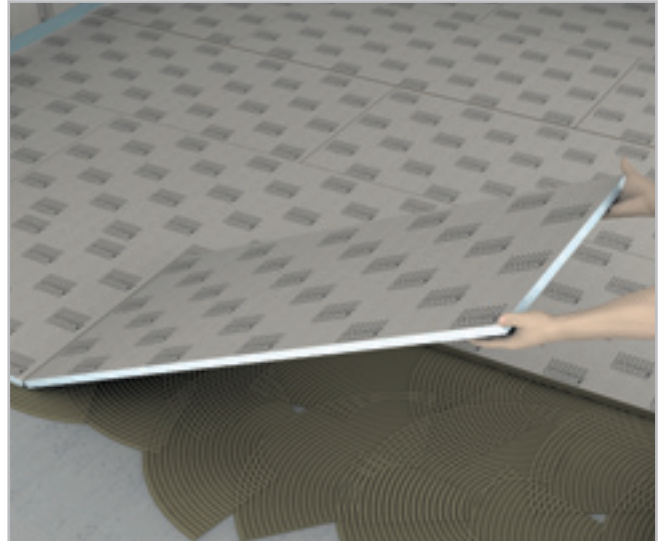

## Saves time with large areas

### **ELEMENT Maxi Panel**

- Enlarged width (2500 x 900 mm)
- Fast installation on large areas
- Fewer element joints in the shower area
- Fewer panel joints that need to be reinforced and filled
- Also in a thicker version (50, 80, 100 mm) e.g. for quick construction of partition walls
- Also available as a pre-assembled **mixed pallet** (see page 12)



■ **PRODUCT SPECIFICATIONS – LUX ELEMENTS®-ELEMENT** Packaging specifications see p. 138 · Online calculator see p. 7 · \* standard-compliant according to DIN 18534

ARTICLE-NUMBER	ARTICLE-NAME / ARTICLE-DESCRIPTION	NOMINAL FORMATS/DIMENSIONS LENGTH x WIDTH x THICKNESS	UNIT	PRICE / UNIT €
----------------	------------------------------------	--	------	----------------

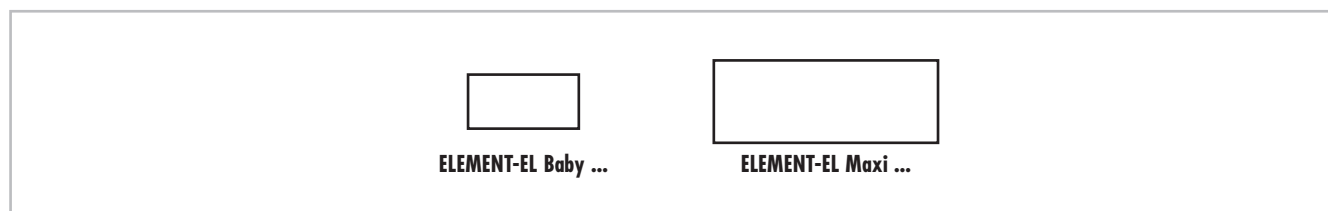

	<b>LELEE1116</b>	<b>ELEMENT-EL Baby 4*</b> , hard foam support element	1250 x 600 x 4 mm	m <sup>2</sup>	35,71
	<b>LELEE1117</b>	<b>ELEMENT-EL Baby 6*</b> , hard foam support element	1250 x 600 x 6 mm	m <sup>2</sup>	34,33
	<b>LELEE1118</b>	<b>ELEMENT-EL Baby 10*</b> , hard foam support element	1250 x 600 x 10 mm	m <sup>2</sup>	36,12
	<b>LELEE1135</b>	<b>ELEMENT-EL Baby 12*</b> , hard foam support element	1250 x 600 x 12 mm	m <sup>2</sup>	37,23
	<b>LELEE1141</b>	<b>ELEMENT-EL Baby 20*</b> , hard foam support element	1250 x 600 x 20 mm	m <sup>2</sup>	40,40
	<b>LELEE1142</b>	<b>ELEMENT-EL Baby 30*</b> , hard foam support element	1250 x 600 x 30 mm	m <sup>2</sup>	43,91
	<b>LELEE1143</b>	<b>ELEMENT-EL Baby 40*</b> , hard foam support element	1250 x 600 x 40 mm	m <sup>2</sup>	48,51
	<b>LELEE1144</b>	<b>ELEMENT-EL Baby 50*</b> , hard foam support element	1250 x 600 x 50 mm	m <sup>2</sup>	53,15
	<b>LELEE1145</b>	<b>ELEMENT-EL Baby 80*</b> , hard foam support element	1250 x 600 x 80 mm	m <sup>2</sup>	68,90
	<b>LELEE1146</b>	<b>ELEMENT-EL Baby 100*</b> , hard foam support element	1250 x 600 x 100 mm	m <sup>2</sup>	78,95
	<b>LELEEMIX1000</b>	<b>ELEMENT-EL BABY MIX 1*</b> , mixed pallet with hard foam support elements, consisting of: 30 m <sup>2</sup> /40 pieces EL Baby 4, 30 m <sup>2</sup> /40 pieces EL Baby 6, 15 m <sup>2</sup> /20 pieces EL Baby 10		set	2.642,40
	<b>LELEE1210</b>	<b>ELEMENT-EL Maxi 12*</b> , hard foam support element	2500 x 900 x 12 mm	m <sup>2</sup>	39,17
	<b>LELEE1211</b>	<b>ELEMENT-EL Maxi 20*</b> , hard foam support element	2500 x 900 x 20 mm	m <sup>2</sup>	42,74
	<b>LELEE1212</b>	<b>ELEMENT-EL Maxi 50*</b> , hard foam support element	2500 x 900 x 50 mm	m <sup>2</sup>	56,00
	<b>LELEE1213</b>	<b>ELEMENT-EL Maxi 80*</b> , hard foam support element	2500 x 900 x 80 mm	m <sup>2</sup>	70,74
	<b>LELEE1214</b>	<b>ELEMENT-EL Maxi 100*</b> , hard foam support element	2500 x 900 x 100 mm	m <sup>2</sup>	81,50
	<b>LELEEMIX3000</b>	<b>ELEMENT-EL MAXI MIX 1*</b> , mixed pallet with hard foam support elements, consisting of: 45 m <sup>2</sup> /20 pieces EL Maxi 12, 45 m <sup>2</sup> /20 pieces EL Maxi 20		set	3.685,77



LUX ELEMENTS manufactures individual customised and special products for ELEMENT.

These include dimensions, thicknesses, shapes etc. that deviate from the standard programme. For more information see page 5.



Visit [www.luxelements.com](http://www.luxelements.com) for further information on ELEMENT.

Data sheets, assembly instructions, test certificates and additional brochures under 'Downloads', videos under 'Practice' and on YouTube.

**LUX ELEMENTS®-ELEMENT-SL/SQ**  
Standard-compliant substrate without further sealing  
for private shower areas according to DIN 18534



**LUX ELEMENTS®-ELEMENT-VK**  
Standard-compliant sealing for highly stressed  
areas according to DIN 18534, Part 6



### Pre-slit construction panel **ELEMENT-SL/SQ**

- Factory pre-slit hard foam support elements, vertically slit (SL) or horizontally slit (SQ)
- Flexible, fast and clean shaping of round forms, e.g. rounded partition walls



### Multi-functional construction panel **ELEMENT-VK**

- Factory-sealed construction panel (panel-type sealing element AIV-P) with vapour barrier properties
- Unites the benefits of the ELEMENT-EL universal construction panel with those of a seal
- Also available as **Baby panel** ('one-man panel') in a half-length of 1250 mm (see page 14)
- Matching mounting material e.g. sealing tapes, inner and outer corners, see page 24



### Application areas

In wet rooms where sealing or a vapour barrier is required:

- on the wall
- to laths
- to framework

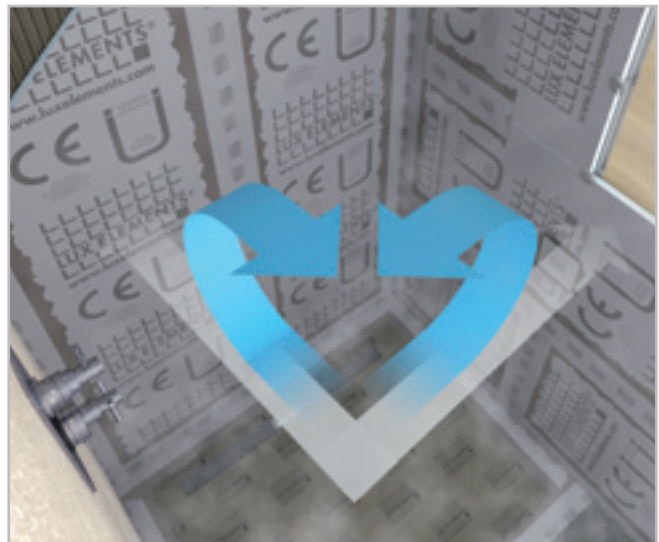



ETA-13/0238  
LUX ELEMENTS®  
WATERTIGHT SOLUTION  
COMPONENT 3.1/8  
www.luxelements.com  
0799-CPR-130 - Nr LEWS2013

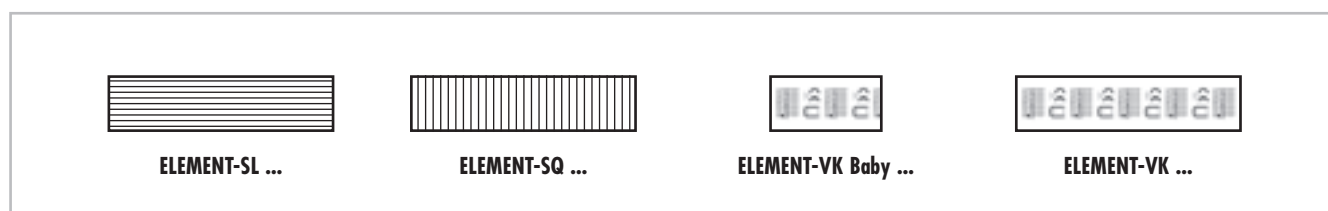

■ **PRODUCT SPECIFICATIONS – LUX ELEMENTS®-ELEMENT** Packaging specifications see p. 126 · Online calculator see p. 7 · \* standard-compliant according to DIN 18534

ARTICLE-NUMBER	ARTICLE-NAME / ARTICLE-DESCRIPTION	NOMINAL FORMATS/DIMENSIONS LENGTH x WIDTH x THICKNESS	UNIT	PRICE / UNIT €
----------------	------------------------------------	--	------	----------------

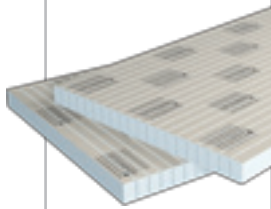

	<b>LELEE2001</b>	<b>ELEMENT-SL 30*</b> , hard foam support element, vertically slit	2500 x 600 x 30 mm	m <sup>2</sup>	86,40
	<b>LELEE2003</b>	<b>ELEMENT-SL 50*</b> , hard foam support element, vertically slit	2500 x 600 x 50 mm	m <sup>2</sup>	99,49
	<b>LELEE2002</b>	<b>ELEMENT-SQ 30*</b> , hard foam support element, horizontally slit	2500 x 600 x 30 mm	m <sup>2</sup>	103,86
	<b>LELEE2004</b>	<b>ELEMENT-SQ 50*</b> , hard foam support element, horizontally slit	2500 x 600 x 50 mm	m <sup>2</sup>	117,08
	<b>LELEE3009</b>	<b>ELEMENT-VK Baby 6*</b> , hard foam support element, fleece backed on one side	1250 x 600 x 6 mm	m <sup>2</sup>	42,26
	<b>LELEE3010</b>	<b>ELEMENT-VK Baby 12*</b> , hard foam support element, fleece backed on one side	1250 x 600 x 12 mm	m <sup>2</sup>	45,03
	<b>LELEE3011</b>	<b>ELEMENT-VK Baby 20*</b> , hard foam support element, fleece backed on one side	1250 x 600 x 20 mm	m <sup>2</sup>	48,03
	<b>LELEE3012</b>	<b>ELEMENT-VK Baby 30*</b> , hard foam support element, fleece backed on one side	1250 x 600 x 30 mm	m <sup>2</sup>	51,34
	<b>LELEE3013</b>	<b>ELEMENT-VK Baby 50*</b> , hard foam support element, fleece backed on one side	1250 x 600 x 50 mm	m <sup>2</sup>	60,02
	<b>LELEE3001</b>	<b>ELEMENT-VK 12*</b> , hard foam support element, fleece backed on one side	2500 x 600 x 12 mm	m <sup>2</sup>	45,03
	<b>LELEE3002</b>	<b>ELEMENT-VK 20*</b> , hard foam support element, fleece backed on one side	2500 x 600 x 20 mm	m <sup>2</sup>	48,03
	<b>LELEE3003</b>	<b>ELEMENT-VK 30*</b> , hard foam support element, fleece backed on one side	2500 x 600 x 30 mm	m <sup>2</sup>	51,34
	<b>LELEE3005</b>	<b>ELEMENT-VK 50*</b> , hard foam support element, fleece backed on one side	2500 x 600 x 50 mm	m <sup>2</sup>	60,02



LUX ELEMENTS manufactures individual customised and special products for ELEMENT.

These include dimensions, thicknesses, shapes etc. that deviate from the standard programme. For more information see page 5.



Visit [www.luxelements.com](http://www.luxelements.com) for further information on ELEMENT.

Data sheets, assembly instructions, test certificates and additional brochures under 'Downloads', videos under 'Practice' and on YouTube.

## Construction panel for underfloor heating FLOOR-WH F

- Hard foam support element with milling for installing underfloor heating pipes under ceramic surfaces
- In two sizes and two version
- Installation and insulating element in one
- Low installation heights – ideal for renovations
- Quick and easy installation
- No screed necessary
- Short drying times during renovation
- Rapid heating of the room due to direct heat dissipation into the ceramic top covering
- Suitable for water heating with pipe diameter 16 mm
- Simple to process for adaptation to room situation

**Please note:** LUX ELEMENTS®-FLOOR-WH F is suitable for use on either wooden floors or mineral substrates such as concrete or screed. Using FLOOR-WH F 30 the fixing adhesive must always be applied over the full surface, FLOOR-WH F 50 can also be placed on dots (dots spacing  $\leq 200$  mm). For wooden floors, full coverage adhesion is always required.

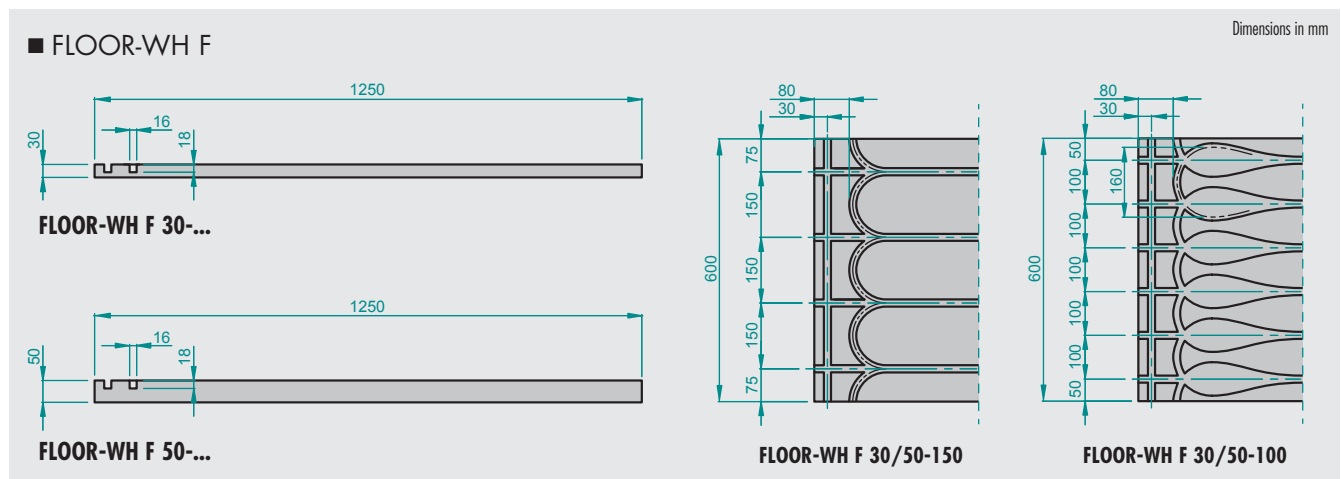
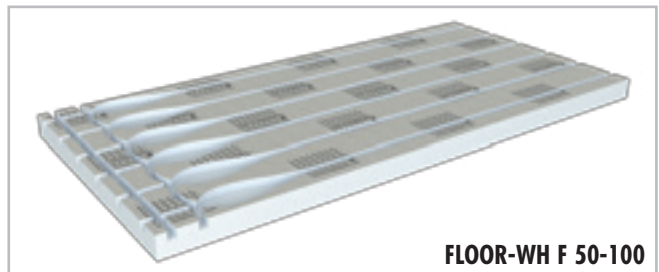
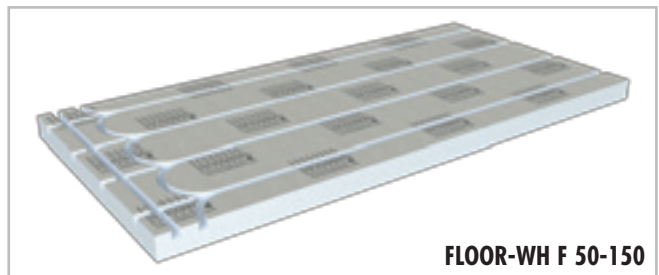
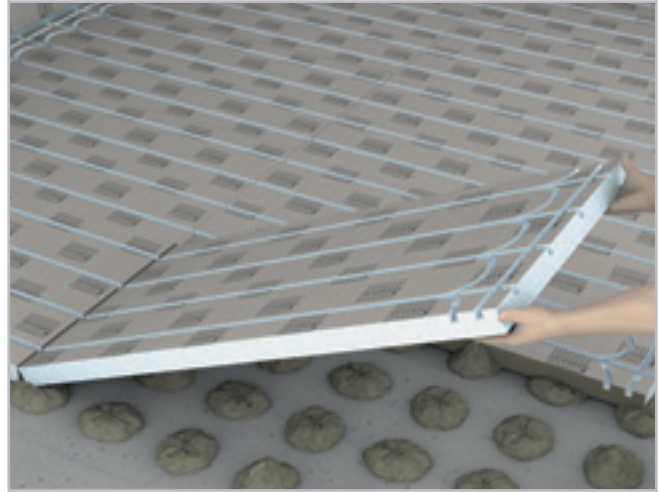

## CONSTRUCTION PANEL FOR UNDERFLOOR HEATING – BATHROOM CONSTRUCTION

### ■ PRODUCT SPECIFICATIONS – LUX ELEMENTS®-FLOOR

Packaging specifications see p. 139

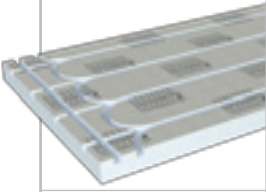
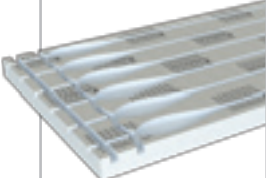
	ARTICLE-NUMBER	ARTICLE-NAME / ARTICLE-DESCRIPTION	NOMINAL FORMATS/DIMENSIONS LENGTH x WIDTH x THICKNESS	UNIT	PRICE / UNIT €
	<b>LFLOOR1000</b>	<b>FLOOR-WH F 30-150</b> , hard foam support element, with milled holes for the installation of underfloor heating pipes, laying distance 150 mm, pipe diameter 16 mm	1250 x 600 x 30 mm	m <sup>2</sup>	65,79
	<b>LFLOOR1001</b>	<b>FLOOR-WH F 50-150</b> , hard foam support element, with milled holes for the installation of underfloor heating pipes, laying distance 150 mm, pipe diameter 16 mm	1250 x 600 x 50 mm	m <sup>2</sup>	71,30
	<b>LFLOOR1002</b>	<b>FLOOR-WH F 30-100</b> , hard foam support element, with milled holes for the installation of underfloor heating pipes, laying distance 100 mm, pipe diameter 16 mm	1250 x 600 x 30 mm	m <sup>2</sup>	65,79
	<b>LFLOOR1003</b>	<b>FLOOR-WH F 50-100</b> , hard foam support element, with milled holes for the installation of underfloor heating pipes, laying distance 100 mm, pipe diameter 16 mm	1250 x 600 x 50 mm	m <sup>2</sup>	71,30



LUX ELEMENTS manufactures individual customised and special products for FLOOR.

These include dimensions, thicknesses, shapes etc. that deviate from the standard programme. For more information see page 5.



Visit [www.luxelements.com](http://www.luxelements.com) for further information on FLOOR.

Data sheets, assembly instructions, test certificates and additional brochures under 'Downloads', videos under 'Practice' and on YouTube.

### Fastening sets and dowels

#### FIX

Fastening sets/aids and dowels in a system for LUX-ELEMENTS® hard foam support elements:

##### Plastic hammer fix plug – FIX-KSD

- For fixing LUX ELEMENTS® hard foam support elements to an interior wall
- Drill with 8 mm drill
- Anchoring depth: 30–50 mm

##### Hammer fix plugs – FIX-FID

- Drill with 8 mm drill
- Anchoring depth: min. 50 mm
- Note: guaranteed fastening only with firm substrate for the 50 mm-long spreading part

##### Special screw plug – FIX-SD

- For connecting LUX ELEMENTS® hard foam support elements to one another
- Bit type PH3/PH2/PR2
- Note: select low speed, medium torque

##### Screw and washer fastening set – FIX-HS/-SB

- For the installation on supports

##### Hard plastic insert – FIX PRO-MAK

- For adhering to hard foam
- For the stable fastening, for example, of hose holders or fittings
- Available in the sizes:  
100 x 100 mm, 100 x 200 mm and 200 x 200 mm



FIX-KSD



FIX-FID



FIX-SD



FIX-SB

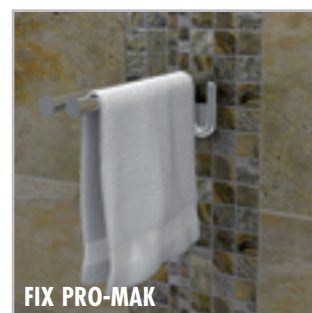

FIX PRO-MAK

## ■ PRODUCT AND PACKAGING SPECIFICATIONS – LUX ELEMENTS®-FIX

Online calculator see p. 7

	ARTICLE-NUMBER	ARTICLE-NAME / ARTICLE-DESCRIPTION	NOMINAL FORMAT/DIMENSIONS	CONTAINER / PACKAGING	WEIGHT / CONTAINER	CONTENTS INDIV. PACKAGING	UNIT	PRICE / UNIT €
	<b>LFIXZ1034</b>	<b>FIX-KSD 50</b> , plastic hammer fix plug	50 mm length	bag	0,25 kg	50 pieces	piece	0,86
	<b>LFIXZ1035</b>	<b>FIX-KSD 70</b> , plastic hammer fix plug	70 mm length	bag	0,30 kg	50 pieces	piece	0,91
	<b>LFIXZ1036</b>	<b>FIX-KSD 90</b> , plastic hammer fix plug	90 mm length	bag	0,40 kg	50 pieces	piece	0,97
	<b>LFIXZ2032</b>	<b>FIX-FID 80</b> , hammer fix plug	80 mm length	bag	0,15 kg	10 pieces	piece	0,98
	<b>LFIXZ2101</b>	<b>FIX-FID 80</b> , hammer fix plug	80 mm length	bag	0,70 kg	50 pieces	piece	0,82
	<b>LFIXZ1103</b>	<b>FIX-FID 110</b> , hammer fix plug	110 mm length	bag	0,21 kg	10 pieces	piece	1,00
	<b>LFIXZ1102</b>	<b>FIX-FID 110</b> , hammer fix plug	110 mm length	bag	1,10 kg	50 pieces	piece	0,89
	<b>LFIXZ1104</b>	<b>FIX-FID 140</b> , hammer fix plug	140 mm length	bag	1,70 kg	50 pieces	piece	1,06
	<b>LFIXZ1110</b>	<b>FIX-SD 80</b> , screw plug	80 mm length	bag	0,06 kg	10 pieces	piece	0,90
	<b>LFIXZ1010</b>	<b>FIX-SD 80</b> , screw plug	80 mm length	bag	0,34 kg	50 pieces	piece	0,80
	<b>LFIXZ1130</b>	<b>FIX-SD 130</b> , screw plug	130 mm length	bag	0,12 kg	10 pieces	piece	1,36
	<b>LFIXZ1030</b>	<b>FIX-SD 130</b> , screw plug	130 mm length	bag	0,70 kg	50 pieces	piece	1,23
	<b>LFIXZ1111</b>	<b>FIX-HS 80S70</b> , screw with washer for wooden substrate	screw: 80 mm length, washer: $\varnothing$ 70 mm	bag	1,36 kg	50 sets	set	1,15
	<b>LFIXZ1112</b>	<b>FIX-SB 45S35</b> , fastening sets with screw and washer	screw: 45 mm length, washer: $\varnothing$ 35 mm	bag	0,34 kg	50 sets	set	0,67
	<b>LFIXZ1113</b>	<b>FIX-SB 80S35</b> , fastening sets with screw and washer	screw: 80 mm length, washer: $\varnothing$ 35 mm	bag	0,70 kg	50 sets	set	0,98
	<b>LFIXZ1033</b>	<b>FIX-S 35</b> , washer, galvanised	$\varnothing$ 35 mm	bag	0,05 kg	10 pieces	piece	0,67
	<b>LFIXZ1114</b>	<b>FIX-S 35</b> , washer, galvanised	$\varnothing$ 35 mm	bag	0,15 kg	50 pieces	piece	0,63
	<b>LFIXZ1115</b>	<b>FIX-S 70</b> , washer, galvanised	$\varnothing$ 70 mm	bag	0,95 kg	50 pieces	piece	0,64
	<b>LFIXZ1025</b>	<b>FIX-S 60</b> , washer, stainless steel	$\varnothing$ 60 mm	bag	0,50 kg	50 pieces	piece	1,64
	<b>LFIXZ1200</b>	<b>FIX PRO-MAK 100/100</b> , hard plastic insert for stabilising fastenings	100 x 100 x 8 mm	carton	0,10 kg	1 piece	piece	40,60
	<b>LFIXZ1201</b>	<b>FIX PRO-MAK 100/200</b> , hard plastic insert for stabilising fastenings	100 x 200 x 8 mm	carton	0,12 kg	1 piece	piece	45,50
	<b>LFIXZ1202</b>	<b>FIX PRO-MAK 200/200</b> , hard plastic insert for stabilising fastenings	200 x 200 x 8 mm	carton	0,15 kg	1 piece	piece	49,68

Visit [www.luxelements.com](http://www.luxelements.com) for further information on FIX.

Data sheets, assembly instructions, test certificates and additional brochures under 'Downloads', videos under 'Practice' and on YouTube.

### Adhesives

#### COL

Adhesives and primers in a system with LUX ELEMENTS® hard foam support elements:

##### Primer – COL-HSV

- Solvent-free dispersion primer
- E.g. for wooden substrates
- For priming absorbing substrates
- As a preliminary wash primer for smooth and sealed substrates
- As moisture protection for calcium-sulphate bonded substrates



##### Fixing adhesive – COL-AK

- Ready-mixed dry mortar
- For the attachment, levelling and adhesion of LUX ELEMENTS® hard foam support elements
- Stable, fast bonding, waterproof
- Low on chromate in accordance with EC directive 2003/53/EC

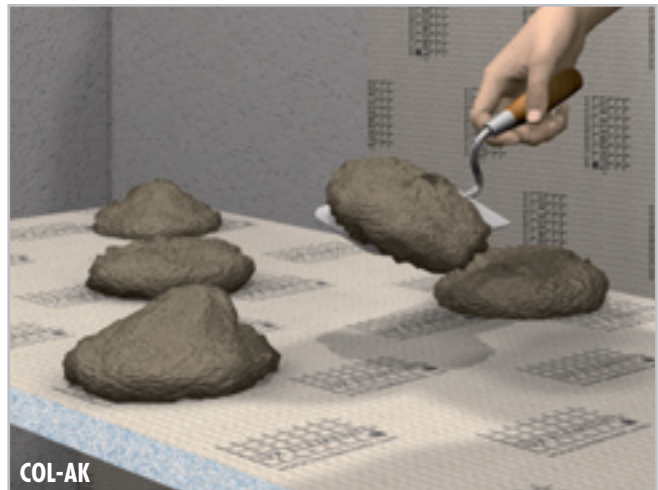



##### Mounting adhesive – COL-MK

- Moisture-curing, 1-component adhesive based on silane-terminated polymers
- For gluing of LUX ELEMENTS® hard foam support elements both to one another and to wood, wood materials, various metals, stone and ceramics
- Elastic when set, i.e. it is very well suited for stress-compensating bonding
- Also adheres in the presence of water (not underwater areas) with a sealing function
- Adheres to numerous substrates



■ PRODUCT AND PACKAGING SPECIFICATIONS – LUX ELEMENTS®-COL

Online calculator see p. 7

	ARTICLE-NUMBER	ARTICLE-NAME / ARTICLE-DESCRIPTION	CONTAINER / PACKAGING	WEIGHT / CONTAINER	CONTENTS INDIV. PACKAGING	CONTENTS COLLEC. PACKAGING	UNIT	PRICE / UNIT €
	LCOLZ1012	COL-HSV, dispersion-free primer	bottle	1 kg	1 kg		piece	19,44
	LCOLZ1003	COL-AK, fixing adhesive	bag	15 kg	15 kg		kg	2,92
	LCOLZ1004	COL-AK, fixing adhesive	euro pallet	960 kg		64 x 15 kg	kg	2,79
	LCOLZ1030	COL-MK, mounting adhesive	cartridge	0,5 kg	290 ml		piece	20,98
	LCOLZ1130	COL-MK, mounting adhesive	cardboard box	6 kg		12 x 290 ml	piece	16,99



Visit [www.luxelements.com](http://www.luxelements.com) for further information on COL.

Data sheets, assembly instructions, test certificates and additional brochures under 'Downloads', videos under 'Practice' and on YouTube.



## Sealing tapes and sealing filler **DRY**

Sealing tapes, films and tape sealers for the manufacture of watertight substrates in a system with LUX ELEMENTS® hard foam support elements:

### Sealing tape – DRY-DB

- Extremely thin, tear-resistant, elastic and vapour-permeable special tissue
- For connection sealing in conjunction with DRY-ASK sealing filler, DRY-DF sealing film or shower bases
- For wall/floor connections, inner corners, outer corners

### Sealing film – DRY-DF

- Extremely thin, tear-resistant special tissue
- For flat, alternative seals on the floor or on the wall
- Use in conjunction with DRY-DB sealing tape and DRY-ASK sealing filler for completion of the sealing at transitions and corners

### Expansion zone sleeve – DRY-DBDZM

- Expansion zone in the middle for various external pipe diameters
- Installation with DRY-ASK

### Sealing tape for ELEMENT-VK – DRY-DBV

- With sealing vapour-barrier properties
- For use on the fleece-backed ELEMENT-VK (see page 16), e.g. for sealing plate joints
- Also in the shape of inner corners DRY-DBVIE and outer corners DRY-DBVAE

### Cut protection tape – DRY-SB

- Self-adhesive, fixed-edge double-fabric tape with cut-resistant effect
- For the protection of the seal when renewing the permanently elastic service joint (e.g. silicone)

### Sealing filler – DRY-ASK

- Single-component, water-impermeable, crack-bridging and flexible sealing compound
- For large seals on LUX ELEMENTS® hard foam support elements

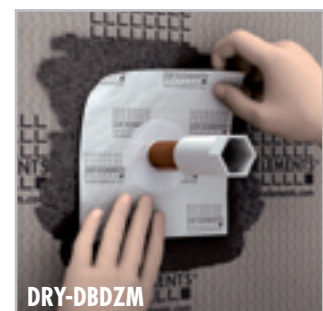
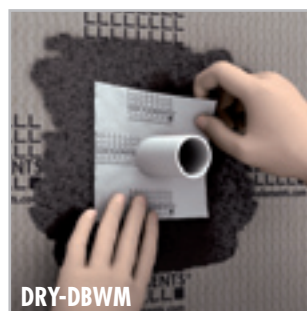



## ■ PRODUCT AND PACKAGING SPECIFICATIONS – LUX ELEMENTS®-DRY

Online calculator see p. 7 · \* standard-compliant according to DIN 18534

	ARTICLE-NUMBER	ARTICLE-NAME / ARTICLE-DESCRIPTION	NOMINAL FORMAT / DIMENSIONS	CONTAINER / PACKAGING	WEIGHT / CONTAINER	CONTENTS INDIV. PACKAGING	UNIT	PRICE / UNIT €
	LDRYZ1151	DRY-DB*, sealing tape	100 mm	roll	0,15 kg	5 m	m	5,63
	LDRYZ2001	DRY-DB*, sealing tape	100 mm	roll	0,4 kg	10 m	m	5,41
	LDRYZ2002	DRY-DB*, sealing tape	100 mm	roll	2,0 kg	50 m	m	4,10
	LDRYZ2014	DRY-DF*, sealing film	1000 mm	roll	4,2 kg	10 m	m	22,77
	LDRYZ2013	DRY-DF*, sealing film	1000 mm	roll	10,7 kg	30 m	m	16,61
	LDRYZ2103	DRY-DBIE*, sealing tape for inner corners		bag	0,045 kg	1 piece	piece	9,53
	LDRYZ2104	DRY-DBAE*, sealing tape for outer corners		bag	0,045 kg	1 piece	piece	9,53
	LDRYZ2105.L	DRY-DBIE LINE L*, sealing tape for inner corners, left, for TUB-LINE with one-sided gradient		bag	0,03 kg	1 piece	piece	11,28
	LDRYZ2105.R	DRY-DBIE LINE R*, sealing tape for inner corners, right, for TUB-LINE with one-sided gradient		bag	0,03 kg	1 piece	piece	11,28
	LDRYZ2206	DRY-DBWM*, Sealing sleeve for pipe openings	120/120 mm	bag	0,1 kg	4 pieces	piece	6,41
	LDRYZ2215	DRY-DBDZM 120*, expansion zone sleeve	120/120/25/8 mm	bag	0,12 kg	1 piece	piece	12,90
	LDRYZ2216	DRY-DBDZM 150*, expansion zone sleeve	150/150/60/20 mm	bag	0,14 kg	1 piece	piece	16,39
	LDRYZ3002	DRY-DBV*, sealing tape for ELEMENT-VK	120 mm	roll	0,5 kg	10 m	m	5,41
	LDRYZ3001	DRY-DBV*, sealing tape for ELEMENT-VK	120 mm	roll	1,5 kg	30 m	m	4,10
	LDRYZ3101	DRY-DBVIE*, sealing tape for ELEMENT-VK, inner corners		bag	0,043 kg	1 piece	piece	9,53
	LDRYZ3102	DRY-DBVAE*, sealing tape for ELEMENT-VK, outer corners		bag	0,043 kg	1 piece	piece	9,53
	LDRYZ4001	DRY-SB, cut protection tape	10 m	roll	0,4 kg	1 piece	m	18,85
	LDRYZ1016	DRY-ASK*, sealing filler		bag	3,5 kg		kg	10,95
	LDRYZ1015	DRY-ASK*, sealing filler		bag	15 kg		kg	9,08

 Visit [www.luxelements.com](http://www.luxelements.com) for further information on DRY.

Data sheets, assembly instructions, test certificates and additional brochures under 'Downloads', videos under 'Practice' and on YouTube.

### Reinforcement fabric

#### **ARM**

Reinforcement fabric in a system with LUX ELEMENTS® hard foam support elements:

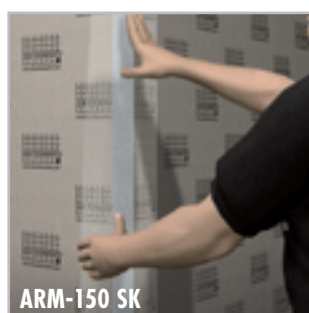

Application areas:

- Board joints
- Transitions
- Surfaces
- Corners



### ■ PRODUCT AND PACKAGING SPECIFICATIONS – LUX ELEMENTS®-ARM

Online calculator see p. 7

	ARTICLE-NUMBER	ARTICLE-NAME / ARTICLE-DESCRIPTION	NOMINAL FORMAT/ DIMENSIONS	CONTAINER / PACKAGING	WEIGHT / CONTAINER	CONTENTS INDIV. PACKAGING	UNIT	PRICE / UNIT €
	<b>LARMZ1006</b>	<b>ARM-100 SK</b> , reinforcement for transitions *	100 mm	roll	0,1 kg	10 m	m	1,32
	<b>LARMZ1007</b>	<b>ARM-100 SK</b> , reinforcement for transitions *	100 mm	roll	0,2 kg	20 m	m	1,19
	<b>LARMZ1001</b>	<b>ARM-100 SK</b> , reinforcement for transitions *	100 mm	roll	0,5 kg	90 m	m	0,93
	<b>LARMZ1002</b>	<b>ARM-150 SK</b> , reinforcement for corners *	150 mm	roll	1,0 kg	50 m	m	1,32
	<b>LARMZ1012</b>	<b>ARM-600</b> , reinforcement for surfaces	600 mm	roll	0,2 kg	2,5 m	m	3,14
	<b>LARMZ1004</b>	<b>ARM-600</b> , reinforcement for surfaces	600 mm	roll	1,5 kg	20 m	m	2,12

\* self-adhesive design



Visit [www.luxelements.com](http://www.luxelements.com) for further information on ARM.

Data sheets, assembly instructions, test certificates and additional brochures under 'Downloads', videos under 'Practice' and on YouTube.

### Mounting aids **MONT**

Mounting aids in a system with LUX ELEMENTS® hard foam support elements:

#### **MONT-UNI and -H**

- For connecting LUX ELEMENTS® hard foam support elements to one another
- For mounting on the wall or floor
- For the extension of walls

#### **MONT-TOPFIX**

- For adjusting bath tub claddings (see TOP page 34)



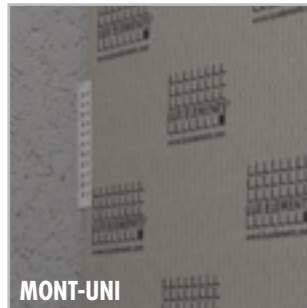

#### **MONT-TOPREV**

- For insertion of inspection openings (see TOP page 36)



■ PRODUCT AND PACKAGING SPECIFICATIONS – LUX ELEMENTS®-MONT

Online calculator see p. 7

	ARTICLE-NUMBER	ARTICLE-NAME / ARTICLE-DESCRIPTION	CONTAINER / PACKAGING	WEIGHT / CONTAINER	CONTENTS INDIV, PACKAGING	UNIT	PRICE / UNIT €
	<b>LMONZ1117</b>	<b>MONT-UNI 50</b> , U-shape mounting aid	bag	0,35 kg	4 pieces	piece	4,79
	<b>LMONZ1110</b>	<b>MONT-UNI 80</b> , U-shape mounting aid	bag	0,42 kg	4 pieces	piece	5,03
	<b>LMONZ1108</b>	<b>MONT-H 50</b> , mounting aid for connecting two elements	bag	0,68 kg	4 pieces	piece	9,62
	<b>LMONZ1113</b>	<b>MONT-H 80</b> , mounting aid for connecting two elements	bag	0,92 kg	4 pieces	piece	10,98
	<b>LMONZ1015</b>	<b>MONT-TOPFIX</b> , adjustable foot for bath surrounds	bag	0,28 kg	6 pieces	piece	5,59
	<b>LMONZ1009</b>	<b>MONT-TOPREV</b> , mounting aid for maintenance openings for bath tubs consisting of 2 parts for top and bottom	bag	0,25 kg	1 set	set	12,17



Visit [www.luxelements.com](http://www.luxelements.com) for further information on MONT.

Data sheets, assembly instructions, test certificates and additional brochures under 'Downloads', videos under 'Practice' and on YouTube.

# LUX ELEMENTS – Systems for bathroom and showers

## Bathroom design

Here you will find all LUX ELEMENTS products for bathroom design as a supplement to bathroom construction (from page 10). Whether claddings for installations and bath tubs or separate components such as washstands, bath tub construction kits, niches, bench seats or partition walls: all products are both design element and substrate for tiles, panels and plaster.



# Bathroom design – Content



## Installation cladding

Pipe cladding elements – TEC-KA / TEC-U .....	32
Cladding of pre-wall installation systems – TEC-VWD .....	32



## Bath surrounds

Bath tub surrounds for rectangular standard bath tubs – TOP-TR .....	34
Removable whirlpool cladding – TOP-WP .....	38



## Washstands

Washstands – LAVADO-FLOAT .....	40
---------------------------------	----



## Bath tubs

Bath tubs – RELAX-BW .....	42
----------------------------	----



## Niches

Niches – RELAX-NI .....	44
-------------------------	----



## Benches

Benches – RELAX-BA .....	46
--------------------------	----



## Shower partition walls

Shower partition wall – RELAX-TW .....	56
--	----



Pipe cladding elements

**TEC-KA / TEC-U**

- Cladding of conduits, pipes, joists, girders, beams and columns
- Application in corners or on straight surfaces



Cladding of pre-wall installation systems

**TEC-VWD-PS**

- Prefabricated element 1250 x 600 x 20 mm
- With 4 holes

**TEC-VWD-E**

- Element 1250 x 1200 x 20 mm
- Without holes
- In addition to VWD-PS / -P / -PV

**TEC-VWD-P**

- Prefabricated element 1250 x 1200 x 20 mm
- With 4 holes



**TEC-VWD-PV**

- Prefabricated element 1250 x 1200 x 20 mm
- With 4 holes
- With reinforcing panel installed on rear side
- Suitable for top coverings without load distribution function
- Continuous surface on the front side

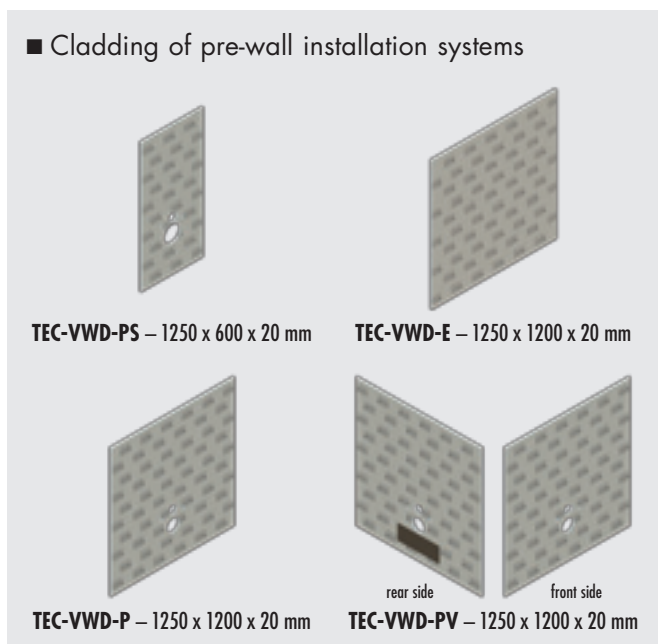





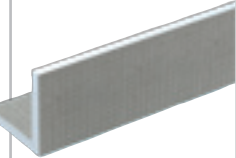
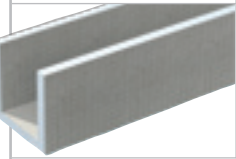

## ■ PRODUCT SPECIFICATIONS – LUX ELEMENTS®-TEC

Packaging specifications see p. 139 · Online calculator see p. 7 · \* standard-compliant according to DIN 18534

ARTICLE-NUMBER	ARTICLE-NAME / ARTICLE-DESCRIPTION	NOMINAL FORMATS/DIMENSIONS a x b x LENGTH x THICKNESS	UNIT	PRICE / UNIT €
	<b>TEC-KA BS</b>			
	<b>TEC-U BS</b>			

Pipe cladding elements		a x b x length x thickness			
	<b>LTECX1001</b>	<b>TEC-KA 15 BS*</b> , angular pipe cladding element, coated on both sides	150 x 150 x 2500 x 20 mm	piece	46,71
	<b>LTECX1002</b>	<b>TEC-KA 20 BS*</b> , angular pipe cladding element, coated on both sides	200 x 200 x 2500 x 20 mm	piece	64,90
	<b>LTECX1003</b>	<b>TEC-KA 30 BS*</b> , angular pipe cladding element, coated on both sides	300 x 300 x 2500 x 20 mm	piece	79,47
	<b>LTECX1004</b>	<b>TEC-KA 40 BS*</b> , angular pipe cladding element, coated on both sides	200 x 400 x 2500 x 20 mm	piece	79,47
	<b>LTECX1010</b>	<b>TEC-U 20 BS*</b> , U-shaped pipe cladding element, straight, coated both sides	400 x 200 x 2500 x 20 mm	piece	100,85
Cladding of pre-wall installation systems		length x width x thickness			
	<b>LTECX5003</b>	<b>TEC-VWD-PS</b> , prefabricated element made of hard foam support material for cladding of pre-wall installation systems with 4 holes	1250 x 600 x 20 mm	piece	63,39
	<b>LTECX5004</b>	<b>TEC-VWD-E</b> , element made of hard foam support material for cladding of pre-wall installation systems without holes	1250 x 1200 x 20 mm	piece	78,57
	<b>LTECX5002</b>	<b>TEC-VWD-P</b> , prefabricated element made of hard foam support material for cladding of pre-wall installation systems with 4 holes	1250 x 1200 x 20 mm	piece	78,92
	<b>LTECX5005</b>	<b>TEC-VWD-PV</b> , prefabricated element made of hard foam support material for cladding of pre-wall installation systems with 4 holes, with reinforcing panel installed on rear side	1250 x 1200 x 20 mm	piece	96,14



LUX ELEMENTS manufactures individual customised and special products for TEC.

These include dimensions, thicknesses, shapes etc. that deviate from the standard programme. For more information see page 5.



Visit [www.luxelements.com](http://www.luxelements.com) for further information on TEC.

Data sheets, assembly instructions, test certificates and additional brochures under 'Downloads', videos under 'Practice' and on YouTube.

Bath tub surrounds for rectangular standard bath tubs

**TOP-TR...**

- Cladding elements for standard bath tubs
- Three design variants: Cladding elements for ...
  - Surrounds for smooth and flush bath cladding – TOP-TRS
  - Surrounds with footboard – TOP-TRU
  - Surrounds with ledge – TOP-TRV
- Included MONT-TOPFIX for adjusting bath tub claddings
- Light (for TOP-TRU), inspection options and mounting aids, see page 36



■ Installation situations

For the three design variants the following installation positions are possible:

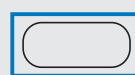

Free-standing

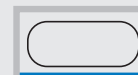

Niche installation

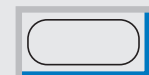

Corner installation

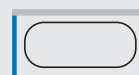

3-sided installation



Installation with shelf

■ **PRODUCT SPECIFICATIONS – LUX ELEMENTS®-TOP**

Packaging specifications see p. 139 · Online calculator see p. 7 · \* standard-compliant according to DIN 18534

ARTICLE-NUMBER	ARTICLE-NAME / ARTICLE-DESCRIPTION	NOMINAL FORMATS/DIMENSIONS LENGTH x WIDTH x THICKNESS	UNIT	PRICE / UNIT €
----------------	------------------------------------	---	------	----------------

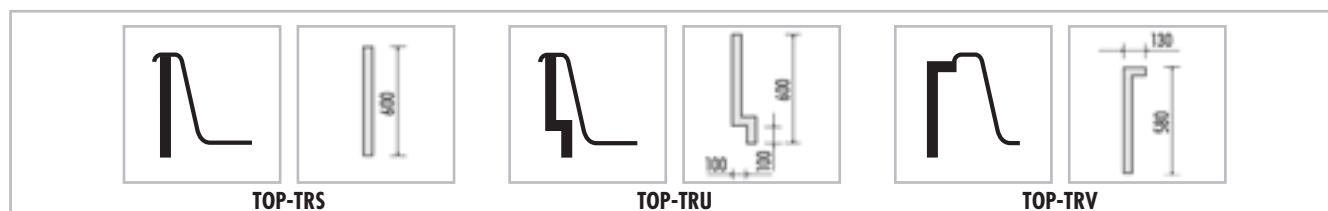

	LTOPE1002	<b>TOP-TRS 1685 S</b> , surround for bath tubs up to 1700 mm	1685 x 600 x 30 mm	piece	68,85
	LTOPE1004	<b>TOP-TRS 1785 S</b> , surround for bath tubs up to 1800 mm	1785 x 600 x 30 mm	piece	71,91
	LTOPE1054	<b>TOP-TRS 1860 S</b> , surround for bath tubs up to 1900 mm	1860 x 600 x 30 mm	piece	81,09
	LTOPE1006	<b>TOP-TRS 2100 S</b> , surround for bath tubs up to 2100 mm or tubs with foot-end shelving	2100 x 600 x 30 mm	piece	90,27
	LTOPE1010	<b>TOP-TRS 800 S</b> , surround for bath tub head end	800 x 600 x 30 mm	piece	38,71
	LTOPE1055	<b>TOP-TRS 900 S</b> , surround for bath tub head end	900 x 600 x 30 mm	piece	40,86
	LTOPE1017	<b>TOP-TRU 2100 S</b> , surround with footboard for bath tubs up to 2100 mm or bath tubs with foot-end shelving	2100 x 600 x 30 mm	piece	131,60
	LTOPE1021	<b>TOP-TRU 900 S</b> , surround for bath tub head end	900 x 600 x 30 mm	piece	50,26
	LTOPE1023	<b>TOP-TRV 2100 S</b> , surround with ledge for bath tubs up to 2100 mm	2100 x 580 x 30 mm	piece	122,40
	LTOPE1029	<b>TOP-TRV 900 li S</b> , surround with ledge for left hand bath tub head end	900 x 580 x 30 mm	piece	76,67
	LTOPE1031	<b>TOP-TRV 900 re S</b> , surround with ledge for right hand bath tub head end	900 x 580 x 30 mm	piece	76,67

**Please note:** Bath tub surrounds for standard rectangular tubs are not available as kits. Depending on the installation situation as many as 4 elements are needed.



LUX ELEMENTS manufactures individual customised and special products for TOP.

These include dimensions, thicknesses, shapes etc. that deviate from the standard programme. For more information see page 5.



Visit [www.luxelements.com](http://www.luxelements.com) for further information on TOP.

Data sheets, assembly instructions, test certificates and additional brochures under 'Downloads', videos under 'Practice' and on YouTube.

Light for bath surrounds TOP-TRU

### TOP-TRU LI-WW 2100

- Light rope set, for TOP-TRU 2100 S



Inspection options and mounting aids

### TOP-REVR

- Made to measure maintenance openings on the head end and longitudinal side with the TRV design variant
- Arbitrary size, adaptable to the tile grid size
- Fast opening and closing due to magnetic closure

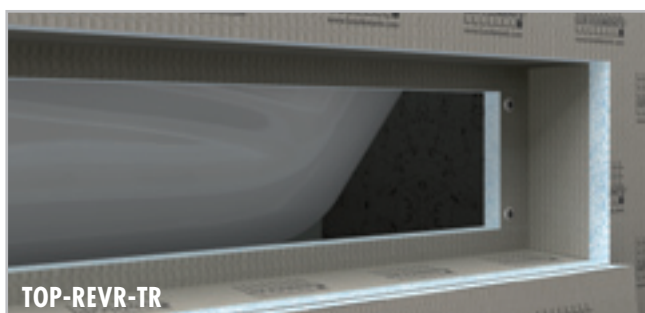

### MONT-TOPREV

- Fixing profile for mounting for maintenance openings in an arbitrary size adaptable to the tile grid size
- Simple, fast and flexible





### TOP-KIT

- Complete mounting accessories for bath tub claddings



■ **PRODUCT SPECIFICATIONS – LUX ELEMENTS®-TOP**

Packaging specifications see p. 139 · Online calculator see p. 7

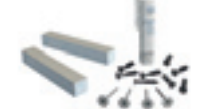
	ARTICLE-NUMBER	ARTICLE-NAME / ARTICLE-DESCRIPTION	UNIT	PRICE / UNIT €
	<b>LTOPELL1017</b>	<b>TOP-TRU LI-WW 2100</b> , LED light rope warm white, protection class IP 67, 24 V, 5 m supply cable, for TOP-TRU 2100 S, incl. power supply unit	set	290,99
	<b>LTOPE1051</b>	<b>TOP-REVR-TR</b> , recessed, removable maintenance opening integrated into the front or side wall, for all TRV model design variants, made to measure	piece	226,24
	<b>LMONZ1009</b>	<b>MONT-TOPREV</b> , mounting aid for maintenance openings for bath tubs consisting of 2 parts for top and bottom	set	12,17
	<b>LTOPE1053</b>	<b>TOP-KIT</b> , mounting kit for cladding elements: 2 rabbets made of hard foam support element 350 x 50 x 50 mm, 4 pieces FIX-FID 110, 8 pieces FIX-SD 80, 1 cartridge COL-MK	kit	35,15



LUX ELEMENTS manufactures individual customised and special products for TOP.

These include dimensions, thicknesses, shapes etc. that deviate from the standard programme. For more information see page 5.



Visit [www.luxelements.com](http://www.luxelements.com) for further information on TOP.

Data sheets, assembly instructions, test certificates and additional brochures under 'Downloads', videos under 'Practice' and on YouTube.

## Removable whirlpool cladding

### TOP-WP...

- With footboard and ledge
- Mounting by means of metal plug connection
- Additionally held by magnets in case of round shapes
- Easily removable for maintenance and repair
- Available as a made to measure product



#### ■ Whirlpool shapes

(All whirlpool claddings are equipped with footboard and ledge)

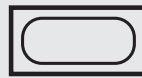

for rectangular and straight shapes – TOP-WP G



for quadrant shapes – TOP-WP V



for hexagonale shapes – TOP-WP S



for oval shapes – TOP-WP O



for trapezoidal shapes – TOP-WP T

#### Platform for corner installation – TOP-WP P

- Suitable for whirlpool cladding TOP-WP S 1900
- For compensation of the cavity behind the whirlpool tub
- Suitable for use as a shelf



#### LED lighting – TOP-WP LI

- LED light rope warm white
- Made-to-measure for each whirlpool cladding

#### Maintenance opening – TOP-WP REV 300

- Supplied loose, incl. appropriate milling in the whirlpool cladding

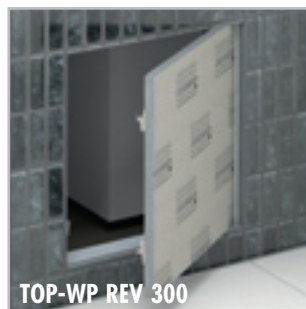

#### Mounting aids – TOP-KIT-WP

- Complete mounting accessories for whirlpool claddings

**■ PRODUCT SPECIFICATIONS – LUX ELEMENTS®-TOP**

Packaging specifications on request · Online calculator see p. 7 · \* standard-compliant according to DIN 18534

ARTICLE-NUMBER	ARTICLE-NAME / ARTICLE-DESCRIPTION	NOMINAL FORMATS/DIMENSIONS LENGTH x WIDTH x THICKNESS	UNIT	PRICE / UNIT €
<b>TOP-WP</b> , whirlpool cladding with footboard, ledge and removable				
 LTOPE11001	<b>TOP-WP G 1900</b> , whirlpool cladding 1x long side, for rectangular and straight shapes, tub length up to 1900 mm, tub width up to 900 mm	made to measure	set	783,70
LTOPE11002	<b>TOP-WP G 1900/900</b> , whirlpool cladding 1x head- and 1x long side, for rectangular and straight shapes, tub length up to 1900 mm, tub width up to 900 mm	made to measure	set	1.130,40
LTOPE12001	<b>TOP-WP V 1500</b> , whirlpool cladding 1x quadrant side, for quadrant shapes, tub length and width up to 1500 mm	made to measure	set	1.777,99
LTOPE13001	<b>TOP-WP S 1900</b> , whirlpool cladding 2x head- and 1x long side, for hexagonal shapes, tub length up to 1900 mm, tub width up to 900 mm	made to measure	set	1.269,98
LTOPE14001	<b>TOP-WP O 1900/900</b> , whirlpool cladding 1x oval side and 1x long side, for oval shapes, tub length up to 1900 mm, tub width up to 900 mm	made to measure	set	1.812,25
LTOPE15001	<b>TOP-WP T 1900/900</b> , whirlpool cladding 1x head- and 1x long side, for trapezoidal shapes, tub length up to 1900 mm, tub width up to 900 mm	made to measure	set	1.146,95
<b>Platform for corner installation</b>				
 LTOPE13002	<b>TOP-WP P</b> , Platform for corner installation, for whirlpool cladding TOP-WP S 1900, for compensation of the cavity behind the whirlpool tub	made to measure	set	429,87
<b>TOP-WP LI-WW</b> , LED light rope warm white, protection class IP 67, 24 V, 5 m supply cable, incl. power supply unit				
 LTOPE11011	<b>TOP-WP LI-WW G 1900</b> , for whirlpool cladding TOP-WP G 1900	made to measure	set	276,47
LTOPE11012	<b>TOP-WP LI-WW G 1900/900</b> , for whirlpool cladding TOP-WP G 1900/900	made to measure	set	376,67
LTOPE12011	<b>TOP-WP LI-WW V 1500</b> , for whirlpool cladding TOP-WP V 1500	made to measure	set	326,76
LTOPE13011	<b>TOP-WP LI-WW S 1900</b> , for whirlpool cladding TOP-WP S 1900	made to measure	set	403,66
LTOPE14011	<b>TOP-WP LI-WW O 1900/900</b> , for whirlpool cladding TOP-WP O 1900/900	made to measure	set	330,35
LTOPE15011	<b>TOP-WP LI-WW T 1900/900</b> , for whirlpool cladding TOP-WP T 1900/900	made to measure	set	360,34
<b>Maintenance opening / mounting kit</b>				
 LTOPE16000	<b>TOP-WP REV 300</b> , maintenance opening, supplied loose, incl. appropriate milling in the whirlpool cladding and fillers for covering thicknesses of 2 or 12 mm	300 x 300 mm	surcharge	179,96
 LTOPE10005	<b>TOP-KIT WP</b> , mounting kit for whirlpool claddings: 10 pieces FIX-FID 110, 20 pieces FIX-SD 80, 1 cartridge COL-MK		kit	40,63



LUX ELEMENTS manufactures individual customised and special products for TOP.

These include dimensions, thicknesses, shapes etc. that deviate from the standard programme. For more information see page 5.

 Visit [www.luxelements.com](http://www.luxelements.com) for further information on TOP.

Data sheets, assembly instructions, test certificates and additional brochures under 'Downloads', videos under 'Practice' and on YouTube.

## Washstands

### LAVADO-FLOAT

- Stable suspension on stainless steel brackets
- Can be shortened at the sides
- Installation possible on masonry and stud frames
- With channel drain: The system offers two design options due to a reversible channel cover rail
- Barrier-free: drive-under washing place
- In standard format or made to measure
- Optional: light rope, for the indirect lighting of the long side underneath the washstand, see page 41



#### ■ System components – LAVADO-FLOAT G

Stainless steel brackets – 450 mm long

Washstand panel – hard foam support material, even

Mounting adhesive –  
1 cartridge COL-MK  
290 ml (see p. 22)



#### ■ System components – LAVADO-FLOAT L

Cover rail – brushed stainless steel, tileable on the rear side

Tiling aid – brushed stainless steel, for clean tiling

Height adapter – separately provided, can be cut as required

Fillers – for flush tiling up to the edge of the channel

Stainless steel brackets – 450 mm long

Channel drain with click system –  
for the firm connection with separate drain support

Washstand panel – hard foam support material, with sloping recess

Drain support – clip-on technique, for drain pipe 1 1/4"

Mounting adhesive –  
1 cartridge COL-MK  
290 ml (see p. 22)





## ■ PRODUCT SPECIFICATIONS – LUX ELEMENTS®-LAVADO

Packaging specifications see p. 140

ARTICLE-NUMBER	ARTICLE-NAME / ARTICLE-DESCRIPTION	NOMINAL FORMATS/DIMENSIONS WIDTH x DEPTH x HEIGHT	UNIT	PRICE / UNIT €
 				
<b>LAVADO-FLOAT G</b>		<b>LAVADO-FLOAT L</b>		
<b>Washstand even</b>				
				
<b>LAVADO-FLOAT G</b> , washstand, even, without recess, incl. 1 cartridge COL-MK and stainless steel brackets 450 mm in length				
<b>LLAVE5001</b>	<b>LAVADO-FLOAT G</b> , as set for single washing facility, incl. 2 stainless steel brackets 450 mm in length, standard format	1170 x 585 x 100 mm	set	624,18
<b>LLAVE5101</b>	<b>LAVADO-FLOAT ONE G</b> , as set for single washing facility, incl. 2 stainless steel brackets 450 mm in length, made to measure	max. width 1500 mm, max. depth 585 mm, height 100 mm	set	759,17
<b>LLAVE5201</b>	<b>LAVADO-FLOAT TWO G</b> , as a set for double washing facility, incl. 3 stainless steel brackets 450 mm in length, made to measure	max. width 2400 mm, max. depth 585 mm, height 100 mm	set	1.182,79
<b>Washstand with channel drain</b>				
				
<b>LAVADO-FLOAT L</b> , washstand, with sloping recess, with channel drain 70 x 650 mm, integrated in hard foam support material, with cover rail and tiling aid made of brushed stainless steel, cover rail tileable on the rear side, height adjustable with height adapter from 5 – 17 mm, incl. fillers for tiling up to the edge of the channel, incl. clip-on drainage adapter for drain pipe 1 ¼", incl. 1 cartridge COL-MK and stainless steel brackets 450 mm in length				
<b>LLAVE5005</b>	<b>LAVADO-FLOAT L</b> , as set for single washing facility, incl. 2 stainless steel brackets 450 mm in length standard format	1170 x 585 x 100 mm	set	1.105,86
<b>LLAVE5105</b>	<b>LAVADO-FLOAT ONE L</b> , as set for single washing facility, incl. 2 stainless steel brackets 450 mm in length, made to measure	max. width 1500 mm, max. depth 585 mm, height 100 mm	set	1.268,00
<b>LLAVE5205</b>	<b>LAVADO-FLOAT TWO L</b> , as a set for double washing facility, incl. 3 stainless steel brackets 450 mm in length, made to measure	max. width 2400 mm, max. depth 585 mm, height 100 mm	set	2.097,67
<b>Light</b>				
				
<b>LAVADO-FLOAT LI-WW</b> , LED light rope warm white, for the indirect lighting of the long side underneath the washstand, protection class IP 67, 24 V, 5 m supply cable, incl. power supply unit				
<b>LLAVE5011</b>	<b>LAVADO-FLOAT LI-WW 1170</b> , for LAVADO-FLOAT G and L, standard format	length 1100 mm	set	240,23
<b>LLAVE5111</b>	<b>LAVADO-FLOAT LI-WW ONE</b> , for LAVADO-FLOAT ONE, made to measure	max. length 1430 mm	set	263,40
<b>LLAVE5211</b>	<b>LAVADO-FLOAT LI-WW TWO</b> , for LAVADO-FLOAT TWO, made to measure	max. length 2330 mm	set	366,08



LUX ELEMENTS manufactures individual customised and special products for LAVADO.

These include dimensions, thicknesses, shapes etc. that deviate from the standard programme. For more information see page 5.

 Visit [www.luxelements.com](http://www.luxelements.com) for further information on LAVADO.

Data sheets, assembly instructions, test certificates and additional brochures under 'Downloads', videos under 'Practice' and on YouTube.

### Bath tubs

#### RELAX-BW

- Construction kit for tileable bath tub
- Including drain and overflow fitting
- Two size graduations
- Optional built-in elements, e.g. head rest



#### ■ Inlay elements

The inlay elements, with the variants 'Headrest' and 'Triangle' can be installed on one or both sides:

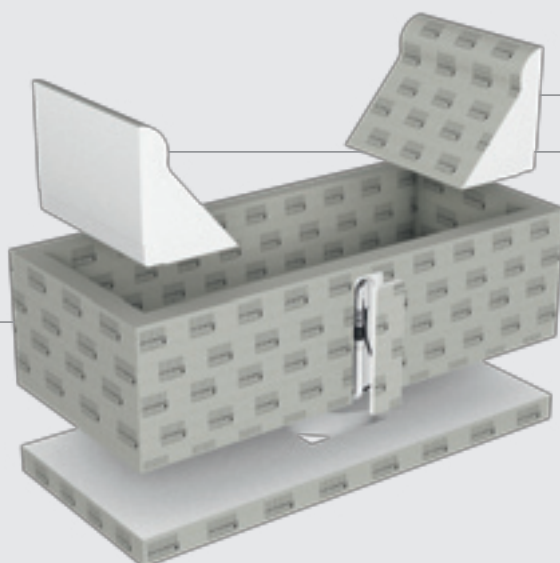





or



■ PRODUCT SPECIFICATIONS – LUX ELEMENTS®-RELAX-BW

Packaging specifications on request

	ARTICLE-NUMBER	ARTICLE-NAME / ARTICLE-DESCRIPTION	NOMINAL FORMATS/DIMENSIONS LENGTH x WIDTH x HEIGHT	UNIT	PRICE / UNIT €
	LREL3001	RELAX-BW 1800–2000, bath tub construction kit, tileable, incl. drain and overflow fitting and base element	1800–2000 x 800 x 600 mm	piece	2.463,21
	LREL3002	RELAX-BW 2001–2200, bath tub construction kit, tileable, incl. drain and overflow fitting and base element	2001–2200 x 800 x 600 mm	piece	2.644,64
	LREL3101	RELAX-BW EK, bath tub mounting part suitable for both tub sides, 'head rest' design	357 x 630 x 455 mm	piece	226,74
	LREL3102	RELAX-BW ED, bath tub mounting part suitable for both tub sides, 'triangle' design	300 x 630 x 455 mm	piece	170,51
	LREL3901	RELAX-KIT BW, mounting kit for RELAX-BW: 22 kg DRY-ASK (1x 15 kg + 2x 3,5 kg), 10 m DRY-DB, 4 pieces DRY-DBIE, 2 cartridges COL-MK, 10 m ARM-100 SK, 25 kg COL-AK		Kit	430,11



LUX ELEMENTS manufactures individual customised and special products for RELAX.

These include dimensions, thicknesses, shapes etc. that deviate from the standard programme. For more information see page 5.



Visit [www.luxelements.com](http://www.luxelements.com) for further information on RELAX.

Data sheets, assembly instructions, test certificates and additional brochures under 'Downloads', videos under 'Practice' and on YouTube.



## Niches

### RELAX-NI

- Prefabricated niches with or without shelf
- Space-saving place to keep things in the shower and bathroom
- Design and function in a single product
- Various sizes
- Vertical or horizontal installation
- Optimally combinable with ELEMENT construction panel
- Matching, optional lighting technology, see page 45





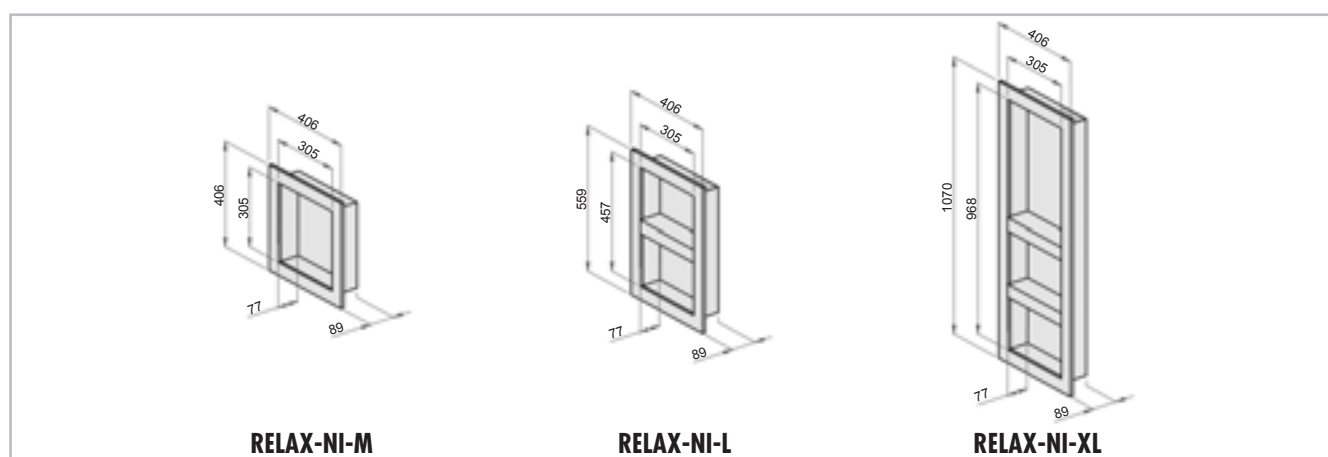

■ **PRODUCT SPECIFICATIONS – LUX ELEMENTS®-RELAX-NI**

Packaging specifications see p. 140 · \* standard-compliant according to DIN 18534

ARTICLE-NUMBER	ARTICLE-NAME / ARTICLE-DESCRIPTION	NOMINAL FORMATS/DIMENSIONS LENGTH x WIDTH x HEIGHT	UNIT	PRICE / UNIT €
----------------	------------------------------------	--	------	----------------



	<b>LREL8201</b>	<b>RELAX-NI-M*</b> , prefabricated niche made of hard foam support material	406 x 406 x 89 mm	piece	102,97
	<b>LREL8202</b>	<b>RELAX-NI-L*</b> , prefabricated niche made of hard foam support material, including 1 loose shelf	559 x 406 x 89 mm	piece	116,32
	<b>LREL8203</b>	<b>RELAX-NI-XL*</b> , prefabricated niche made of hard foam support material, including 2 loose shelves	1070 x 406 x 89 mm	piece	173,62
	<b>RELAX-NI LI-WW</b> , LED light rope warm white, protection class IP 67, 24 V, 5 m supply cable, incl. power supply unit				
	<b>LREL8211</b>	<b>RELAX-NI LI-WW 300</b> , for RELAX-NI-M, L and XL (vertical installation)	length 300 mm	set	167,61
	<b>LREL8212</b>	<b>RELAX-NI LI-WW 450</b> , for RELAX-NI-L (horizontal installation)	length 450 mm	set	178,50
	<b>LREL8213</b>	<b>RELAX-NI LI-WW 950</b> , for RELAX-NI-XL (horizontal installation)	length 950 mm	set	214,79



LUX ELEMENTS manufactures individual customised and special products for RELAX.

These include dimensions, thicknesses, shapes etc. that deviate from the standard programme. For more information see page 5.



Visit [www.luxelements.com](http://www.luxelements.com) for further information on RELAX.

Data sheets, assembly instructions, test certificates and additional brochures under 'Downloads', videos under 'Practice' and on YouTube.

**Benches**

**RELAX-BA**

- Prefabricated bench seats for bathroom and shower areas as building kit
- For use in front of the wall
- Choice of three bench shapes: **SOLO**, **SHAPE** and **SIZE**
- Three lengths to fit showers as bathtub replacement TUB-BOL (from page 58)
- Optionally available (see page 50):
  - backrest in two design variants
  - factory-installed seat heating
  - light rope for bench form **SHAPE** and **SIZE**

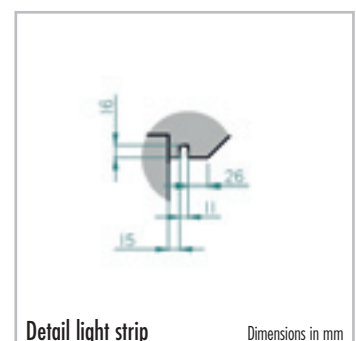
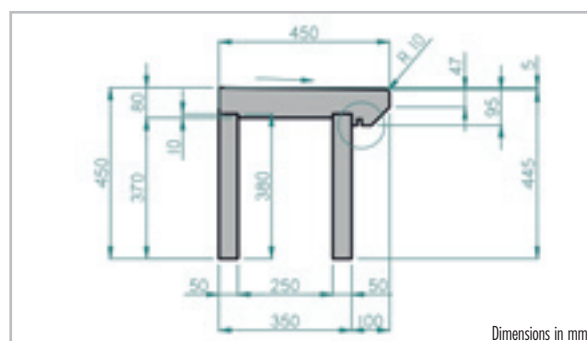
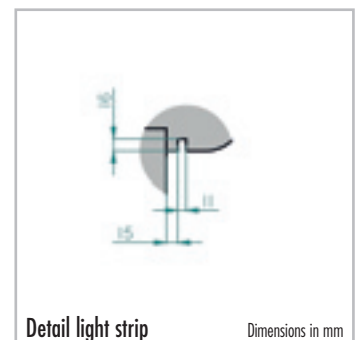
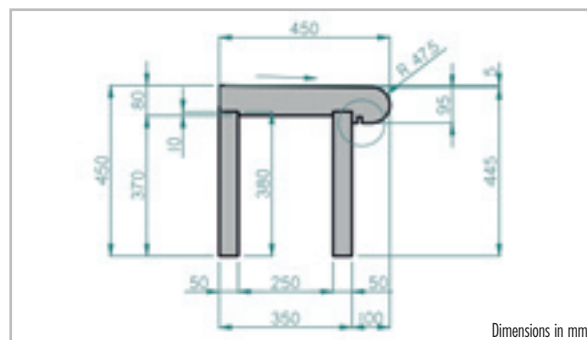
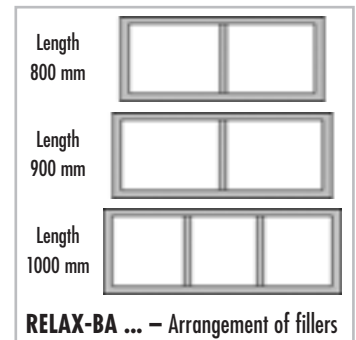
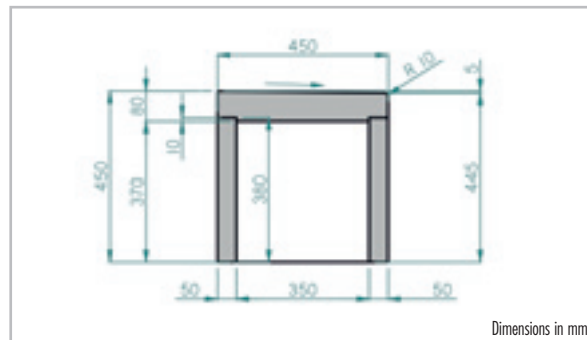

■ PRODUCT SPECIFICATIONS – LUX ELEMENTS®-RELAX-BA

Packaging specifications see p. 140

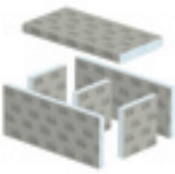
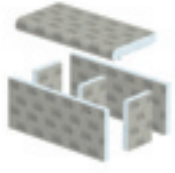
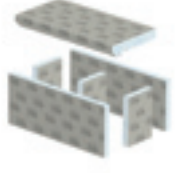
	ARTICLE-NUMBER	ARTICLE-NAME / ARTICLE-DESCRIPTION	NOMINAL FORMATS/DIMENSIONS LENGTH x WIDTH x HEIGHT	UNIT	PRICE / UNIT €
<b>Bench form SOLO</b>					
	LREL8500	RELAX-BA SOLO 800, bench form SOLO, straight, 800 mm long, as building kit	800 x 450 x 450 mm	set	328,44
	LREL8501	RELAX-BA SOLO 900, bench form SOLO, straight, 900 mm long, as building kit	900 x 450 x 450 mm	set	365,37
	LREL8502	RELAX-BA SOLO 1000, bench form SOLO, straight, 1000 mm long, as building kit	1000 x 450 x 450 mm	set	405,96
<b>Bench form SHAPE</b>					
	LREL8503	RELAX-BA SHAPE 800, bench form SHAPE, straight, 800 mm long, as building kit	800 x 450 x 450 mm	set	328,44
	LREL8504	RELAX-BA SHAPE 900, bench form SHAPE, straight, 900 mm long, as building kit	900 x 450 x 450 mm	set	365,37
	LREL8505	RELAX-BA SHAPE 1000, bench form SHAPE, straight, 1000 mm long, as building kit	1000 x 450 x 450 mm	set	405,96
<b>Bench form SIZE</b>					
	LREL8506	RELAX-BA SIZE 800, bench form SIZE, straight, 800 mm long, as building kit	800 x 450 x 450 mm	set	328,44
	LREL8507	RELAX-BA SIZE 900, bench form SIZE, straight, 900 mm long, as building kit	900 x 450 x 450 mm	set	365,37
	LREL8508	RELAX-BA SIZE 1000, bench form SIZE, straight, 1000 mm long, as building kit	1000 x 450 x 450 mm	set	405,96



LUX ELEMENTS manufactures individual customised and special products for RELAX.

These include dimensions, thicknesses, shapes etc. that deviate from the standard programme. For more information see page 5.



Visit [www.luxelements.com](http://www.luxelements.com) for further information on RELAX.

Data sheets, assembly instructions, test certificates and additional brochures under 'Downloads', videos under 'Practice' and on YouTube.

### Benches

#### RELAX-BA-CO FLOAT

- Prefabricated bench seats for bathroom and shower areas
- For use in corners
- Choice of two sizes
- Floating design
- Including mounting accessories

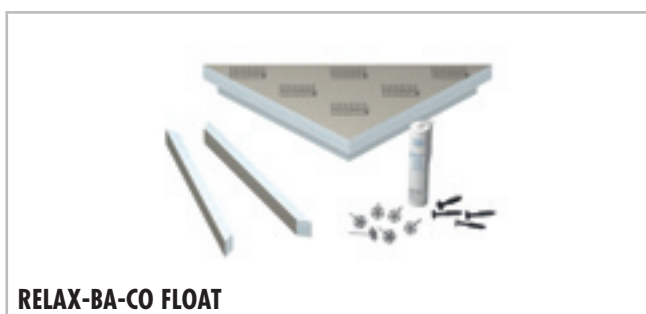
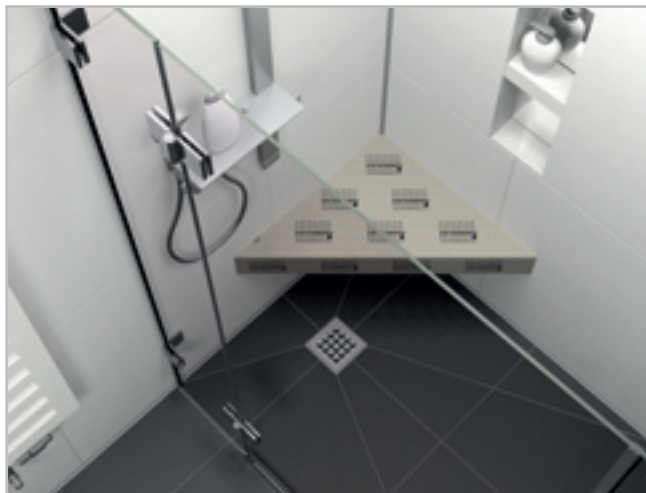

RELAX-BA-CO FLOAT

### Benches

#### RELAX-BA FLOAT

- Prefabricated bench seats for bathroom and shower areas
- For use in a niche
- Choice of three lengths
- Floating design
- Including mounting accessories
- Optionally with factory-installed seat heating (see page 50)

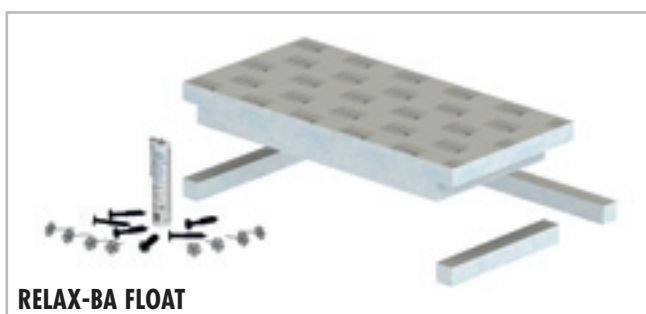

RELAX-BA FLOAT



■ PRODUCT SPECIFICATIONS – LUX ELEMENTS®-RELAX-BA

Packaging specifications see p. 140

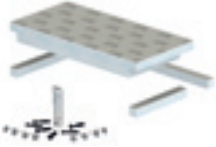
	ARTICLE-NUMBER	ARTICLE-NAME / ARTICLE-DESCRIPTION	NOMINAL FORMATS/DIMENSIONS LENGTH x WIDTH x HEIGHT	UNIT	PRICE / UNIT €
<b>Bench form CORNER FLOAT</b>					
	<b>LREL8001</b>	<b>RELAX-BA-CO FLOAT S</b> , bench form CORNER FLOAT S, floating, including mounting kit consisting of: 6 pieces FIX-SB 80S35, 4 pieces FIX-SD 80, 1 cartridge COL-MK	610 x 430 x 100 mm	piece	85,59
	<b>LREL8002</b>	<b>RELAX-BA-CO FLOAT L</b> , bench form CORNER FLOAT L, floating, including mounting kit consisting of: 6 pieces FIX-SB 80S35, 4 pieces FIX-SD 80, 1 cartridge COL-MK	849 x 600 x 100 mm	piece	116,35
<b>Bench form FLOAT</b>					
	<b>LREL8509</b>	<b>RELAX-BA FLOAT 800</b> , bench form FLOAT, floating, as building kit, including mounting kit consisting of: 8 pieces FIX-SB 80S35, 6 pieces FIX-SD 80, 1 cartridge COL-MK	800 x 450 x 100 mm	set	141,27
	<b>LREL8510</b>	<b>RELAX-BA FLOAT 900</b> , bench form FLOAT, floating, as building kit, including mounting kit consisting of: 8 pieces FIX-SB 80S35, 6 pieces FIX-SD 80, 1 cartridge COL-MK	900 x 450 x 100 mm	set	143,52
	<b>LREL8511</b>	<b>RELAX-BA FLOAT 1000</b> , bench form FLOAT, floating, as building kit, including mounting kit consisting of: 8 pieces FIX-SB 80S35, 6 pieces FIX-SD 80, 1 cartridge COL-MK	1000 x 450 x 100 mm	set	171,67



LUX ELEMENTS manufactures individual customised and special products for RELAX.

These include dimensions, thicknesses, shapes etc. that deviate from the standard programme. For more information see page 5.



Visit [www.luxelements.com](http://www.luxelements.com) for further information on RELAX.

Data sheets, assembly instructions, test certificates and additional brochures under 'Downloads', videos under 'Practice' and on YouTube.

## Backrests

### RELAX-BA-L

- Backrest, 2-piece, in two design variants:
  - with rounded surface: RELAX-BA-L R
  - with level surface: RELAX-BA-L E
- To suit the bench form SOLO, SHAPE and SIZE (see page 46)

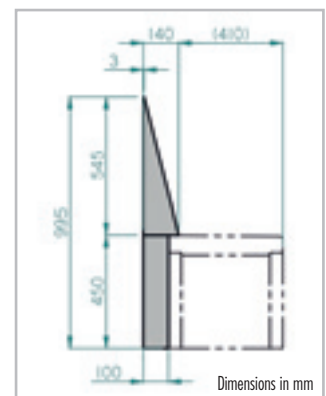
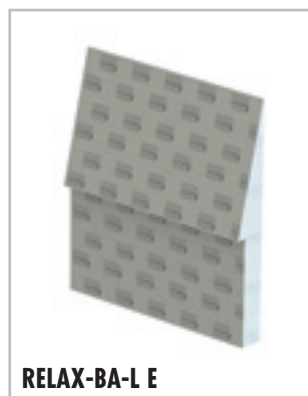
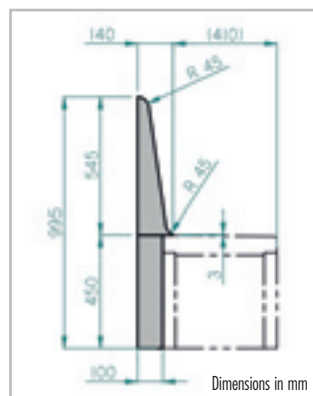
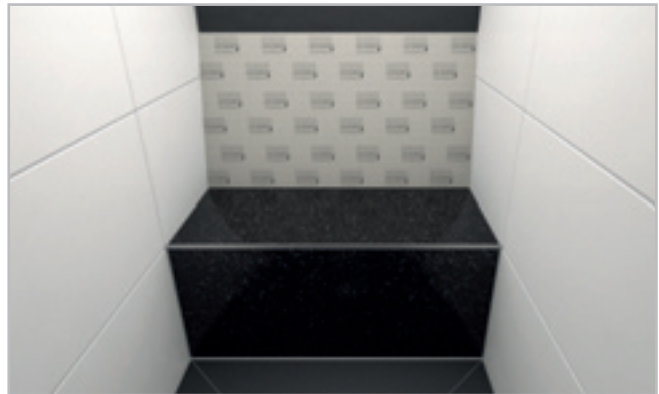

## Heating

### RELAX-BA HE-E / HE-E L

- Seat heating RELAX-BA HE-E, factory-installed heating for bench form SOLO, SHAPE, SIZE and FLOAT, incl. electronic temperature controller with time control (not suitable for damp rooms, protection class IP 30)
- Backrest heating RELAX-BA HE-E L, factory-installed heating for backrest BA-L R and BA-L E

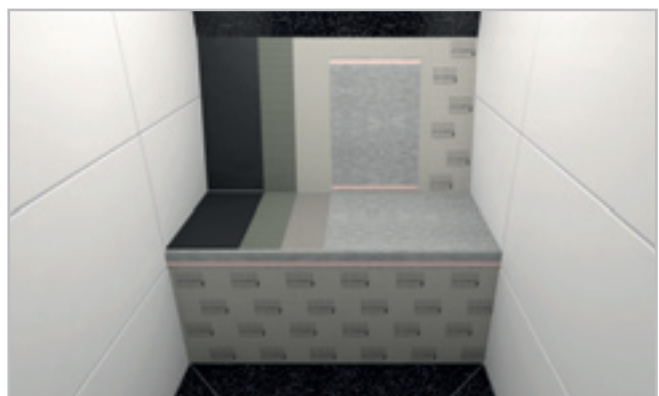

## Light

### RELAX-BA-LI L-WW

- LED light rope, warm white
- To suit the bench form SHAPE and SIZE
- 24 V, protection class IP 67
- Including power supply unit



■ PRODUCT SPECIFICATIONS – LUX ELEMENTS®-RELAX-BA

Packaging specifications see p. 140

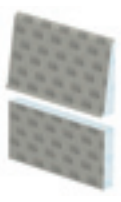
	ARTICLE-NUMBER	ARTICLE-NAME / ARTICLE-DESCRIPTION	NOMINAL FORMATS/DIMENSIONS LENGTH x WIDTH x HEIGHT	UNIT	PRICE / UNIT €
<b>Backrests</b>					
	LREL8550	<b>RELAX-BA-L R 800</b> , backrest, 2-piece, with rounded surface, 800 mm long, to suit the bench form SOLO, SHAPE and SIZE	800 x 450 x 100 mm, 800 x 545 x 140 mm	set	171,72
	LREL8551	<b>RELAX-BA-L R 900</b> , backrest, 2-piece, with rounded surface, 900 mm long, to suit the bench form SOLO, SHAPE and SIZE	900 x 450 x 100 mm, 900 x 545 x 140 mm	set	205,33
	LREL8552	<b>RELAX-BA-L R 1000</b> , backrest, 2-piece, with rounded surface, 1000 mm long, to suit the bench form SOLO, SHAPE and SIZE	1000 x 450 x 100 mm, 1000 x 545 x 140 mm	set	216,61
	LREL8553	<b>RELAX-BA-L E 800</b> , backrest, 2-piece, with level surface, 800 mm long, to suit the bench form SOLO, SHAPE and SIZE	800 x 450 x 100 mm, 800 x 545 x 140 mm	set	171,72
	LREL8554	<b>RELAX-BA-L E 900</b> , backrest, 2-piece, with level surface, 900 mm long, to suit the bench form SOLO, SHAPE and SIZE	900 x 450 x 100 mm, 900 x 545 x 140 mm	set	205,33
	LREL8555	<b>RELAX-BA-L E 1000</b> , backrest, 2-piece, with level surface, 1000 mm long, to suit the bench form SOLO, SHAPE and SIZE	1000 x 450 x 100 mm, 1000 x 545 x 140 mm	set	216,61
<b>Heating</b>					
	LREL8580	<b>RELAX-BA HE-E</b> , seat heating, factory-installed heating mat (162 W/m <sup>2</sup> , 36 V) with temperature sensor, for bench form SOLO, SHAPE, SIZE and FLOAT, incl. electronic temperature controller with time control (12 A, 230 V AC) for electric heating set, incl. transformer		surcharge	892,50
	LREL8581	<b>RELAX-BA HE-E L</b> , backrest heating, factory-installed heating mat (162 W/m <sup>2</sup> , 36 V), for backrest RELAX-BA-L R and E		surcharge	253,98
<b>Light</b>					
	LREL8590	<b>RELAX-BA-LI L-WW 800</b> , LED light rope warm white, preassembled to suit the bench form SHAPE and SIZE, length 800 mm, protection class IP 67, 24 V, 5 m supply cable, incl. power supply unit		set	205,02
	LREL8591	<b>RELAX-BA-LI L-WW 900</b> , LED light rope warm white, preassembled to suit the bench form SHAPE and SIZE, length 900 mm, protection class IP 67, 24 V, 5 m supply cable, incl. power supply unit		set	212,27
	LREL8592	<b>RELAX-BA-LI L-WW 1000</b> , LED light rope warm white, preassembled to suit the bench form SHAPE and SIZE, length 1000 mm, protection class IP 67, 24 V, 5 m supply cable, incl. power supply unit		set	234,09



LUX ELEMENTS manufactures individual customised and special products for RELAX.

These include dimensions, thicknesses, shapes etc. that deviate from the standard programme. For more information see page 5.



Visit [www.luxelements.com](http://www.luxelements.com) for further information on RELAX.

Data sheets, assembly instructions, test certificates and additional brochures under 'Downloads', videos under 'Practice' and on YouTube.

**Benches**

**RELAX-BA CUT**

- Prefabricated benches for bathroom, wellness and shower areas as a kit
- Two design variants:
  - rounded **RELAX-BA CUT-R**
  - angular **RELAX-BA CUT-E**
- Two assembly variants: with and without overhang for light strip
- Easy to cut to adapt to the space situation
- Optionally with backrest in two design variants (see page 54)
- Optionally with factory-installed seat heating or light (see LUX ELEMENTS Programme ‘Systems for wellness’)

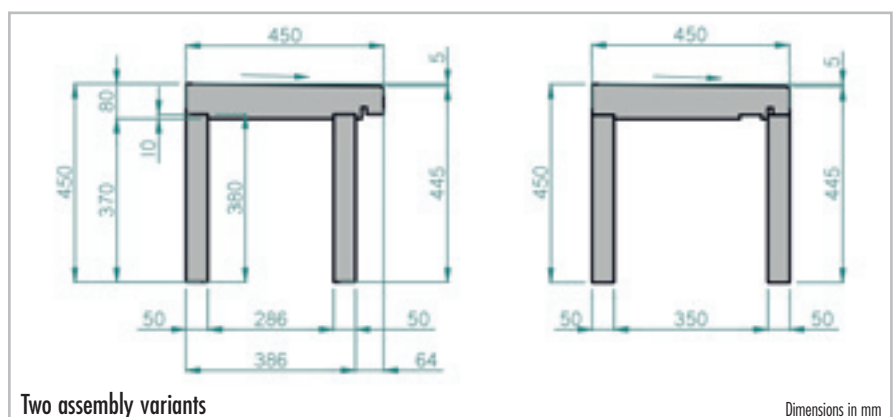
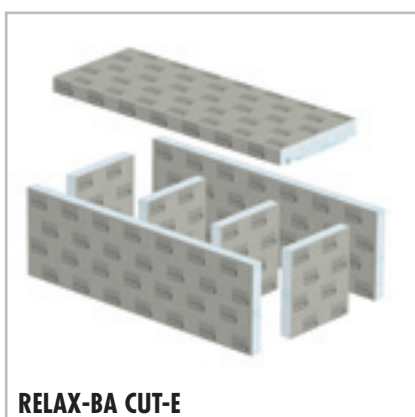
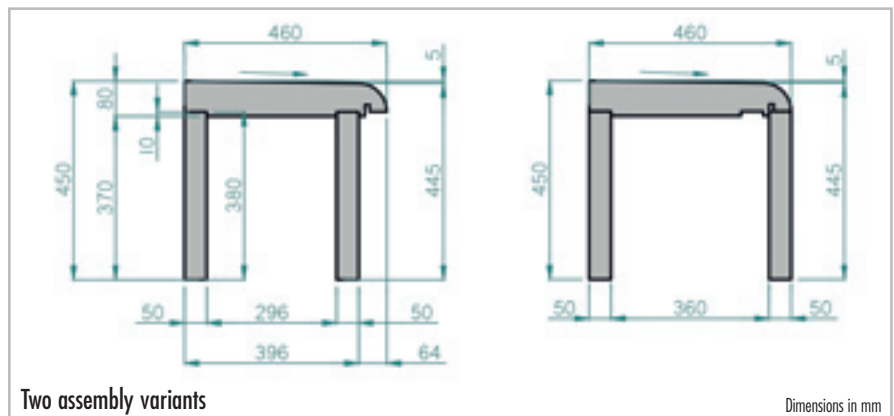
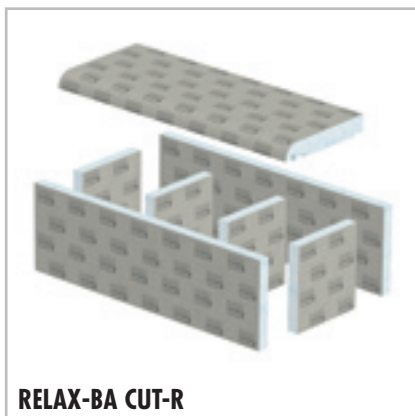
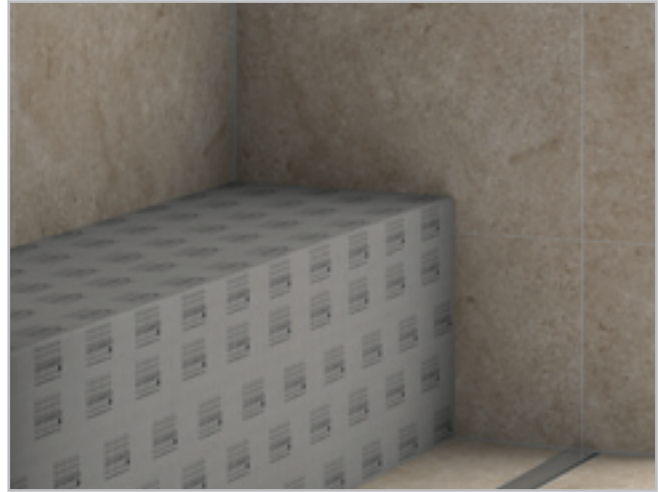

■ **PRODUCT SPECIFICATIONS – LUX ELEMENTS®-RELAX-BA**

Packaging specifications see p. 140

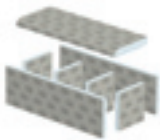
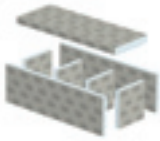
	ARTICLE-NUMBER	ARTICLE-NAME / ARTICLE-DESCRIPTION	NOMINAL FORMATS/DIMENSIONS LENGTH x WIDTH x HEIGHT	UNIT	PRICE / UNIT €
	<b>LREL8512</b>	<b>RELAX-BA CUT-R 1200</b> , bench form CUT-R, straight, 1200 mm long, as building kit	1200 x 460 x 450 mm	set	430,24
	<b>LREL8513</b>	<b>RELAX-BA CUT-E 1200</b> , bench form CUT-E, straight, 1200 mm long, as building kit	1200 x 450 x 450 mm	set	430,24



LUX ELEMENTS manufactures individual customised and special products for RELAX.

These include dimensions, thicknesses, shapes etc. that deviate from the standard programme. For more information see page 5.



Visit [www.luxelements.com](http://www.luxelements.com) for further information on RELAX.

Data sheets, assembly instructions, test certificates and additional brochures under 'Downloads', videos under 'Practice' and on YouTube.

## Backrests

### RELAX-BA-L

- Backrest, 2-piece, in two design variants:
  - with rounded surface: **RELAX-BA-L R**
  - with level surface: **RELAX-BA-L E**
- To suit the bench form **CUT** (see page 52)
- Optional including factory-fitted electric heating (thermostatic controllers in different versions see LUX ELEMENTS Programme 'Systems for wellness')



RELAX-BA-L R 1200



RELAX-BA-L E 1200

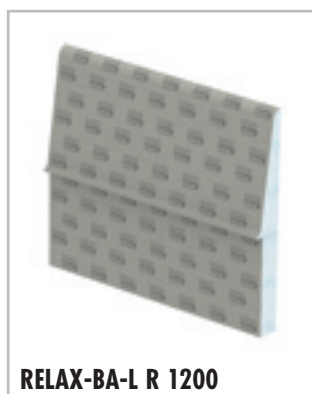

RELAX-BA-L R 1200

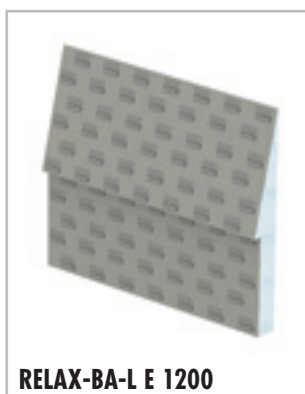
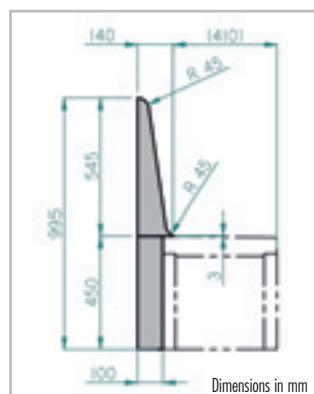

RELAX-BA-L E 1200

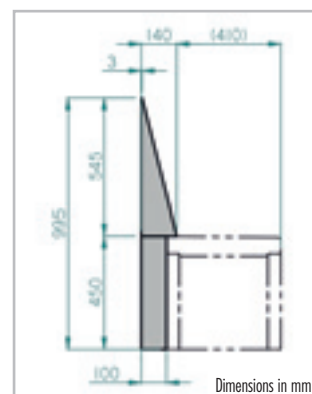

■ **PRODUCT SPECIFICATIONS – LUX ELEMENTS®-RELAX-BA**

Packaging specifications see p. 140

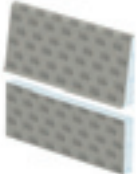
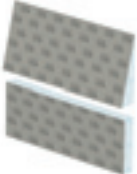
	ARTICLE-NUMBER	ARTICLE-NAME / ARTICLE-DESCRIPTION	NOMINAL FORMATS/DIMENSIONS LENGTH x WIDTH x HEIGHT	UNIT	PRICE / UNIT €
	<b>LREL8556</b>	<b>RELAX-BA-L R 1200</b> , backrest, 2-piece, with rounded surface, 1200 mm long, to suit the bench form CUT	1200 x 450 x 100 mm 1200 x 545 x 140 mm	set	236,34
	<b>LREL8557</b>	<b>RELAX-BA-L E 1200</b> , backrest, 2-piece, with level surface, 1200 mm long, to suit the bench form CUT	1200 x 450 x 100 mm 1200 x 545 x 140 mm	set	236,34



LUX ELEMENTS manufactures individual customised and special products for RELAX.

These include dimensions, thicknesses, shapes etc. that deviate from the standard programme. For more information see page 5.



Visit [www.luxelements.com](http://www.luxelements.com) for further information on RELAX.

Data sheets, assembly instructions, test certificates and additional brochures under 'Downloads', videos under 'Practice' and on YouTube.



## Shower partition walls

### RELAX-TW

- Prefabricated shower partition wall elements in two sizes:
  - TW 900: 2500 mm high, 900 mm wide
  - TW 1200: 2500 mm high, 1200 mm wide
- Individual niche milling possible
- Optional including factory-fitted electric heating (thermostatic controllers in different versions see LUX ELEMENTS Programme 'Systems for wellness')

### Hard plastic insert – FIX PRO-MAK



- For adhering to hard foam, for the stable fastening, for example, of hose holders or fittings
- Product specifications see page 20





### ■ PRODUCT SPECIFICATIONS – LUX ELEMENTS®-RELAX-TW

Packaging specifications see p. 141 · \* standard-compliant according to DIN 18534

	ARTICLE-NUMBER	ARTICLE-NAME / ARTICLE-DESCRIPTION	NOMINAL FORMATS/DIMENSIONS HEIGHT x WIDTH x THICKNESS	UNIT	PRICE / UNIT €
	<b>LREL9000</b>	<b>RELAX-TW 900*</b> , shower partition wall element, prefabricated from hard foam support material	2500 x 900 x 100 mm	piece	447,13
	<b>LREL9001</b>	<b>RELAX-TW 1200*</b> , shower partition wall element, prefabricated from hard foam support material	2500 x 1200 x 100 mm	piece	581,81
	<b>LREL9002</b>	<b>RELAX-TW NI</b> , individual niche milling (90 mm deep) in RELAX-TW 900 or 1200 (max. dimensions: 1200 x 540 mm)	made to measure	piece	127,97
	<b>LREL9003</b>	<b>RELAX-TW EH</b> , electric heating for RELAX-TW, factory-fitted heating mat (280 W/m <sup>2</sup> , 230 V) incl. temperature sensor, individually made to measure as surcharge		set	on request
	<b>LREL9011</b>	<b>RELAX-TW LI-WW</b> , LED light rope warm white, protection class IP 67, 24 V, 5 m supply cable, for RELAX-TW NI (made to measure), incl. power supply unit	max. length 500 mm	set	186,94



LUX ELEMENTS manufactures individual customised and special products for RELAX.

These include dimensions, thicknesses, shapes etc. that deviate from the standard programme. For more information see page 5.



Visit [www.luxelements.com](http://www.luxelements.com) for further information on RELAX and DECO.

Data sheets, assembly instructions, test certificates and additional brochures under 'Downloads', videos under 'Practice' and on YouTube.

# LUX ELEMENTS – Systems for bathroom and shower

## Showers

Here you will find an extensive range of systems for the manufacture of flush with the floor showers on unfinished floors or in wooden sub-constructions, plus drainage technology and accessories. Depending on the installation situation, the products for unfinished floors are divided into "in screed", "shower bases with integrated drainage technology" and "shower bases with separate drainage technology".

See page 60/61 for more information and overview of the standard products.



ETA-13/0238  
LUX ELEMENTS®  
WATERTIGHT SOLUTION  
COMPONENT 3.2/8  
www.luxelements.com  
0799-CPR-130 - Nr LEWS2013



# Showers – Content



## Systems on unfinished floors – in screed

<b>General information</b> .....	62–63
<b>Overview of standard formats</b> .....	64–65
<b>Point drainage</b>	
Shower drain element, drainage technology integrated – TUB-COMBI MQ SET 300 .....	66
Shower drain element, drainage technology separate – TUB-MQ-SET 300 .....	66
<b>Linear drainage</b>	
Floor channel drains, drainage technology integrated – TUB-LINE COMBI RT .....	68
Floor channel drains, drainage technology integrated, with extended cover rail – TUB-LINE COMBI V RT .....	70
Floor channel drains, drainage technology separate – TUB-LINE RT, gradient and substrate elements .....	72
Floor channel drains, drainage technology separate, with extended cover rail – TUB-LINE V RT, gradient and substrate elements .....	74



## Systems on unfinished floors – integrated drainage technology

<b>General information</b> .....	76–77
<b>Overview of standard formats</b> .....	78–79
<b>Point drainage</b>	
Flush with the floor extra-slim shower bases, drainage technology integrated – TUB-COMBI-S .....	80
Flush with the floor extra-slim shower bases for the substitution of bath tubs, drainage technology integrated – TUB-COMBI-S BOL .....	82
Flush with the floor shower bases with integrated floor drain pump – TUB-PUMP .....	84
<b>Linear drainage</b>	
Flush with the floor extra-slim shower bases, drainage technology integrated – TUB-LINE COMBI .....	86



## Systems on unfinished floors – separate drainage technology

<b>General information</b> .....	88–89
<b>Overview of standard formats</b> .....	90–91
<b>Point drainage</b>	
Flush with the floor shower bases, drainage technology separate – TUB-EQ/-MQ/-ER/-MR .....	92
Flush with the floor shower bases for the substitution of bath tubs, drainage technology separate – TUB-BOL .....	96
Flush with the floor shower bases, drainage technology separate, including surface element – TUB-FINISH .....	98
<b>Linear drainage</b>	
Flush with the floor shower bases, drainage technology separate, TUB-LINE .....	100
Flush with the floor shower bases for the substitution of bath tubs, drainage technology separate – TUB-LINE BOL .....	106
Flush with the floor shower bases, drainage technology separate, with extended cover rail – TUB-LINE V .....	108
Flush with the floor shower bases for the substitution of bath tubs, drainage technology separate, with extended cover rail – TUB-LINE BOL V ...	110
Flush with the floor shower bases, drainage technology separate, including surface element – TUB-LINE FINISH .....	112
<b>Substrate elements</b> for TUB and TUB-LINE – TUB-U .....	114



## Systems in wooden sub-constructions

<b>General information</b> .....	116–117
<b>Overview of standard formats</b> .....	118–119
<b>Point drainage</b>	
Flush with the floor shower bases, drainage technology separate, for installation in wooden sub-constructions – TUB-H .....	120
Flush with the floor shower bases for the substitution of bath tubs, drainage technology separate, for installation in wooden sub-constructions – TUB-H BOL .....	124
<b>Linear drainage</b>	
Flush with the floor shower bases, drainage technology separate, for installation in wooden sub-constructions – TUB-LINE H .....	126
Flush with the floor shower bases for the substitution of bath tubs, drainage technology separate, for installation in wooden sub-constructions – TUB-LINE H BOL .....	128



## Drainage technology and accessories

Floor drain supports and accessories TUB .....	130
Floor drain supports and accessories TUB-LINE .....	134
Mounting accessories for TUB and TUB-LINE – TUB-KIT .....	136

## Overview according to installation situations

### ■ Systems on unfinished floors – in screed

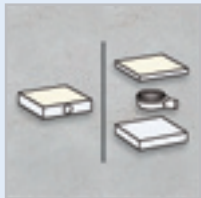

... drainage technology integrated or separate

from page 62

### ■ Systems on unfinished floors – integrated drainage technology



... including special solution for missing gravity flow

from page 76

### ■ Systems on unfinished floors – separate drainage technology



... including special solution for jointless surface

from page 88

### ■ Systems in wooden sub-constructions – separate drainage technology



from page 116

### ■ Drainage technology and accessories



... for all systems

from page 130

**Shower drain element with point drainage**

LUX ELEMENTS®-TUB-MQ-SET ... / LUX ELEMENTS®-TUB-COMBI MQ SET ...

**Floor channel drains with linear drainage and gradient and substrate elements**

LUX ELEMENTS®-TUB-LINE (V) RT ... / LUX ELEMENTS®-TUB-LINE COMBI (V) RT ... / LUX ELEMENTS®-TUB-LINE (COMBI) GK ...

**Shower bases with point drainage**

LUX ELEMENTS®-TUB-COMBI ... / LUX ELEMENTS®-TUB-PUMP ...

**Shower bases with linear drainage**

LUX ELEMENTS®-TUB-LINE COMBI ...

**Shower bases with point drainage**

LUX ELEMENTS®-TUB ... / LUX ELEMENTS®-TUB-FINISH ...

**Shower bases with linear drainage**

LUX ELEMENTS®-TUB-LINE ... / LUX ELEMENTS®-TUB-LINE FINISH ...

**Substrate elements**

LUX ELEMENTS®-TUB-U

**Shower bases with point drainage**

LUX ELEMENTS®-TUB-H ...

**Shower bases with linear drainage**

LUX ELEMENTS®-TUB-LINE H ...

**Drainage technology and accessories for point drainage**

LUX ELEMENTS®-TUB ...

**Drainage technology and accessories for linear drainage**

LUX ELEMENTS®-TUB-LINE ...

**Mounting accessories**

LUX ELEMENTS®-TUB-KIT ...

## ■ Systems on unfinished floors – in screed

**LUX ELEMENTS® shower drain elements** (point drainage) and **floor channel drains** (linear drainage) with integrated or separate drainage technology for installation on unfinished floors, in screed – ready for tiling!

### ■ General properties

	TUB-COMBI(-S) MQ SET 300	TUB-MQ-SET 300	TUB-LINE COMBI ... RT	TUB-LINE ... RT
For barrier-free construction	■	■	■	■
Height-adjustable drain system	page 130	page 130	page 63	page 63
Grate fitting frame, factory-fitted	■	■	–	–
Floor channel drain, factory-fitted	–	–	■	■
Integrated drainage technology	■	–	■	–
Separate drainage technology	–	■	–	■
Loose sealing sleeve, compliant with DIN 18534	■	■	■	■
Second drainage level	■	■	■	■
Click system for fastening the drain connection fitting	–	■	–	■
Matching mounting accessories	from page 136	from page 136	from page 136	from page 136

### ■ Installation principle, integrated drainage technology

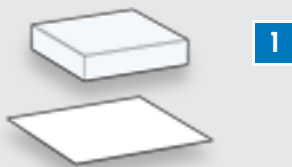

- 1** Combination of **shower drain element** or **floor channel drain** and **horizontal floor drain support** (DN 40 or DN 50), square or rectangular depending on drainage method (point or linear drainage)  
- Details point drainage + linear drainage: page 63

### ■ Installation principle, separate drainage technology

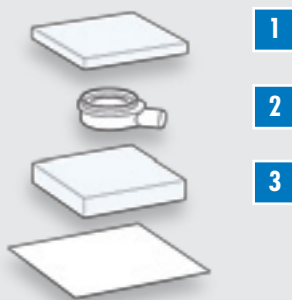

- 1** **Shower drain element** or **floor channel drain** – depending on drainage method (point or linear drainage), square or rectangular, integrated floor drain system with separate drainage technology  
- Details point drainage + linear drainage: page 63
- 2** **Drain support** – vertical (DN 40 or DN 50) or horizontal (DN 50) freely selectable depending on requirements; simple, fast and safe mounting by means of click system without gluing or screwing  
- Details: from page 130 (point drainage)  
- Details: page 134 (linear drainage)
- 3** **Substrate element** – for optimal height adjustment depending on the installation situation

### ■ Installation heights

Dimensions in mm. Measures without adhesive coating and tiles.

#### Integrated drainage technology

TUB-COMBI(-S) MQ SET 300

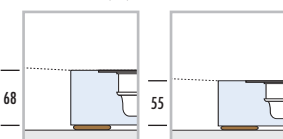

TUB-LINE COMBI (V) RT ...

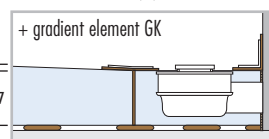

#### Separate drainage technology

TUB-MQ-SET 300

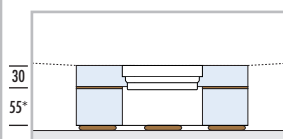

TUB-LINE (V) RT ...

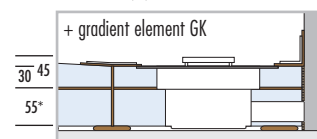

\* substrate element used depending on the installation situation

■ Properties, point drainage

**Grates/grate fitting frames** – compatible with all LUX ELEMENTS®-TUB-RA... variants, standard and design – see page 131

**Design variants** – basic shape: square, drain position: centre



**TUB-COMBI MQ SET 300**



**TUB-COMBI-S MQ SET 300**



**TUB-MQ-SET 300**

■ Properties, linear drainage

**Cover rail / Floor channel drain** – dimensions: 70 x 650 mm, 70 x 750 mm or 70 x 850 mm, depending on the size of the hard foam support element

**Special features:** reversible cover rail for two design variants (brushed stainless steel and tileable rear side), tiling aid for clean tiling, height adjustable from 5 – 17 mm using height adapter, with odour trap



**Design variants** – basic shape: rectangular



**TUB-LINE RT 900/200 (650)**



**TUB-LINE RT 900/200 (750)**



**TUB-LINE RT 1200/200 (850)**



**TUB-LINE COMBI RT 900 (650)**



**TUB-LINE COMBI RT 900 (750)**



**TUB-LINE COMBI RT 1200 (850)**

**Extended cover rail V** – dimensions: 70 x 1000 / 1200 / 1800 mm depending on the size of the hard foam support element

**Special features:** brushed stainless steel (non-reversible), can be shortened (Including accessories for the stepless adaptation of the stainless steel components), tiling aid for clean tiling, height adjustable from 5 – 17 mm using height adapter, with odour trap



**Design variants** – basic shape: rectangular

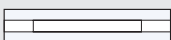

**TUB-LINE V RT 1000/200 (650)**

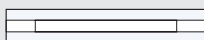

**TUB-LINE V RT 1200/200 (850)**

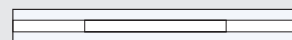

**TUB-LINE V RT 1800/200 (850)**

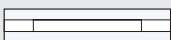

**TUB-LINE COMBI V RT 1000 (650)**

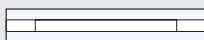

**TUB-LINE COMBI V RT 1200 (850)**

OVERVIEW STANDARD FORMATS / SHOWER DRAIN ELEMENTS

		SIDE LENGTH
		300 mm
SIDE LENGTH	300 mm	<p>TUB-COMBI MQ SET (p. 67)                      TUB-COMBI-S MQ SET (p. 67)                      TUB-MQ-SET (p. 67)</p>

OVERVIEW STANDARD FORMATS / FLOOR CHANNEL DRAINS

		SIDE LENGTH – SHORT SIDE
		200 mm
SIDE LENGTH – LONG SIDE	800 mm	<p>TUB-LINE COMBI V RT 800 (650) (p. 72)                      TUB-LINE V RT 800/200 (650) (p. 76)</p>
	900 mm	<p>TUB-LINE COMBI RT 900 (650) (p. 69)                      TUB-LINE COMBI RT 900 (750) (p. 69)                      TUB-LINE COMBI V RT 900 (650) (p. 72)</p> <p>TUB-LINE RT 900/200 (650) (p. 73)                      TUB-LINE RT 900/200 (750) (p. 73)                      TUB-LINE V RT 900/200 (650) (p. 76)</p>
	1000 mm	<p>TUB-LINE COMBI V RT 1000 (650) (p. 71)                      TUB-LINE V RT 1000/200 (650) (p. 75)</p>
	1100 mm	<p>TUB-LINE COMBI V RT 1100 (650) (p. 72)                      TUB-LINE V RT 1100/200 (650) (p. 76)</p>
	1200 mm	<p>TUB-LINE COMBI RT 1200 (p. 69)                      TUB-LINE COMBI V RT 1200 (850) (p. 71)                      TUB-LINE RT 1200/200 (850) (p. 73)                      TUB-LINE V RT 1200/200 (850) (p. 75)</p>
	1800 mm	<p>TUB-LINE COMBI V RT 1800 (850) (p. 72)                      TUB-LINE V RT 1800/200 (850) (p. 75)</p>



OVERVIEW STANDARD FORMATS / GRADIENT ELEMENTS + SUBSTRATE ELEMENTS

		SIDE LENGTH – SHORT SIDE				
		800 mm	900 mm	1000 mm	1100 mm	1200 mm
SIDE LENGTH – LONG SIDE	800 mm	TUB-LINE COMBI GK Q1 (p. 71) TUB-LINE GK Q1 (p. 75) TUB-UQ (p. 75)				
	900 mm		TUB-LINE COMBI GK Q1 (p. 71) TUB-LINE GK Q1 (p. 75) TUB-UQ (p. 75)			
	1000 mm			TUB-LINE COMBI GK Q1 (p. 69/71) TUB-LINE GK Q1 (p. 73/75) TUB-UQ (p. 75)		
	1100 mm				TUB-LINE COMBI GK Q1 (p. 71) TUB-LINE GK Q1 (p. 75) TUB-UQ (p. 75)	
	1200 mm		TUB-LINE COMBI GK R1 (p. 69) TUB-LINE GK R1 (p. 73) TUB-UR (p. 73)			TUB-LINE COMBI GK Q1 (p. 69/71) TUB-LINE GK Q1 (p. 73/75) TUB-UQ (p. 73/75)
	1800 mm			TUB-LINE COMBI GK R1 (p. 71) TUB-LINE GK R1 (p. 75) TUB-UBOL (p. 75)		

Hard foam shower drain element with integrated drainage technology

**TUB-COMBI MQ SET 300 / TUB-COMBI-S MQ SET 300**

- For the installation in screed floors with slope
- Combination of shower drain element and horizontal floor drain support
- Including loose sealing sleeve
- Extra-flat shower base height
- For barrier-free construction
- Second drainage level
- Drainage capacity (higher than required by standard):
  - TUB-COMBI MQ SET 300: 1,0 l/s
  - TUB-COMBI-S MQ SET 300: 0,8 l/s
- Large selection of grate fitting frames (incl. standard or design grate)



■ Shower drain element with integrated drainage technology

TUB-COMBI MQ SET 300

TUB-COMBI-S MQ SET 300

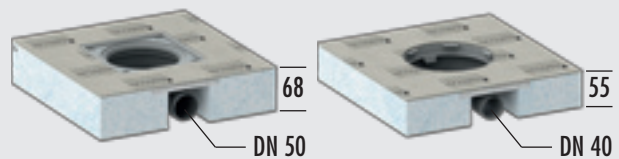

Dimensions in mm

Hard foam shower drain element with separate drainage technology

**TUB-MQ-SET 300**

- For the installation in screed floors with slope
- Integrated floor drain support frame
- Including loose sealing sleeve
- Including substrate element for height adjustment
- For barrier-free construction
- Second drainage level
- Drainage technology separate, thus universally usable (from page 130)

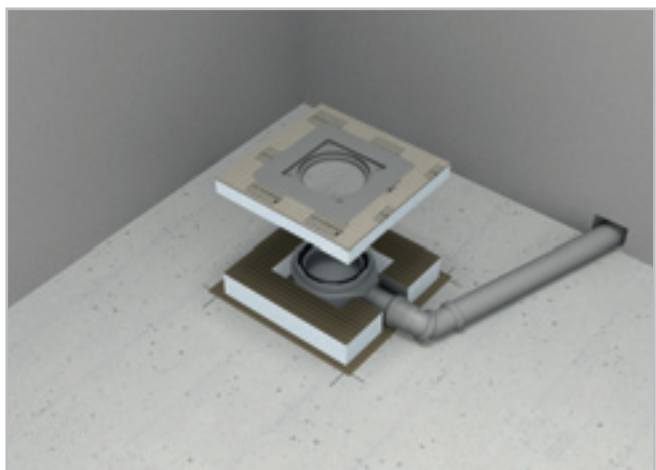

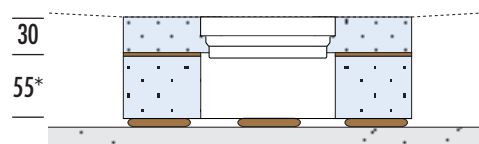

■ Installation height TUB-MQ-SET 300

\* substrate element used depending on the installation situation



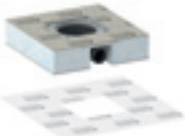

Please note: Dimensions in mm. Measures without adhesive coating and tiles.

■ **PRODUCT SPECIFICATIONS – LUX ELEMENTS®-TUB-COMBI(-S) MQ SET 300** Packaging specifications see p. 141 · Online calculator see p. 7 · \* standard-compliant according to DIN 18534

ARTICLE-NUMBER	ARTICLE-NAME / ARTICLE-DESCRIPTION	NOMINAL FORMATS/DIMENSIONS LENGTH x WIDTH x HEIGHT	UNIT	PRICE / UNIT €
				
<b>TUB-COMBI MQ SET 300</b>		<b>TUB-COMBI-S MQ SET 300</b>		
	<b>LTUBE19003</b> <b>TUB-COMBI MQ SET 300*</b> , extra-slim hard foam shower drain element with integrated horizontal floor drain <b>DN 50</b> , with odour trap, incl. loose sealing sleeve 400 x 400 mm, drain in the centre → <b>Accessories see page 133</b>	300 x 300 x 68 mm	set	160,48
	<b>LTUBE19325</b> <b>TUB-COMBI-S MQ SET 300*</b> , extra-slim hard foam shower drain element with integrated horizontal floor drain <b>DN 40</b> , with odour trap, incl. loose sealing sleeve 400 x 400 mm, drain in the centre → <b>Accessories see page 133</b>	300 x 300 x 55 mm	set	160,47

 LUX ELEMENTS manufactures individual customised and special products for TUB. These include dimensions, thicknesses, shapes etc. that deviate from the standard programme. For more information see page 5.

■ **PRODUCT SPECIFICATIONS – LUX ELEMENTS®-TUB-MQ-SET 300** Packaging specifications see p. 141 · Online calculator see p. 7 · \* standard-compliant according to DIN 18534

ARTICLE-NUMBER	ARTICLE-NAME / ARTICLE-DESCRIPTION	NOMINAL FORMATS/DIMENSIONS LENGTH x WIDTH x HEIGHT	UNIT	PRICE / UNIT €
				
<b>TUB-MQ-SET 300</b>				
	<b>LTUBE1111</b> <b>TUB-MQ-SET 300*</b> , hard foam shower drain element with integrated floor drain support frame 135 x 135 mm, loose sealing sleeve 400 x 400 mm and substrate element TUB-UMQ 300 x 300 x 55 mm → <b>Drainage technology and accessories see page 130–133</b>	300 x 300 x 30 mm	set	86,86

 LUX ELEMENTS manufactures individual customised and special products for TUB. These include dimensions, thicknesses, shapes etc. that deviate from the standard programme. For more information see page 5.

 Visit [www.luxelements.com](http://www.luxelements.com) for further information on TUB. Data sheets, assembly instructions, test certificates and additional brochures under 'Downloads', videos under 'Practice' and on YouTube.



## Floor channel drain with integrated drainage technology

### TUB-LINE COMBI RT

- Combination of floor channel drain (70 x 650 mm, 70 x 750 mm or 70 x 850 mm) integrated in hard foam support element and horizontal drain support, including sealing sleeve
- Extra-flat height RT: 67 mm
- Reversible channel cover rail offers two design options
- Clean tiling with tiling aid
- Height-adjustable for optimum adaptation to covering thickness
- For barrier-free construction
- Second drainage level
- Drainage capacity: 0,52 l/s
- Also available with extended cover rail, see page 70

### Gradient elements for TUB-LINE COMBI RT

### TUB-LINE COMBI GK

- Can be fixed on one or both sides
- Simple cutting to length on the higher side for adaptation to the room situation
- Factory sealing and prefabricated gradient



#### ■ Combination possibilities



#### ■ Installation height

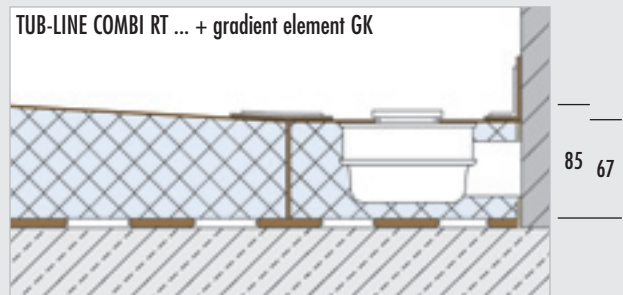

**Please note:** Dimensions in mm. Measures without adhesive coating and tiles.

■ **PRODUCT SPECIFICATIONS – LUX ELEMENTS®-TUB-LINE COMBI RT / GK** Packaging specifications see p. 141 · Online calculator see p. 7 · \* standard-compliant according to DIN 18534

ARTICLE-NUMBER	ARTICLE-NAME / ARTICLE-DESCRIPTION	NOMINAL FORMATS/DIMENSIONS LENGTH x WIDTH x HEIGHT	UNIT	PRICE / UNIT €
----------------	------------------------------------	--	------	----------------

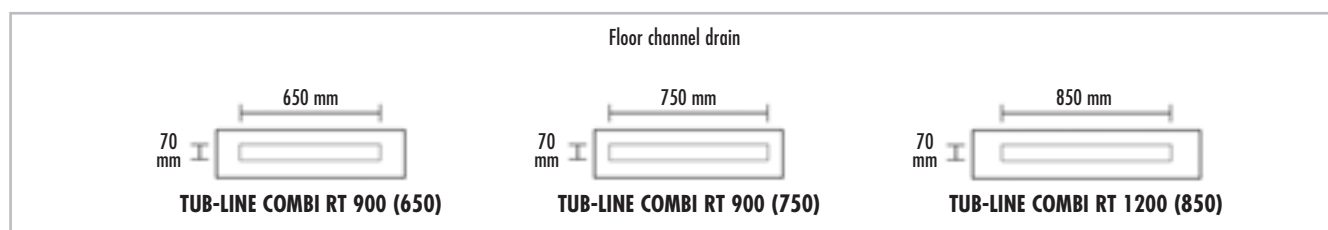

	<b>TUB-LINE COMBI RT</b> , floor channel drain with integrated horizontal drain support, with cover rail and tiling aid made of brushed stainless steel, cover rail tileable on the rear side, with odour trap, height adjustable with height adapter from 5–17 mm, integrated in hard foam support element, including sealing sleeve. → <b>Accessories see page 134</b>				
	<b>LTUBE9316</b>	<b>TUB-LINE COMBI RT 900 (650)*</b> , floor channel drain 70 x 650 mm, with integrated horizontal drain support, integrated in hard foam support element, including sealing sleeve 1000 x 300 mm	200 x 900 x 67 mm	piece	499,83
	<b>LTUBE9306</b>	<b>TUB-LINE COMBI RT 900 (750)*</b> , floor channel drain 70 x 750 mm, with integrated horizontal drain support, integrated in hard foam support element, including sealing sleeve 1000 x 300 mm	200 x 900 x 67 mm	piece	520,47
	<b>LTUBE9307</b>	<b>TUB-LINE COMBI GK R1 1200/900*</b> , hard foam descending gradient element, sealed, with one-sided gradient	1200 x 900 x 70/85 mm	piece	259,37
	<b>LTUBE9308</b>	<b>TUB-LINE COMBI RT 1200 (850)*</b> , floor channel drain 70 x 850 mm, with integrated horizontal drain support, integrated in hard foam support element, including sealing sleeve 1300 x 300 mm	200 x 1200 x 67 mm	piece	548,86
	<b>LTUBE9309</b>	<b>TUB-LINE COMBI GK Q1 1200*</b> , hard foam descending gradient element, sealed, with one-sided gradient	1200 x 1200 x 70/85 mm	piece	326,15



LUX ELEMENTS manufactures individual customised and special products for TUB.

These include dimensions, thicknesses, shapes etc. that deviate from the standard programme. For more information see page 5.



Visit [www.luxelements.com](http://www.luxelements.com) for further information on TUB.

Data sheets, assembly instructions, test certificates and additional brochures under 'Downloads', videos under 'Practice' and on YouTube.



Floor channel drain with integrated drainage technology with extended cover rail

**TUB-LINE COMBI V RT**

- Combination of floor channel drain integrated in hard foam support element and horizontal drain support, including sealing sleeve
- With extended cover rail (non-reversible) and extended tiling aid made of brushed stainless steel for continuous wall-to-wall channel look
- Can be shortened to fit the shower area
- Extra-flat height RT: 67 mm
- Height-adjustable for optimum adaptation to covering thickness
- For barrier-free construction
- Second drainage level
- Drainage capacity: 0,52 l/s



Gradient elements for TUB-LINE COMBI V RT

**TUB-LINE COMBI GK**

- Can be fixed on one or both sides
- Simple cutting to length on the higher side for adaptation to the room situation
- Factory sealing and prefabricated gradient

■ Combination possibilities

■ Stepless adaptation

- for TUB-LINE COMBI V RT ... (650): up to 740 mm
- for TUB-LINE COMBI V RT ... (850): up to 940 mm

■ Installation height

TUB-LINE COMBI V RT ... + gradient element GK

**Please note:** Dimensions in mm. Measures without adhesive coating and tiles.

## SYSTEMS ON UNFINISHED FLOORS – SHOWERS LINEAR DRAINAGE / IN SCREED

■ **PRODUCT SPECIFICATIONS – LUX ELEMENTS®-TUB-LINE COMBI V RT / GK** Packaging specifications see p. 141 · Online calculator see p. 7 · \* standard-compliant according to DIN 18534

ARTICLE-NUMBER	ARTICLE-NAME / ARTICLE-DESCRIPTION	NOMINAL FORMATS/DIMENSIONS LENGTH x WIDTH x HEIGHT	UNIT	PRICE / UNIT €
----------------	------------------------------------	--	------	----------------

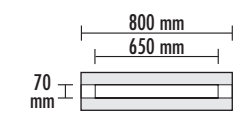
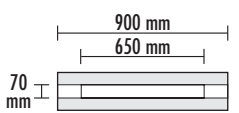
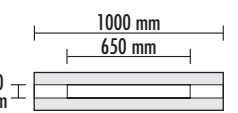
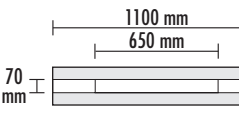
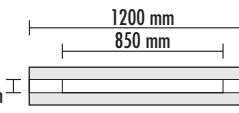
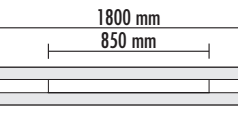
Floor channel drain				
				
<b>TUB-LINE COMBI V RT 800 (650)</b>	<b>TUB-LINE COMBI V RT 900 (650)</b>	<b>TUB-LINE COMBI V RT 1000 (650)</b>		
				
<b>TUB-LINE COMBI V RT 1100 (650)</b>	<b>TUB-LINE COMBI V RT 1200 (850)</b>	<b>TUB-LINE COMBI V RT 1800 (850)</b>		

<p><b>TUB-LINE COMBI V RT</b>, floor channel drain with integrated horizontal drain support, with extended tiling aid V and extended cover rail V in brushed stainless steel, with odour trap, height adjustable with height adapter from 5–17 mm, integrated in hard foam support element, including sealing sleeve. Including accessories for the stepless adaptation of the stainless steel components. → Accessories see page 134</p>					
	<b>LTUBE98303</b>	<b>TUB-LINE COMBI V RT 800 (650)*</b> , extended cover rail V, 800 mm long, including sealing sleeve 900 x 300 mm	200 x 800 x 67 mm	piece	593,64
	<b>LTUBE98304</b>	<b>TUB-LINE COMBI V RT 900 (650)*</b> , extended cover rail V, 900 mm long, including sealing sleeve 1000 x 300 mm	200 x 900 x 67 mm	piece	599,76
	<b>LTUBE98301</b>	<b>TUB-LINE COMBI V RT 1000 (650)*</b> , extended cover rail V, 1000 mm long, including sealing sleeve 1100 x 300 mm	200 x 1000 x 67 mm	piece	605,56
	<b>LTUBE98305</b>	<b>TUB-LINE COMBI V RT 1100 (650)*</b> , extended cover rail V, 1100 mm long, including sealing sleeve 1200 x 300 mm	200 x 1100 x 67 mm	piece	631,38
	<b>LTUBE98302</b>	<b>TUB-LINE COMBI V RT 1200 (850)*</b> , extended cover rail V, 1200 mm long, including sealing sleeve 1300 x 300 mm	200 x 1200 x 67 mm	piece	644,14
	<b>LTUBE98306</b>	<b>TUB-LINE COMBI V RT 1800 (850)*</b> , extended cover rail V, 1800 mm long, including sealing sleeve 1900 x 300 mm	200 x 1800 x 67 mm	piece	786,93
<b>TUB-LINE COMBI GK</b> , hard foam descending gradient element, sealed, with one-sided gradient					
	<b>LTUBE9345</b>	<b>TUB-LINE COMBI GK Q1 800*</b> , descending gradient element	800 x 800 x 70/85 mm	piece	216,86
	<b>LTUBE9346</b>	<b>TUB-LINE COMBI GK Q1 900*</b> , descending gradient element	900 x 900 x 70/85 mm	piece	249,90
	<b>LTUBE9305</b>	<b>TUB-LINE COMBI GK Q1 1000*</b> , descending gradient element	1000 x 1000 x 70/85 mm	piece	290,39
	<b>LTUBE9347</b>	<b>TUB-LINE COMBI GK Q1 1100*</b> , descending gradient element	1100 x 1100 x 70/85 mm	piece	314,67
	<b>LTUBE9309</b>	<b>TUB-LINE COMBI GK Q1 1200*</b> , descending gradient element	1200 x 1200 x 70/85 mm	piece	326,15
	<b>LTUBE9348</b>	<b>TUB-LINE COMBI GK R1 1000/1800*</b> , descending gradient element	1000 x 1800 x 70/85 mm	piece	455,94



LUX ELEMENTS manufactures individual customised and special products for TUB.

These include dimensions, thicknesses, shapes etc. that deviate from the standard programme. For more information see page 5.



## Floor channel drains with separate drainage technology

### TUB-LINE RT

- Floor channel drain (70 x 650 mm, 70 x 750 mm or 70 x 850 mm) integrated in hard foam support element, with sealing sleeve
- Height RT: 30 mm
- Reversible channel cover rail offers two design options
- Clean tiling with tiling aid
- Height-adjustable for optimum adaptation to covering thickness
- For barrier-free construction
- Second drainage level
- Including substrate element, Height: 55 mm
- Secure click system for fastening the drain connection fitting
- Suitable drain systems, see page 134
- Also available with extended cover rail, see page 74



### Gradient elements for TUB-LINE RT

### TUB-LINE GK

- Can be fixed on one or both sides
- Simple cutting to length on the higher side for adaptation to the room situation
- Factory sealing and prefabricated gradient
- Matching substrate elements with a height of 55 mm

#### ■ Combination possibilities

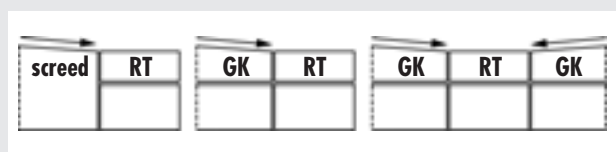

#### ■ Installation height

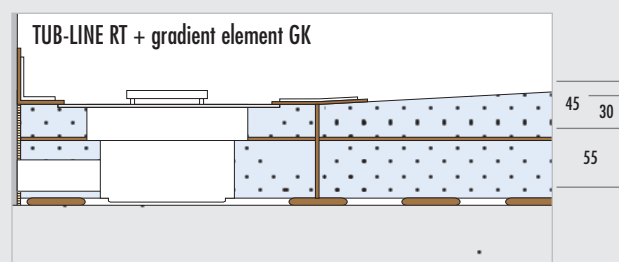





**Please note:** Dimensions in mm. Measures without adhesive coating and tiles.

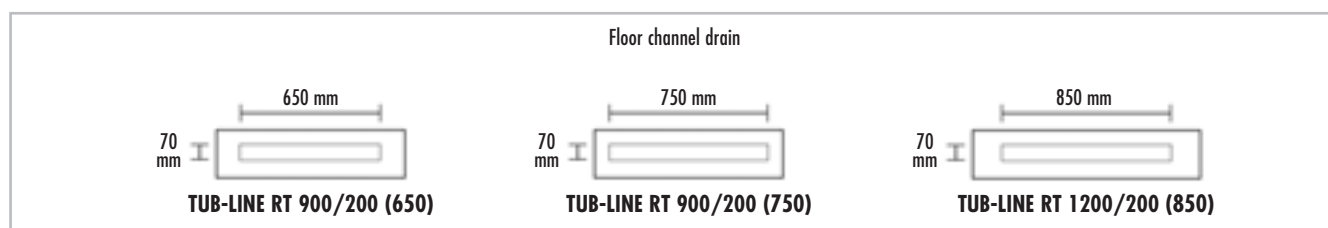

■ **PRODUCT SPECIFICATIONS – LUX ELEMENTS®-TUB-LINE RT / GK** Packaging specifications see p. 142 · Online calculator see p. 7 · \* standard-compliant according to DIN 18534

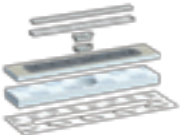
ARTICLE-NUMBER	ARTICLE-NAME / ARTICLE-DESCRIPTION	NOMINAL FORMATS/DIMENSIONS LENGTH x WIDTH x HEIGHT	UNIT	PRICE / UNIT €
----------------	------------------------------------	--	------	----------------

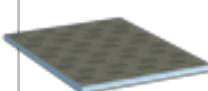

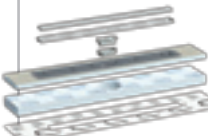
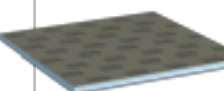
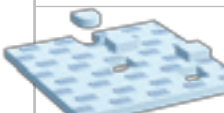
<p><b>TUB-LINE RT</b>, floor channel drain with cover rail and tiling aid made of brushed stainless steel, cover rail tileable on the rear side, with odour trap, height adjustable with height adapter from 5 – 17 mm, integrated in hard foam support element, including substrate element, including sealing sleeve. → <b>Drainage technology and accessories see page 134</b></p>					
	<b>LTUBE95008</b>	<b>TUB-LINE RT 900/200 (650)*</b> , floor channel drain 70 x 650 mm, integrated in hard foam support element, including substrate element 200 x 900 x 55 mm, including sealing sleeve 1000 x 300 mm	200 x 900 x 30 mm	set	461,01
	<b>LTUBE95001</b>	<b>TUB-LINE RT 900/200 (750)*</b> , floor channel drain 70 x 750 mm, integrated in hard foam support element, including substrate element 200 x 900 x 55 mm, including sealing sleeve 1000 x 300 mm	200 x 900 x 30 mm	set	479,48
	<b>LTUBE95002</b>	<b>TUB-LINE GK R1 1200/900*</b> , hard foam descending gradient element, sealed, with one-sided gradient	1200 x 900 x 30/45 mm	piece	225,34
	<b>LTUBE11812</b>	<b>TUB-UR 1200/900</b> , universal substrate element, rectangular, for TUB-LINE GK R1 1200/900	1200 x 900 x 55 mm	piece	91,50
	<b>LTUBE95003</b>	<b>TUB-LINE RT 1200/200 (850)*</b> , floor channel drain 70 x 850 mm, integrated in hard foam support element, including substrate element 200 x 1200 x 55 mm, including sealing sleeve 1300 x 300 mm	200 x 1200 x 30 mm	set	508,14
	<b>LTUBE95004</b>	<b>TUB-LINE GK Q1 1200*</b> , hard foam descending gradient element, sealed, with one-sided gradient	1200 x 1200 x 30/45 mm	piece	271,93
	<b>LTUBE11113</b>	<b>TUB-UQ 1200</b> , universal substrate element, square, for TUB-LINE GK Q1 1200	1200 x 1200 x 55 mm	piece	114,61



LUX ELEMENTS manufactures individual customised and special products for TUB. These include dimensions, thicknesses, shapes etc. that deviate from the standard programme. For more information see page 5.



Visit [www.luxelements.com](http://www.luxelements.com) for further information on TUB. Data sheets, assembly instructions, test certificates and additional brochures under 'Downloads', videos under 'Practice' and on YouTube.



## Floor channel drains with separate drainage technology with extended cover rail

### TUB-LINE V RT

- Floor channel drain integrated in hard foam support element, with sealing sleeve
- With extended cover rail (non-reversible) and extended tiling aid made of brushed stainless steel for continuous wall-to-wall channel look
- Can be shortened to fit the shower area
- Height RT: 30 mm
- Height-adjustable for optimum adaptation to covering thickness
- For barrier-free construction
- Second drainage level
- Including substrate element 55 mm height
- Secure click system for fastening the drain connection fitting
- Suitable drain systems, see page 134



## Gradient elements for TUB-LINE V RT

### TUB-LINE GK

- Can be fixed on one or both sides
- Simple cutting to length on the higher side for adaptation to the room situation
- Factory sealing and prefabricated gradient
- Matching substrate elements with a height of 55 mm

### ■ Combination possibilities

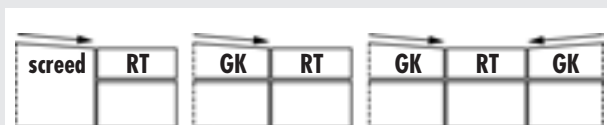

### ■ Installation height

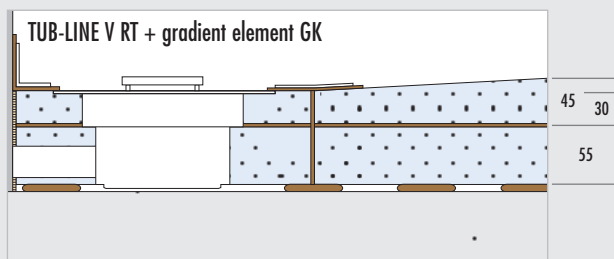

**Please note:** Dimensions in mm. Measures without adhesive coating and tiles.

### ■ Stepless adaptation

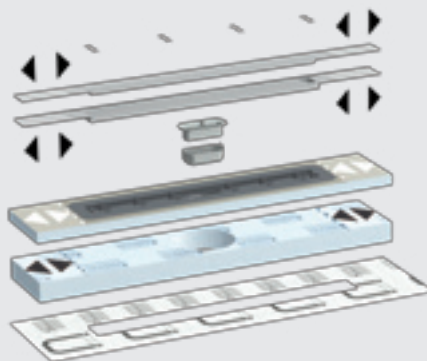

- for TUB-LINE V RT ... (650): up to 740 mm
- for TUB-LINE V RT ... (850): up to 940 mm
- for TUB-LINE V RT ... (850): up to 940 mm

■ **PRODUCT SPECIFICATIONS – LUX ELEMENTS®-TUB-LINE V RT / GK** Packaging specifications see p. 142 · Online calculator see p. 7 · \* standard-compliant according to DIN 18534

ARTICLE-NUMBER	ARTICLE-NAME / ARTICLE-DESCRIPTION	NOMINAL FORMATS/DIMENSIONS LENGTH x WIDTH x HEIGHT	UNIT	PRICE / UNIT €
----------------	------------------------------------	--	------	----------------

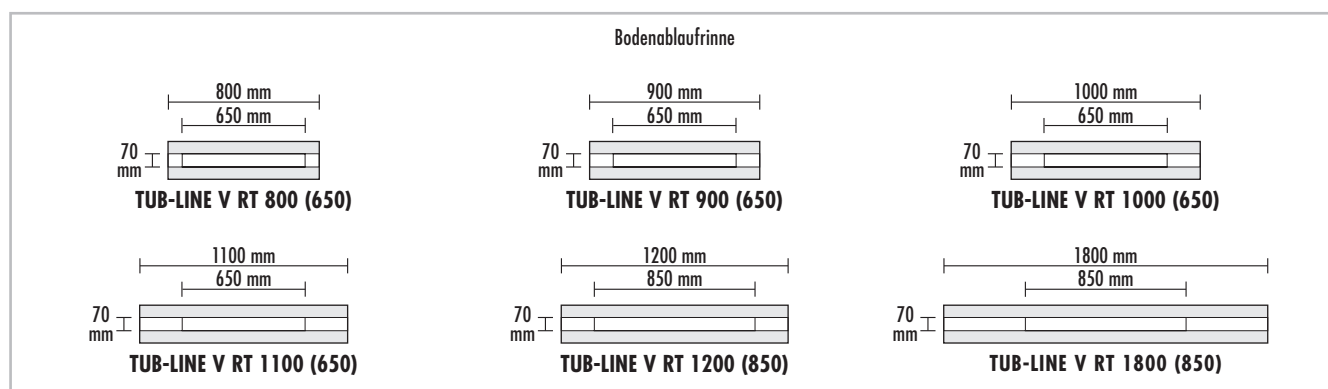

	<b>TUB-LINE V RT</b> , floor channel drain with extended tiling aid V and extended cover rail V in brushed stainless steel, with odour trap, height adjustable with height adapter from 5 – 17 mm, integrated in hard foam support element, including substrate element, including sealing sleeve. Including accessories for the stepless adaptation of the stainless steel components. → <b>Drainage technology and accessories see page 134</b>			
	<b>LTUBE98200</b>	<b>TUB-LINE V RT 800/200 (650)*</b> , with extended cover rail V, 800 mm long, including substrate element 200 x 800 x 55 mm, including sealing sleeve 900 x 300 mm	800 x 200 x 30 mm	set 549,58
	<b>LTUBE98203</b>	<b>TUB-LINE V RT 900/200 (650)*</b> , with extended cover rail V, 900 mm long, including substrate element 200 x 900 x 55 mm, including sealing sleeve 1000 x 300 mm	900 x 200 x 30 mm	set 556,82
	<b>LTUBE98201</b>	<b>TUB-LINE V RT 1000/200 (650)*</b> , with extended cover rail V, 1000 mm long, including substrate element 200 x 1000 x 55 mm, including sealing sleeve 1100 x 300 mm	200 x 1000 x 30 mm	set 564,65
	<b>LTUBE98204</b>	<b>TUB-LINE V RT 1100/200 (650)*</b> , with extended cover rail V, 1100 mm long, including substrate element 200 x 1100 x 55 mm, including sealing sleeve 1200 x 300 mm	1100 x 200 x 30 mm	set 592,93
	<b>LTUBE98202</b>	<b>TUB-LINE V RT 1200/200 (850)*</b> , with extended cover rail V, 1200 mm long, including substrate element 200 x 1200 x 55 mm, including sealing sleeve 1300 x 300 mm	200 x 1200 x 30 mm	set 603,22
	<b>LTUBE98205</b>	<b>TUB-LINE V RT 1800/200 (850)*</b> , with extended cover rail V, 1800 mm long, including substrate element 200 x 1800 x 55 mm, including sealing sleeve 1900 x 300 mm	200 x 1800 x 30 mm	set 1.046,29
	<b>TUB-LINE GK Q1</b> , hard foam descending gradient element, sealed, with one-sided gradient			
	<b>LTUBE95011</b>	<b>TUB-LINE GK Q1 800*</b> , descending gradient element	800 x 800 x 30/45 mm	piece 209,00
	<b>LTUBE95012</b>	<b>TUB-LINE GK Q1 900*</b> , descending gradient element	900 x 900 x 30/45 mm	piece 234,30
	<b>LTUBE95010</b>	<b>TUB-LINE GK R1 1000/1800*</b> , descending gradient element	1000 x 1800 x 30/45 mm	piece 246,65
	<b>LTUBE95009</b>	<b>TUB-LINE GK Q1 1000*</b> , descending gradient element	1000 x 1000 x 30/45 mm	piece 260,41
	<b>LTUBE95013</b>	<b>TUB-LINE GK Q1 1100*</b> , descending gradient element	1100 x 1100 x 30/45 mm	piece 271,93
	<b>LTUBE95004</b>	<b>TUB-LINE GK Q1 1200*</b> , descending gradient element	1200 x 1200 x 30/45 mm	piece 340,86
	<b>TUB-U</b> , substrate element			
	<b>LTUBE11110</b>	<b>TUB-UQ 800</b> , universal substrate element, square	800 x 800 x 55 mm	piece 62,51
	<b>LTUBE11111</b>	<b>TUB-UQ 900</b> , universal substrate element, square	900 x 900 x 55 mm	piece 66,76
	<b>LTUBE11112</b>	<b>TUB-UQ 1000</b> , universal substrate element, square	1000 x 1000 x 55 mm	piece 101,00
	<b>LTUBE11115</b>	<b>TUB-UQ 1100</b> , universal substrate element, square	1100 x 1100 x 55 mm	piece 110,49
	<b>LTUBE11113</b>	<b>TUB-UQ 1200</b> , universal substrate element, square	1200 x 1200 x 55 mm	piece 114,61
	<b>LTUBE98101</b>	<b>TUB-UBOL 1800/1000</b> , substrate element, rectangular	1800 x 1000 x 55 mm	piece 173,75

## ■ Systems on unfinished floors – integrated drainage technology

**LUX ELEMENTS® shower base elements**, flush with the floor and extra-flat, with integrated drainage technology (point or linear drainage) for installation on unfinished floors – ready for tiling!

### ■ General properties

	TUB-COMBI-S	TUB-PUMP-S	TUB-LINE COMBI
For barrier-free construction	■	■	■
Height-adjustable drain system	page 130	—	page 77
Factory sealing, compliant with DIN 18534	■	■	■
Integrated horizontal floor drain support	■	—	■
Grate fitting frame, factory sealed	—	—	—
Floor channel drain, factory sealed	■	—	■
Ø DN 40	■	—	—
Ø DN 50	—	■	■
Integrated and sealed-in floor drain pump	—	■	—
Prefabricated gradient	■	■	■
Extra-flat shower base height	■	—	■
Second drainage level	■	■	■
Sealing sleeve for sealing the pipe	■	—	■
Matching mounting accessories	from page 136	from page 136	from page 136
Made to measure possible	■	■	■

### ■ Installation principle, general

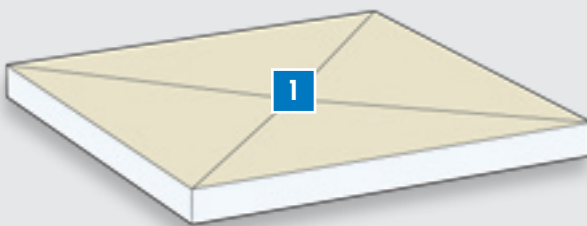

**1 Shower base element** – combination of extra-flat shower base and horizontal floor drain support (DN 40 or DN 50), factory sealed, square or rectangular, with one-sided or four-sided slope depending on drainage method (point or linear)

- Details design variants: page 77

- Details format variants: page 77

### ■ Installation heights

Dimensions in mm. Measures without adhesive coating and tiles.

#### Point drainage

TUB-COMBI-S

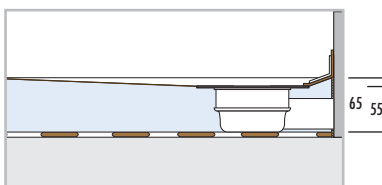

TUB-PUMP-S

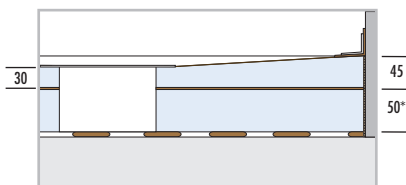

#### Linear drainage

TUB-LINE COMBI

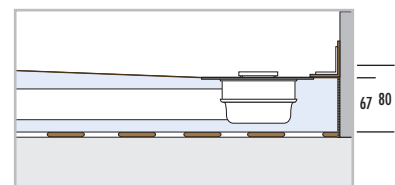

\* substrate element used depending on the installation situation

■ Properties, point drainage

**Grates/grate fitting frames** – compatible with all LUX ELEMENTS®-TUB-RA... variants, standard and design – see page 131

**Design variants** – basic shape: square or rectangular, **gradient**: four-sided, **drain position**: centre or off-centre

**Special features**: also as TUB-COMBI-S BOL with slope and shortening area, e.g. as bath tub replacement system (see page 82)

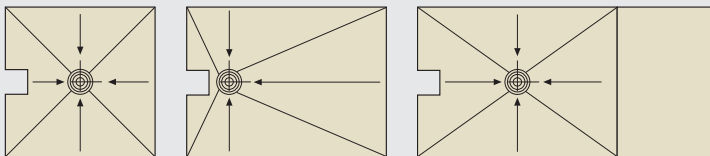

TUB-COMBI-S MQ

TUB-COMBI-S ER

TUB-COMBI-S BOL

**Grates/grate fitting frames** – two-part, reversible grate (height-adjustable) made of brushed stainless steel, tileable on rear side, allows different design variants



**Design variants** – basic shape: square or rectangular, **gradient**: four-sided, **drain position**: centre

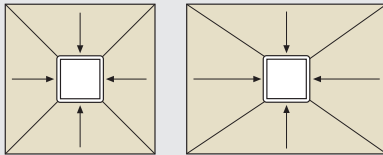

TUB-PUMP-S MQ

TUB-PUMP-S MR

■ Properties, linear drainage

**Cover rail / Floor channel drain** – dimensions: 70 x 650 mm, 70 x 750 mm or 70 x 850 mm, depending on the size of the shower base

**Special features**: reversible cover rail for two design variants (brushed stainless steel and tileable rear side), tiling aid for clean tiling, height adjustable from 5 – 17 mm using height adapter, with odour trap



**Design variants** – basic shape: square or rectangular, **gradient**: one-sided, **drain position**: on shorter side

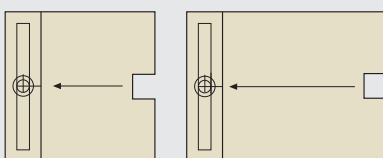

TUB-LINE COMBI Q1

TUB-LINE COMBI R1

OVERVIEW STANDARD FORMATS SQUARE

		SIDE LENGTH LENGHT				
		800 mm	900 mm	1000 mm	1100 mm	1200 mm
SIDE LENGTH WIDTH	800 mm	TUB-COMBI-S MQ (p. 81) TUB-PUMP-S MQ (p. 85) TUB-LINE COMBI Q1 (p. 87)				
	900 mm		TUB-COMBI-S MQ (p. 81) TUB-PUMP-S MQ (p. 85) TUB-LINE COMBI Q1 (p. 87)			
	1000 mm			TUB-COMBI-S MQ (p. 81) TUB-PUMP-S MQ (p. 85) TUB-LINE COMBI Q1 (p. 87)		
	1100 mm				TUB-COMBI-S MQ (p. 81) TUB-PUMP-S MQ (p. 85) TUB-LINE COMBI Q1 (p. 87)	
	1200 mm					TUB-COMBI-S MQ (p. 81) TUB-PUMP-S MQ (p. 85) TUB-LINE COMBI Q1 (p. 87)

OVERVIEW STANDARD FORMATS RECTANGULAR

		SIDE LENGTH – SHORT SIDE		
		800 mm	900 mm	1000 mm
SIDE LENGTH – LONG SIDE	900 mm	TUB-COMBI-S ER (p. 81) TUB-PUMP-S MR (p. 85) TUB-LINE COMBI R1 (p. 87)		
	1000 mm	TUB-COMBI-S ER (p. 81) TUB-PUMP-S MR (p. 85) TUB-LINE COMBI R1 (p. 87)	TUB-COMBI-S ER (p. 81) TUB-PUMP-S MR (p. 85) TUB-LINE COMBI R1 (p. 87)	
	1100 mm	TUB-COMBI-S ER (p. 81) TUB-PUMP-S MR (p. 85) TUB-LINE COMBI R1 (p. 87)	TUB-COMBI-S ER (p. 81) TUB-PUMP-S MR (p. 85) TUB-LINE COMBI R1 (p. 87)	TUB-COMBI-S ER (p. 81) TUB-PUMP-S MR (p. 85) TUB-LINE COMBI R1 (p. 87)
	1200 mm	TUB-COMBI-S ER (p. 81) TUB-PUMP-S MR (p. 85) TUB-LINE COMBI R1 (p. 87)	TUB-COMBI-S ER (p. 81) TUB-PUMP-S MR (p. 85) TUB-LINE COMBI R1 (p. 87)	TUB-COMBI-S ER (p. 81) TUB-PUMP-S MR (p. 85) TUB-LINE COMBI R1 (p. 87)
	1300 mm		TUB-COMBI-S ER (p. 81) TUB-PUMP-S MR (p. 85)	TUB-COMBI-S ER (p. 81) TUB-PUMP-S MR (p. 85)
	1400 mm		TUB-COMBI-S ER (p. 81) TUB-PUMP-S MR (p. 85)	TUB-COMBI-S ER (p. 81) TUB-PUMP-S MR (p. 85)
	1500 mm		TUB-COMBI-S ER (p. 81) TUB-PUMP-S MR (p. 85)	TUB-COMBI-S ER (p. 81) TUB-PUMP-S MR (p. 85)
	1600 mm		TUB-COMBI-S ER (p. 81) TUB-PUMP-S MR (p. 85)	TUB-COMBI-S ER (p. 81) TUB-PUMP-S MR (p. 85)
	1800 mm	TUB-COMBI-S BOL (p. 83)	TUB-COMBI-S BOL (p. 83)	TUB-COMBI-S BOL (p. 83)



Flush with the floor extra-slim shower bases with integrated drainage technology

**TUB-COMBI-S**

- Combination of shower base and horizontal floor drain support (connection DN 40)
- Factory sealing and prefabricated gradient (four-sided)
- Extra-flat shower base height: 55/65 mm
- For barrier-free construction
- Second drainage level
- Good drainage capacity: 0,8 l/s resp. 48 l/min
- Large selection of grate fitting frames depending on the covering thickness (tile + adhesive) of the shower base:
  - TUB RA-A with standard grate: from a covering thickness of 9 mm
  - TUB RA-S with standard grate: from a covering thickness of 14 mm
  - TUB-RA-DC/DM/DL/DV/DS with design grate: from a covering thickness of 14 mm



Also available as shower base for the substitution of bath tubs see TUB-COMBI-S BOL, page 82

Also available with floor channel drain, see TUB-LINE COMBI, page 86

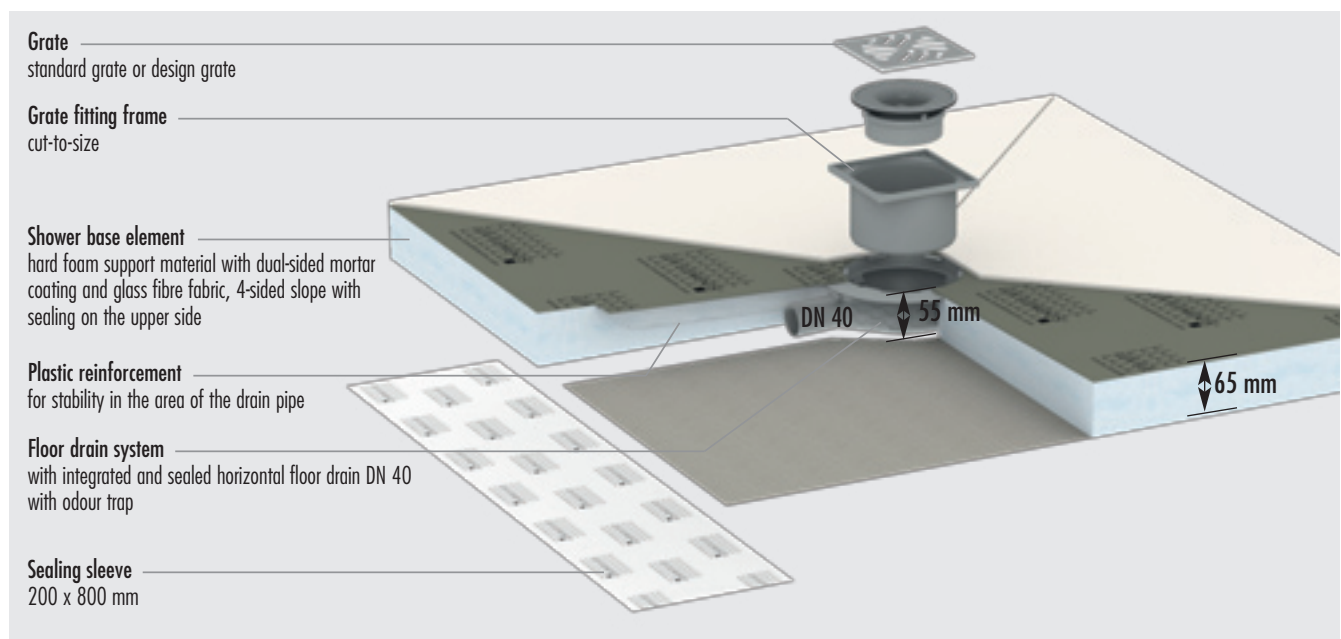
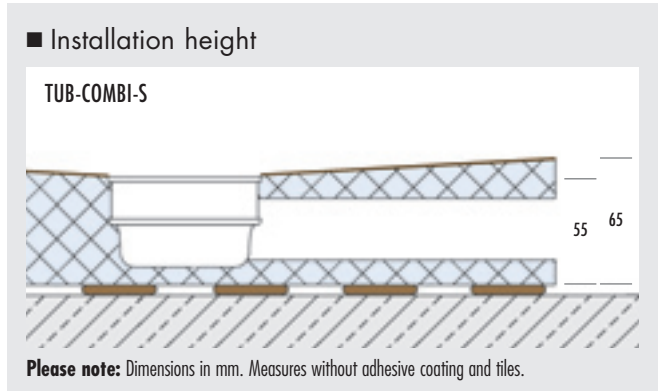



## SYSTEMS ON UNFINISHED FLOORS – SHOWERS POINT DRAINAGE / INTEGRATED DRAINAGE TECHNOLOGY

### ■ PRODUCT SPECIFICATIONS – LUX ELEMENTS®-TUB-COMBI-S

Packaging specifications see p. 142 · Online calculator see p. 7 · \* standard-compliant according to DIN 18534

ARTICLE-NUMBER	ARTICLE-NAME / ARTICLE-DESCRIPTION	NOMINAL FORMATS/DIMENSIONS LENGTH x WIDTH x HEIGHT	UNIT	PRICE / UNIT €
----------------	------------------------------------	--	------	----------------

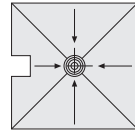

**TUB-COMBI-S MQ**

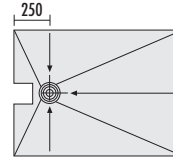

**TUB-COMBI-S ER**

**TUB-COMBI-S**, extra-slim hard foam shower base element with integrated and sealed horizontal floor drain DN 40, with odour trap, with integrated and sealed grate fitting frame and loose sealing sleeve 200 x 800 mm.  
→ Accessories see page 133

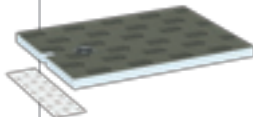
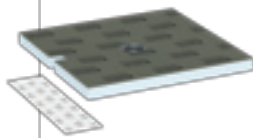

<b>LTUBE19302</b>	<b>TUB-COMBI-S MQ 800*</b> , square, drain in the centre	800 x 800 x 55/65 mm	piece	483,71
<b>LTUBE19300</b>	<b>TUB-COMBI-S MQ 900*</b> , square, drain in the centre	900 x 900 x 55/65 mm	piece	483,71
<b>LTUBE19301</b>	<b>TUB-COMBI-S MQ 1000*</b> , square, drain in the centre	1000 x 1000 x 55/65 mm	piece	508,18
<b>LTUBE19303</b>	<b>TUB-COMBI-S MQ 1100*</b> , square, drain in the centre	1100 x 1100 x 55/65 mm	piece	519,70
<b>LTUBE19304</b>	<b>TUB-COMBI-S MQ 1200*</b> , square, drain in the centre	1200 x 1200 x 55/65 mm	piece	531,02
<b>LTUBE19305</b>	<b>TUB-COMBI-S ER 900/800*</b> , rectangular, drain off-centre	900 x 800 x 55/65 mm	piece	458,42
<b>LTUBE19306</b>	<b>TUB-COMBI-S ER 1000/800*</b> , rectangular, drain off-centre	1000 x 800 x 55/65 mm	piece	474,54
<b>LTUBE19307</b>	<b>TUB-COMBI-S ER 1100/800*</b> , rectangular, drain off-centre	1100 x 800 x 55/65 mm	piece	494,27
<b>LTUBE19308</b>	<b>TUB-COMBI-S ER 1200/800*</b> , rectangular, drain off-centre	1200 x 800 x 55/65 mm	piece	517,08
<b>LTUBE19309</b>	<b>TUB-COMBI-S ER 1000/900*</b> , rectangular, drain off-centre	1000 x 900 x 55/65 mm	piece	508,18
<b>LTUBE19310</b>	<b>TUB-COMBI-S ER 1100/900*</b> , rectangular, drain off-centre	1100 x 900 x 55/65 mm	piece	527,40
<b>LTUBE19311</b>	<b>TUB-COMBI-S ER 1200/900*</b> , rectangular, drain off-centre	1200 x 900 x 55/65 mm	piece	550,60
<b>LTUBE19312</b>	<b>TUB-COMBI-S ER 1300/900*</b> , rectangular, drain off-centre	1300 x 900 x 55/65 mm	piece	569,77
<b>LTUBE19313</b>	<b>TUB-COMBI-S ER 1400/900*</b> , rectangular, drain off-centre	1400 x 900 x 55/65 mm	piece	588,79
<b>LTUBE19314</b>	<b>TUB-COMBI-S ER 1500/900*</b> , rectangular, drain off-centre	1500 x 900 x 55/65 mm	piece	604,74
<b>LTUBE19315</b>	<b>TUB-COMBI-S ER 1600/900*</b> , rectangular, drain off-centre	1600 x 900 x 55/65 mm	piece	619,53
<b>LTUBE19316</b>	<b>TUB-COMBI-S ER 1100/1000*</b> rectangular, drain off-centre	1100 x 1000 x 55/65 mm	piece	560,64
<b>LTUBE19317</b>	<b>TUB-COMBI-S ER 1200/1000*</b> rectangular, drain off-centre	1200 x 1000 x 55/65 mm	piece	583,82
<b>LTUBE19318</b>	<b>TUB-COMBI-S ER 1300/1000*</b> rectangular, drain off-centre	1300 x 1000 x 55/65 mm	piece	603,01
<b>LTUBE19319</b>	<b>TUB-COMBI-S ER 1400/1000*</b> rectangular, drain off-centre	1400 x 1000 x 55/65 mm	piece	622,18
<b>LTUBE19320</b>	<b>TUB-COMBI-S ER 1500/1000*</b> , rectangular, drain off-centre	1500 x 1000 x 55/65 mm	piece	638,15
<b>LTUBE19321</b>	<b>TUB-COMBI-S ER 1600/1000*</b> , rectangular, drain off-centre	1600 x 1000 x 55/65 mm	piece	653,09



LUX ELEMENTS manufactures individual customised and special products for TUB.

These include dimensions, thicknesses, shapes etc. that deviate from the standard programme. For more information see page 5.



Visit [www.luxelements.com](http://www.luxelements.com) for further information on TUB.

Data sheets, assembly instructions, test certificates and additional brochures under 'Downloads', videos under 'Practice' and on YouTube.



Flush with the floor extra-slim shower bases with integrated drainage technology for the substitution of bath tubs

### TUB-COMBI-S BOL

- Combination of shower base and horizontal floor drain support (connection DN 40)
- Factory sealing and prefabricated gradient (four-sided)
- Can be shortened in length through area without gradient
- Extra-flat shower base height: 55/65 mm
- For barrier-free construction
- Second drainage level
- Good drainage capacity: 0,8 l/s resp. 48 l/min

#### Accessories (optional)

- Matching benches RELAX-BA from page 46



- Shower base, can be cut to size

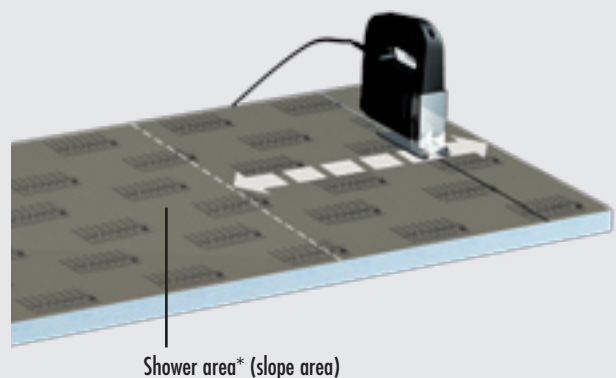

\*Please note: the fittings are to be located in the shower area

## SYSTEMS ON UNFINISHED FLOORS – SHOWERS POINT DRAINAGE / INTEGRATED DRAINAGE TECHNOLOGY

### ■ PRODUCT SPECIFICATIONS – LUX ELEMENTS®-TUB-COMBI-S BOL Packaging specifications see p. 143 · Online calculator see p. 7 · \* standard-compliant according to DIN 18534

ARTICLE-NUMBER	ARTICLE-NAME / ARTICLE-DESCRIPTION	NOMINAL FORMATS/DIMENSIONS LENGTH x WIDTH x HEIGHT	UNIT	PRICE / UNIT €
----------------	------------------------------------	---	------	----------------

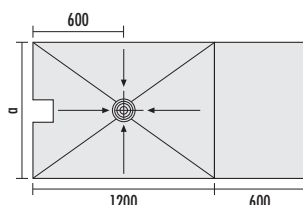

**TUB-COMBI-S BOL 1800/800: a = 800**  
**TUB-COMBI-S BOL 1800/900: a = 900**  
**TUB-COMBI-S BOL 1800/1000: a = 1000**

	<b>TUB-COMBI-S BOL</b> , extra-slim hard foam shower base element for the substitution of bath tubs, with integrated and sealed horizontal floor drain DN 40, with odour trap, with integrated and sealed grate fitting frame and loose sealing sleeve 200 x 800 mm. → Accessories see page 133				
	<b>LTUBE19322</b>	<b>TUB-COMBI-S BOL 1800/800*</b> , can be cut to a minimum of 800 x 1200 mm, gradient area from 800 x 1200 mm	1800 x 800 x 55/65 mm	piece	629,95
	<b>LTUBE19323</b>	<b>TUB-COMBI-S BOL 1800/900*</b> , can be cut to a minimum of 900 x 1200 mm, gradient area from 900 x 1200 mm	1800 x 900 x 55/65 mm	piece	650,26
	<b>LTUBE19324</b>	<b>TUB-COMBI-S BOL 1800/1000*</b> , can be cut to a minimum of 1000 x 1200 mm, gradient area from 1000 x 1200 mm	1800 x 1000 x 55/65 mm	piece	683,50



LUX ELEMENTS manufactures individual customised and special products for TUB. These include dimensions, thicknesses, shapes etc. that deviate from the standard programme. For more information see page 5.



Visit [www.luxelements.com](http://www.luxelements.com) for further information on TUB. Data sheets, assembly instructions, test certificates and additional brochures under 'Downloads', videos under 'Practice' and on YouTube.



Flush with the floor shower bases with integrated floor drain pump  
**TUB-PUMP**

**TUB-PUMP-S**

- Shower base element with integrated and sealed-in floor drain pump
- Prefabricated gradient (four-sided)
- 95 mm installation height (without adhesive coating)
- Pumps water upwards if it cannot reach the drainpipe by gravity flow
- Suitable for the installation of a flush with the floor shower in case of renovations where the connection point to the soil stack is a few centimetres too high
- Float-controlled – switches on independent of the water inlet through the pipe
- Two-part, brushed stainless steel, reversible grate, tileable on rear side, allows different design variants
- Height-adjustable reversible grate
- Drainage capacity: 25 l/min with a height difference of 0,6 m

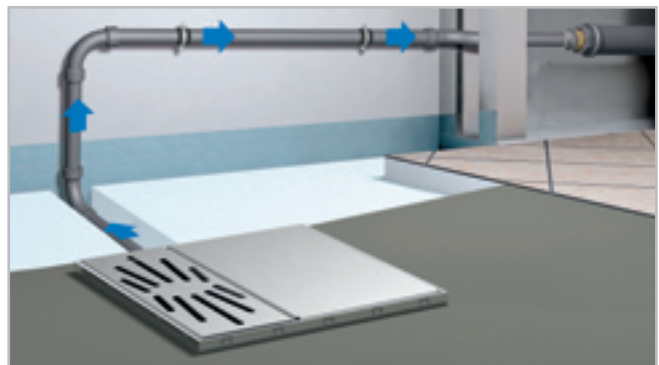

**TUB-PUMP**

Also available as product variant TUB-PUMP with powerful floor drain pump with an installation height of 125 mm excluding adhesive coating.

For further information and technical data, see the LUX ELEMENTS®-TUB-PUMP data sheet. Price on request.



■ Performances

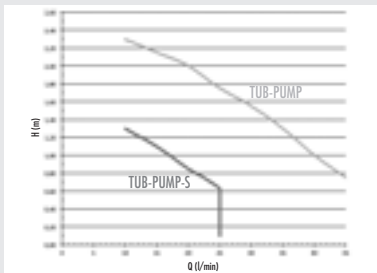

Pumping height H [m]	0,1	0,75	1,0	1,5	2,0
Output volume Q [l/s] TUB-PUMP-S ...	0,43	0,38	0,27		
Output volume Q [l/s] TUB-PUMP ...		0,77	0,67	0,52	0,33

■ Installation height TUB-PUMP-S

\* substrate element used depending on the installation situation

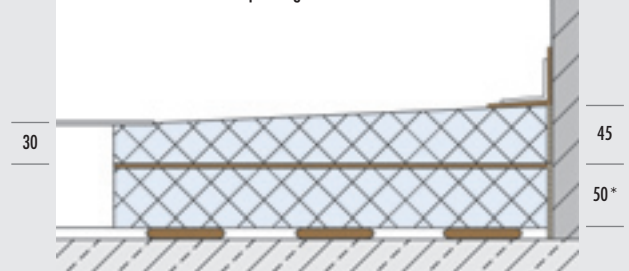

**Please note:** Dimensions in mm. Measures without adhesive coating and tiles.

## SYSTEMS ON UNFINISHED FLOORS – SHOWERS POINT DRAINAGE / INTEGRATED DRAINAGE TECHNOLOGY

### ■ PRODUCT SPECIFICATIONS – LUX ELEMENTS®-TUB-PUMP

Packaging specifications see p. 143 · Online calculator see p. 7 · \* standard-compliant according to DIN 18534

ARTICLE-NUMBER	ARTICLE-NAME / ARTICLE-DESCRIPTION	NOMINAL FORMATS/DIMENSIONS LENGTH x WIDTH x HEIGHT	UNIT	PRICE / UNIT €
----------------	------------------------------------	--	------	----------------

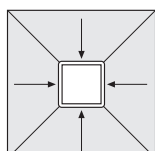

**TUB-PUMP-S MQ**

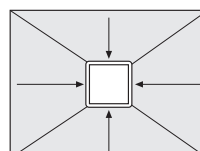

**TUB-PUMP-S MR**

	<b>TUB-PUMP-S</b> , hard foam shower base element with integrated and sealed-in floor drain pump, installation height 95 mm (45+50 mm) without adhesive coating, incl. 2 substrate elements (height 50 and 30 mm, used depending on the installation situation), cover made of stainless steel, cover tileable on the rear side.			
	<b>LTUBE19209</b>	<b>TUB-PUMP-S MQ 800*</b> , square	800 x 800 x 30/45 mm	set 1.747,99
	<b>LTUBE19205</b>	<b>TUB-PUMP-S MQ 900*</b> , square	900 x 900 x 30/45 mm	set 1.766,81
	<b>LTUBE19210</b>	<b>TUB-PUMP-S MQ 1000*</b> , square	1000 x 1000 x 30/45 mm	set 1.823,34
	<b>LTUBE19211</b>	<b>TUB-PUMP-S MQ 1100*</b> , square	1100 x 1100 x 30/45 mm	set 1.879,88
	<b>LTUBE19206</b>	<b>TUB-PUMP-S MQ 1200*</b> , square	1200 x 1200 x 30/45 mm	set 1.936,41
	<b>LTUBE19212</b>	<b>TUB-PUMP-S MR 900/800*</b> , rectangular	900 x 800 x 30/45 mm	set 1.756,76
	<b>LTUBE19213</b>	<b>TUB-PUMP-S MR 1000/800*</b> , rectangular	1000 x 800 x 30/45 mm	set 1.768,11
	<b>LTUBE19214</b>	<b>TUB-PUMP-S MR 1100/800*</b> , rectangular	1100 x 800 x 30/45 mm	set 1.779,46
	<b>LTUBE19215</b>	<b>TUB-PUMP-S MR 1200/800*</b> , rectangular	1200 x 800 x 30/45 mm	set 1.790,81
	<b>LTUBE19216</b>	<b>TUB-PUMP-S MR 1000/900*</b> , rectangular	1000 x 900 x 30/45 mm	set 1.777,43
	<b>LTUBE19217</b>	<b>TUB-PUMP-S MR 1100/900*</b> , rectangular	1100 x 900 x 30/45 mm	set 1.793,33
	<b>LTUBE19207</b>	<b>TUB-PUMP-S MR 1200/900*</b> , rectangular	1200 x 900 x 30/45 mm	set 1.809,22
	<b>LTUBE19218</b>	<b>TUB-PUMP-S MR 1300/900*</b> , rectangular	1300 x 900 x 30/45 mm	set 1.837,49
	<b>LTUBE19208</b>	<b>TUB-PUMP-S MR 1400/900*</b> , rectangular	1400 x 900 x 30/45 mm	set 1.865,75
	<b>LTUBE19219</b>	<b>TUB-PUMP-S MR 1500/900*</b> , rectangular	1500 x 900 x 30/45 mm	set 1.901,03
	<b>LTUBE19220</b>	<b>TUB-PUMP-S MR 1600/900*</b> , rectangular	1600 x 900 x 30/45 mm	set 1.936,31
<b>LTUBE19221</b>	<b>TUB-PUMP-S MR 1100/1000*</b> , rectangular	1100 x 1000 x 30/45 mm	set 1.852,14	
<b>LTUBE19222</b>	<b>TUB-PUMP-S MR 1200/1000*</b> , rectangular	1200 x 1000 x 30/45 mm	set 1.880,10	
<b>LTUBE19223</b>	<b>TUB-PUMP-S MR 1300/1000*</b> , rectangular	1300 x 1000 x 30/45 mm	set 1.910,14	
<b>LTUBE19224</b>	<b>TUB-PUMP-S MR 1400/1000*</b> , rectangular	1400 x 1000 x 30/45 mm	set 1.936,63	
<b>LTUBE19225</b>	<b>TUB-PUMP-S MR 1500/1000*</b> , rectangular	1500 x 1000 x 30/45 mm	set 1.964,90	
<b>LTUBE19226</b>	<b>TUB-PUMP-S MR 1600/1000*</b> , rectangular	1600 x 1000 x 30/45 mm	set 1.993,17	



LUX ELEMENTS manufactures individual customised and special products for TUB.

These include dimensions, thicknesses, shapes etc. that deviate from the standard programme. For more information see page 5.



Visit [www.luxelements.com](http://www.luxelements.com) for further information on TUB.

Data sheets, assembly instructions, test certificates and additional brochures under 'Downloads', videos under 'Practice' and on YouTube.



Flush with the floor extra-slim shower bases with integrated drainage technology

**TUB-LINE COMBI**

- Combination of shower base with built-in and sealed floor channel drain (70 x 650 mm, 70 x 750 mm or 70 x 850 mm) and horizontal floor drain support (including odour trap)
- Factory sealing
- Prefabricated gradient (one-sided)
- Extra-flat shower base height: 67/80 mm
- Reversible channel cover rail offers two design options
- Clean tiling with tiling aid
- Height-adjustable for optimum adaptation to covering thickness
- Including sealing sleeve for sealing the pipe
- For barrier-free construction
- Second drainage level
- Drainage capacity 0,52 l/s (higher than required by standard)

Also available with point drainage, see TUB-COMBI-S, page 80

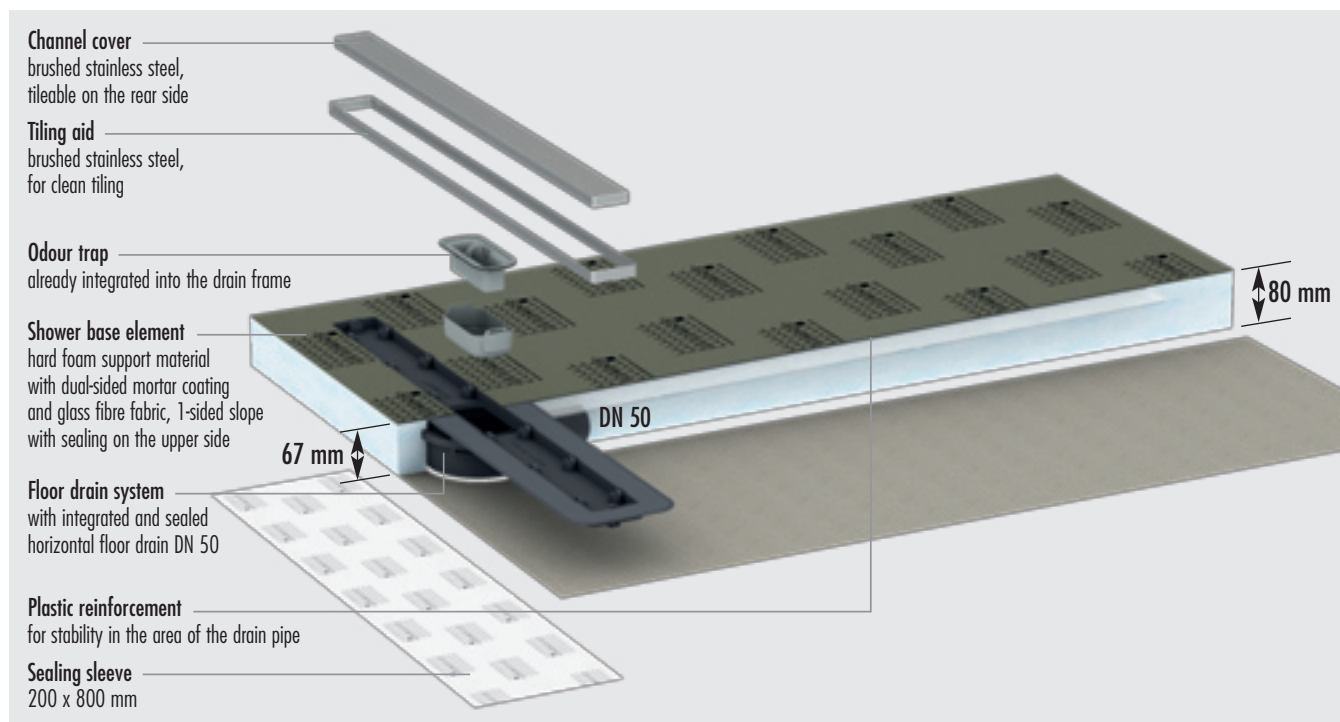
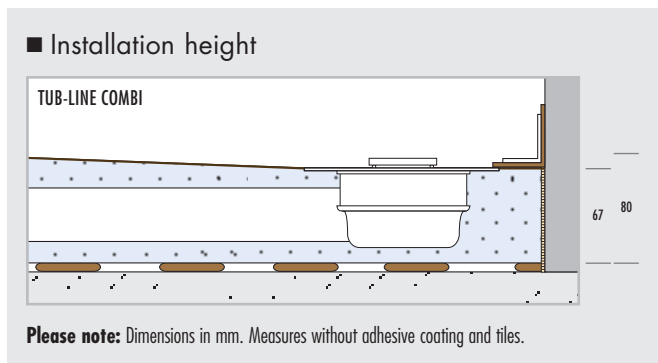

## SYSTEMS ON UNFINISHED FLOORS – SHOWERS LINEAR DRAINAGE / INTEGRATED DRAINAGE TECHNOLOGY

### ■ PRODUCT SPECIFICATIONS – LUX ELEMENTS®-TUB-LINE COMBI Packaging specifications see p. 144 · Online calculator see p. 7 · \* standard-compliant according to DIN 18534

ARTICLE-NUMBER	ARTICLE-NAME / ARTICLE-DESCRIPTION	NOMINAL FORMATS/DIMENSIONS LENGTH x WIDTH x HEIGHT	UNIT	PRICE / UNIT €
----------------	------------------------------------	--	------	----------------

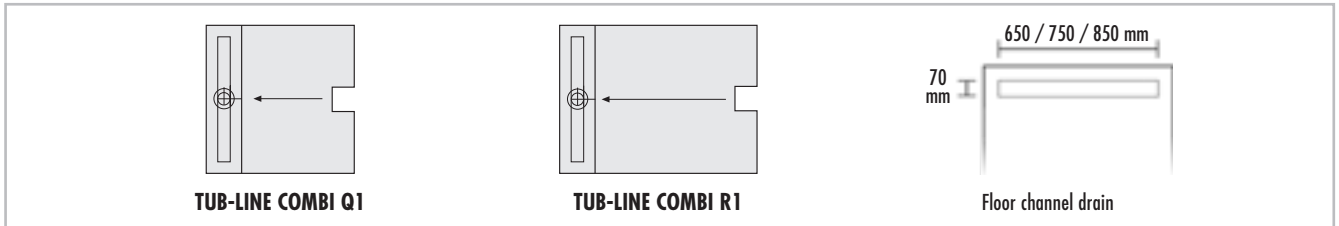

<p><b>TUB-LINE COMBI</b>, extra-slim hard foam shower base element with integrated and sealed floor channel drain, with cover rail and tiling aid made of brushed stainless steel, cover rail tileable on the rear side, with odour trap, height adjustable with height adapter from 5–17 mm, with 1-sided gradient, with integrated horizontal drain support, including loose sealing sleeve 200 x 800 mm. → Accessories see page 134</p>					
<b>with floor channel drain 70 x 650 mm</b>					
	LTUBE9324	TUB-LINE COMBI Q1 800*, square	800 x 800 x 67/80 mm	piece 800,44	
	<b>with floor channel drain 70 x 750 mm</b>				
	LTUBE9322	TUB-LINE COMBI Q1 900*, square	900 x 900 x 67/80 mm	piece 838,12	
<b>with floor channel drain 70 x 850 mm</b>					
	LTUBE9325	TUB-LINE COMBI Q1 1000*, square	1000 x 1000 x 67/80 mm	piece 910,52	
	LTUBE9326	TUB-LINE COMBI Q1 1100*, square	1100 x 1100 x 67/80 mm	piece 939,48	
	LTUBE9327	TUB-LINE COMBI Q1 1200*, square	1200 x 1200 x 67/80 mm	piece 968,62	
	<b>with floor channel drain 70 x 650 mm</b>				
	LTUBE9328	TUB-LINE COMBI R1 900/800*, rectangular	900 x 800 x 67/80 mm	piece 801,77	
	LTUBE9329	TUB-LINE COMBI R1 1000/800*, rectangular	1000 x 800 x 67/80 mm	piece 817,87	
	LTUBE9334	TUB-LINE COMBI R1 1100/800*, rectangular	1100 x 800 x 67/80 mm	piece 831,83	
	LTUBE9335	TUB-LINE COMBI R1 1200/800*, rectangular	1200 x 800 x 67/80 mm	piece 846,44	
	<b>with floor channel drain 70 x 750 mm</b>				
	LTUBE9336	TUB-LINE COMBI R1 1000/900*, rectangular	1000 x 900 x 67/80 mm	piece 836,95	
	LTUBE9337	TUB-LINE COMBI R1 1100/900*, rectangular	1100 x 900 x 67/80 mm	piece 858,48	
	LTUBE9323	TUB-LINE COMBI R1 1200/900*, rectangular	1200 x 900 x 67/80 mm	piece 880,28	
	<b>with floor channel drain 70 x 850 mm</b>				
	LTUBE9338	TUB-LINE COMBI R1 1100/1000*, rectangular	1100 x 1000 x 67/80 mm	piece 922,50	
LTUBE9339	TUB-LINE COMBI R1 1200/1000*, rectangular	1200 x 1000 x 67/80 mm	piece 940,61		



LUX ELEMENTS manufactures individual customised and special products for TUB. These include dimensions, thicknesses, shapes etc. that deviate from the standard programme. For more information see page 5.



Visit [www.luxelements.com](http://www.luxelements.com) for further information on TUB. Data sheets, assembly instructions, test certificates and additional brochures under 'Downloads', videos under 'Practice' and on YouTube.

## ■ Systems on unfinished floors – separate drainage technology

**LUX ELEMENTS® shower base elements**, flush with the floor, with separate drainage technology (point or linear drainage) for installation on unfinished floors – ready for tiling!

### ■ General properties

	TUB	TUB-LINE
For barrier-free construction	■	■
Height-adjustable drain system	page 130	page 89
Factory sealing, compliant with DIN 18534	■	■
Gate fitting frame, factory sealed	■	—
Floor channel drain, factory sealed	—	■
Prefabricated gradient, 30/45 mm	■	■
Second drainage level	■	■
Optional: matching substrate element, 55 mm	from page 114	from page 114
Click system for fastening the drain connection fitting	■	■
Separate floor drain support, vertical or horizontal	from page 130	from page 134
Extensive accessories	page 133	page 135
Matching mounting accessories	from page 136	from page 136
Made to measure possible	■	■

### ■ Installation principle, general

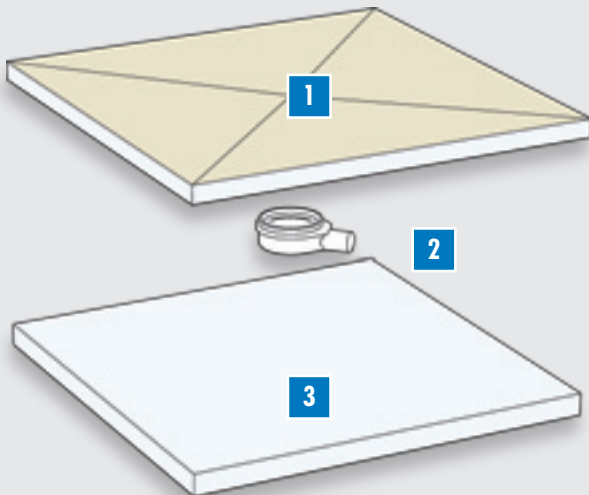

**1 Shower base element** – factory sealed, square or rectangular, depending on drainage method (point or linear drainage) with one-sided or four-sided gradient, integrated and sealed floor drain system

- Details design variants: page 89
- Details format variants: page 89

**2 Drain support** – vertical (DN 40 or DN 50) or horizontal (DN 50) freely selectable depending on requirements; simple, fast and safe mounting by means of click system without gluing or screwing

- Details: from page 130 (point drainage)
- Details: page 134 (linear drainage)

**3 Substrate element** – optional, to match shower base element, either universal or made to measure, for optimal height adjustment depending on the installation situation

- Details: from page 114

### ■ Installation heights, general

Dimensions in mm. Measures without adhesive coating and tiles.

Floor drain support vertical without substrate element



Floor drain support vertical with substrate element

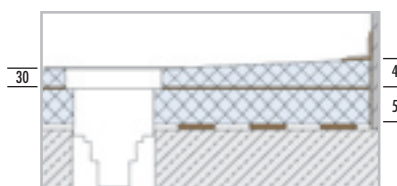

Floor drain support horizontal with substrate element

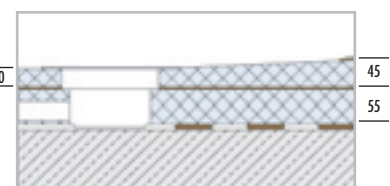

Please note: The overall height when installing the vertical drain without a substrate element is reduced by the height of the substrate element (= 55 mm). For further details, please see technical data sheet TUB(-LINE) ...



■ Properties, point drainage

**Grates/grate fitting frames** – compatible with all LUX ELEMENTS®-TUB-RA... variants, standard and design – see page 131

**Design variants** – basic shape: square or rectangular, **gradient**: four-sided, **drain position**: corner, centre or off-centre

**Special features**: also as TUB-BOL with slope and shortening area, e.g. as bath tub replacement system (see page 96)

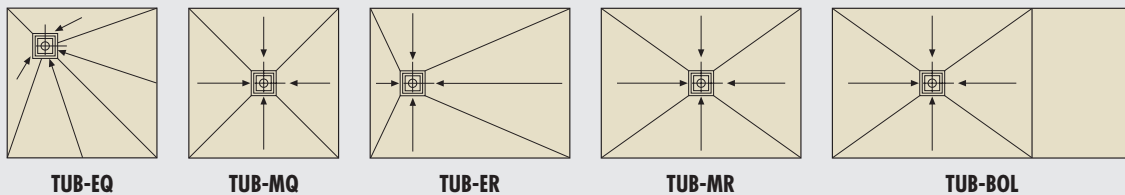

■ Properties, linear drainage

**Cover rail / Floor channel drain** – dimensions: 70 x 650 mm, 70 x 750 mm or 70 x 850 mm, depending on the size of the shower base

**Special features**: reversible cover rail for two design variants (brushed stainless steel and tileable rear side), tiling aid for clean tiling, height adjustable from 5 – 17 mm using height adapter, with odour trap



**Design variants** – basic shape: square or rectangular, **gradient**: one-sided or four-sided, **drain position**: on shorter side

**Special features**: also as TUB-LINE BOL with slope and shortening area, e.g. as bath tub replacement system (see page 106)

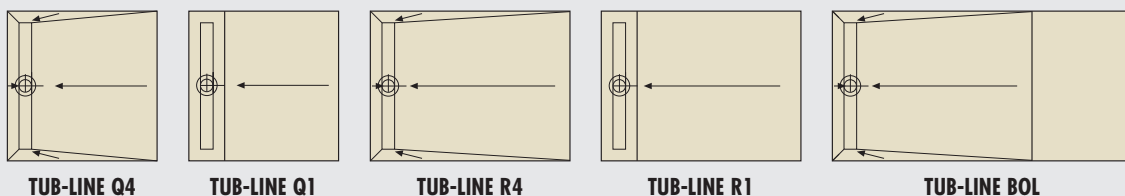

**Extended cover rail V** – dimensions: 70 x 800 / 900 / 1000 / 1100 / 1200 mm, depending on the size of the shower base

**Special features**: brushed stainless steel (non-reversible), can be shortened (Including accessories for the stepless adaptation of the stainless steel components), tiling aid for clean tiling, height adjustable from 5 – 17 mm using height adapter, with odour trap

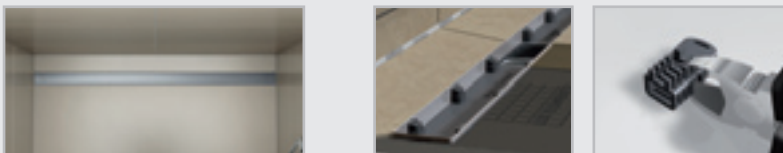

**Design variants** – basic shape: square or rectangular, **gradient**: one-sided, **drain position**: on shorter side

**Special features**: also as TUB-LINE BOL V R1 with slope and shortening area, e.g. as bath tub replacement system (see page 110)

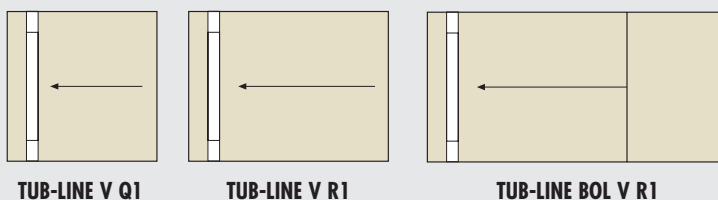

OVERVIEW STANDARD FORMATS SQUARE

For more formats made to measure see product data tables.

		SIDE LENGTH LENGTH					
		800 mm	900 mm	1000 mm	1100 mm	1200 mm	1500 mm
SIDE LENGTH WIDTH	800 mm	TUB-EQ (p. 93) TUB-MQ (p. 93) TUB-LINE Q4 (p. 101) TUB-LINE Q1 (p. 101) TUB-LINE V Q1 (p. 109)					
	900 mm		TUB-EQ (p. 93) TUB-MQ (p. 93) TUB-FW MQ (p. 99) TUB-LINE Q4 (p. 101) TUB-LINE Q1 (p. 101) TUB-LINE V Q1 (p. 109) TUB-LINE FW Q4 (p. 113)				
	1000 mm			TUB-EQ (p. 93) TUB-MQ (p. 93) TUB-LINE Q4 (p. 101) TUB-LINE Q1 (p. 101) TUB-LINE V Q1 (p. 109)			
	1100 mm				TUB-EQ (p. 93) TUB-MQ (p. 93) TUB-LINE V Q1 (p. 109)		
	1200 mm					TUB-EQ (p. 93) TUB-MQ (p. 93) TUB-LINE Q4 (p. 101) TUB-LINE Q1 (p. 101) TUB-LINE V Q1 (p. 109)	
	1500 mm						TUB-EQ (p. 93) TUB-MQ (p. 93)

OVERVIEW STANDARD FORMATS RECTANGULAR

For more formats made to measure see product data tables.

		SIDE LENGTH – SHORT SIDE			
		800 mm	900 mm	1000 mm	1200 mm
SIDE LENGTH – LONG SIDE	900 mm	TUB-ER (p. 94) / TUB-MR (p. 95) TUB-LINE R4 (p. 102) / TUB-LINE R1 (p. 104) TUB-LINE V R1 (p. 109)			
	1000 mm	TUB-ER (p. 94) / TUB-MR (p. 95) TUB-LINE R4 (p. 102) / TUB-LINE R1 (p. 104) TUB-LINE V R1 (p. 109)	TUB-ER (p. 94) / TUB-MR (p. 95) TUB-LINE R4 (p. 102) / TUB-LINE R1 (p. 104) TUB-LINE V R1 (p. 109)		
	1100 mm	TUB-ER (p. 94) / TUB-MR (p. 95) TUB-LINE R4 (p. 102) / TUB-LINE R1 (p. 104) TUB-LINE V R1 (p. 109)	TUB-ER (p. 94) / TUB-MR (p. 95) TUB-LINE R4 (p. 102) / TUB-LINE R1 (p. 104) TUB-LINE V R1 (p. 109)	TUB-ER (p. 94) / TUB-MR (p. 95) TUB-LINE R4 (p. 102) / TUB-LINE R1 (p. 104) TUB-LINE V R1 (p. 109)	
	1200 mm	TUB-ER (p. 94) / TUB-MR (p. 95) TUB-LINE R4 (p. 102) / TUB-LINE R1 (p. 104) TUB-LINE V R1 (p. 109)	TUB-ER (p. 94) / TUB-MR (p. 95) TUB-FW ER (p. 99) TUB-LINE R4 (p. 102) / TUB-LINE R1 (p. 104) TUB-LINE V R1 (p. 109) TUB-LINE FW R4 (p. 113)	TUB-ER (p. 94) / TUB-MR (p. 95) TUB-LINE R4 (p. 102) / TUB-LINE R1 (p. 104) TUB-LINE V R1 (p. 109)	
	1300 mm		TUB-ER (p. 94) / TUB-MR (p. 95) TUB-LINE R4 (p. 102) / TUB-LINE R1 (p. 104) TUB-LINE V R1 (p. 109)	TUB-ER (p. 94) / TUB-MR (p. 95) TUB-LINE R4 (p. 102) / TUB-LINE R1 (p. 104) TUB-LINE V R1 (p. 109)	
	1400 mm		TUB-ER (p. 94) / TUB-MR (p. 95) TUB-LINE R4 (p. 102) / TUB-LINE R1 (p. 104) TUB-LINE V R1 (p. 109)	TUB-ER (p. 94) / TUB-MR (p. 95) TUB-LINE R4 (p. 102) / TUB-LINE R1 (p. 104) TUB-LINE V R1 (p. 109)	
	1500 mm		TUB-ER (p. 94) / TUB-MR (p. 95) TUB-LINE R4 (p. 102) / TUB-LINE R1 (p. 104) TUB-LINE V R1 (p. 109)	TUB-ER (p. 94) / TUB-MR (p. 95) TUB-LINE R4 (p. 102) / TUB-LINE R1 (p. 104) TUB-LINE V R1 (p. 109)	
	1600 mm		TUB-ER (p. 94) / TUB-MR (p. 95) TUB-FW ER (p. 99) TUB-LINE R4 (p. 102) / TUB-LINE R1 (p. 104) TUB-LINE V R1 (p. 109) TUB-LINE FW R4 (p. 113)	TUB-ER (p. 94) / TUB-MR (p. 95) TUB-LINE R4 (p. 102) / TUB-LINE R1 (p. 104) TUB-LINE V R1 (p. 109)	
	1800 mm	TUB-BOL (p. 97) TUB-LINE BOL (p. 107) TUB-LINE BOL V R1 (p. 111)	TUB-BOL (p. 97) TUB-LINE BOL (p. 107) TUB-LINE BOL V R1 (p. 111)	TUB-BOL (p. 97) TUB-LINE BOL (p. 107) TUB-LINE BOL V R1 (p. 111)	TUB-LINE BOL V R1 (p. 111)



Flush with the floor shower bases with separate drainage technology with point drainage

## TUB

- Factory sealing
- Sealed floor drain fitting frame
- Prefabricated gradient (four-sided)
- Shower base height: 30/45 mm
- For barrier-free construction
- Second drainage level
- Matching substrate elements with a height of 55 mm, see page 114
- Secure click system for fastening the drain connection fitting
- Suitable drain systems, see page 130–133



### ■ Installation heights

Floor drain support vertical without substrate element

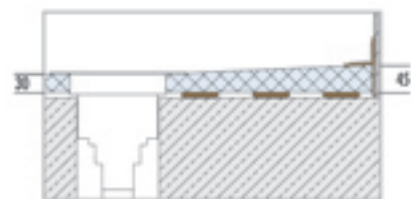

Floor drain support vertical with substrate element



Floor drain support horizontal with substrate element

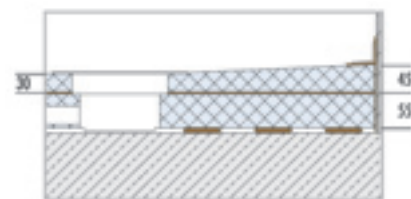

**Please note:** Dimensions in mm. Measures without adhesive coating and tiles. For further details, please see technical data sheet TUB.

## SYSTEMS ON UNFINISHED FLOORS – SHOWERS POINT DRAINAGE / SEPARATE DRAINAGE TECHNOLOGY

### ■ PRODUCT SPECIFICATIONS – LUX ELEMENTS®-TUB-EQ / -MQ

Packaging specifications see p. 144 · Online calculator see p. 7 · \* standard-compliant according to DIN 18534

ARTICLE-NUMBER	ARTICLE-NAME / ARTICLE-DESCRIPTION	NOMINAL FORMATS/DIMENSIONS LENGTH x WIDTH x HEIGHT	UNIT	PRICE / UNIT €
----------------	------------------------------------	--	------	----------------

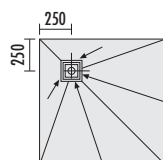

**TUB-EQ**

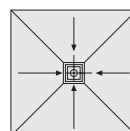

**TUB-MQ**

	<b>TUB-EQ</b> , hard foam shower base elements, square, with integrated and sealed floor drain support frame 135 x 135 mm in the corner. → Substrate elements see page 114–115 / Drainage technology and accessories see page 130–133			
	LTUBE10000	TUB-EQ 800*, standard format	800 x 800 x 30/45 mm	330,77
	LTUBE10001	TUB-EQ 900*, standard format	900 x 900 x 30/45 mm	330,77
	LTUBE10002	TUB-EQ 1000*, standard format	1000 x 1000 x 30/45 mm	353,74
	LTUBE10009	TUB-EQ 1100*, standard format	1100 x 1100 x 30/45 mm	364,56
	LTUBE10003	TUB-EQ 1200*, standard format	1200 x 1200 x 30/45 mm	375,38
	LTUBE10004	TUB-EQ 1500*, standard format	1500 x 1500 x 30/45 mm	550,38
	LTUBE10005	TUB-EQ 1–1000*, made to measure	1–1000 x 30/45 mm	419,37
	LTUBE10006	TUB-EQ 1001–1200*, made to measure	1001–1200 x 30/45 mm	499,29
LTUBE10007	TUB-EQ 1201–1400*, made to measure	1201–1400 x 30/45 mm	608,92	
	<b>TUB-MQ</b> , hard foam shower base elements, square, with integrated and sealed floor drain support frame 135 x 135 mm in the centre. → Substrate elements see page 114–115 / Drainage technology and accessories see page 130–133			
	LTUBE10100	TUB-MQ 800*, standard format	800 x 800 x 30/45 mm	330,77
	LTUBE10101	TUB-MQ 900*, standard format	900 x 900 x 30/45 mm	330,77
	LTUBE10102	TUB-MQ 1000*, standard format	1000 x 1000 x 30/45 mm	353,74
	LTUBE10109	TUB-MQ 1100*, standard format	1100 x 1100 x 30/45 mm	364,56
	LTUBE10103	TUB-MQ 1200*, standard format	1200 x 1200 x 30/45 mm	375,38
	LTUBE10104	TUB-MQ 1500*, standard format	1500 x 1500 x 30/45 mm	550,38
	LTUBE10105	TUB-MQ 1–1000*, made to measure	1–1000 x 30/45 mm	419,37
	LTUBE10106	TUB-MQ 1001–1200*, made to measure	1001–1200 x 30/45 mm	499,29
LTUBE10107	TUB-MQ 1201–1400*, made to measure	1201–1400 x 30/45 mm	608,92	



LUX ELEMENTS manufactures individual customised and special products for TUB.

These include dimensions, thicknesses, shapes etc. that deviate from the standard programme. For more information see page 5.



Visit [www.luxelements.com](http://www.luxelements.com) for further information on TUB.

Data sheets, assembly instructions, test certificates and additional brochures under 'Downloads', videos under 'Practice' and on YouTube.

■ PRODUCT SPECIFICATIONS – LUX ELEMENTS®-TUB-ER

Packaging specifications see p. 145 · Online calculator see p. 7 · \* standard-compliant according to DIN 18534

ARTICLE-NUMBER	ARTICLE-NAME / ARTICLE-DESCRIPTION	NOMINAL FORMATS/DIMENSIONS LENGTH x WIDTH x HEIGHT	UNIT	PRICE / UNIT €
----------------	------------------------------------	--	------	----------------

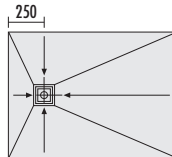

TUB-ER

**TUB-ER**, hard foam shower base elements, rectangular, integrated and sealed floor drain support frame 135 x 135 mm off-centre.  
 → Substrate elements see page 114–115 / Drainage technology and accessories see page 130–133

LTUBE10616	TUB-ER 900/800*, standard format	900 x 800 x 30/45 mm	piece	307,02
LTUBE10614	TUB-ER 1000/800*, standard format	1000 x 800 x 30/45 mm	piece	322,16
LTUBE10617	TUB-ER 1100/800*, standard format	1100 x 800 x 30/45 mm	piece	340,68
LTUBE10618	TUB-ER 1200/800*, standard format	1200 x 800 x 30/45 mm	piece	362,10
LTUBE10619	TUB-ER 1000/900*, standard format	1000 x 900 x 30/45 mm	piece	353,74
LTUBE10620	TUB-ER 1100/900*, standard format	1100 x 900 x 30/45 mm	piece	371,79
LTUBE10601	TUB-ER 1200/900*, standard format	1200 x 900 x 30/45 mm	piece	393,57
LTUBE10615	TUB-ER 1300/900*, standard format	1300 x 900 x 30/45 mm	piece	411,57
LTUBE10603	TUB-ER 1400/900*, standard format	1400 x 900 x 30/45 mm	piece	429,43
LTUBE10604	TUB-ER 1500/900*, standard format	1500 x 900 x 30/45 mm	piece	444,41
LTUBE10605	TUB-ER 1600/900*, standard format	1600 x 900 x 30/45 mm	piece	458,30
LTUBE10621	TUB-ER 1100/1000*, standard format	1100 x 1000 x 30/45 mm	piece	403,01
LTUBE10602	TUB-ER 1200/1000*, standard format	1200 x 1000 x 30/45 mm	piece	424,76
LTUBE10622	TUB-ER 1300/1000*, standard format	1300 x 1000 x 30/45 mm	piece	462,71
LTUBE10623	TUB-ER 1400/1000*, standard format	1400 x 1000 x 30/45 mm	piece	481,53
LTUBE10624	TUB-ER 1500/1000*, standard format	1500 x 1000 x 30/45 mm	piece	497,19
LTUBE10625	TUB-ER 1600/1000*, standard format	1600 x 1000 x 30/45 mm	piece	511,85
LTUBE10606	TUB-ER 1–1000*, made to measure	1–1000 x 30/45 mm	piece	419,37
LTUBE10607	TUB-ER 1001–1200*, made to measure	1001–1200 x 30/45 mm	piece	476,84
LTUBE10608	TUB-ER 1201–1400*, made to measure	1201–1400 x 30/45 mm	piece	579,87
LTUBE10609	TUB-ER 1401–1600*, made to measure	1401–1600 x 30/45 mm	piece	779,31
LTUBE10610	TUB-ER 1601–1800*, made to measure manufactured in 2 parts, incl. 1 cartridge COL-MK	1601–1800 x 30/45 mm	piece	871,77
LTUBE10611	TUB-ER 1801–2000*, made to measure manufactured in 2 parts, incl. 1 cartridge COL-MK	1801–2000 x 30/45 mm	piece	911,40

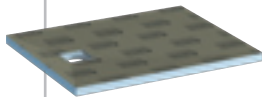

LUX ELEMENTS manufactures individual customised and special products for TUB. These include dimensions, thicknesses, shapes etc. that deviate from the standard programme. For more information see page 5.



Visit [www.luxelements.com](http://www.luxelements.com) for further information on TUB. Data sheets, assembly instructions, test certificates and additional brochures under 'Downloads', videos under 'Practice' and on YouTube.

■ **PRODUCT SPECIFICATIONS – LUX ELEMENTS®-TUB-MR**

Packaging specifications see p. 145 · Online calculator see p. 7 · \* standard-compliant according to DIN 18534

ARTICLE-NUMBER	ARTICLE-NAME / ARTICLE-DESCRIPTION	NOMINAL FORMATS/DIMENSIONS LENGTH x WIDTH x HEIGHT	UNIT	PRICE / UNIT €
----------------	------------------------------------	--	------	----------------

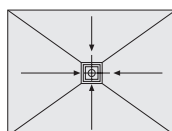

TUB-MR

**TUB-MR**, hard foam shower base elements, rectangular, integrated and sealed floor drain support frame 135 x 135 mm in the centre.  
→ Substrate elements see page 114–115 / Drainage technology and accessories see page 130–133

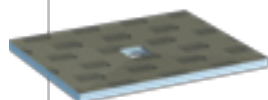

LTUBE10719	TUB-MR 900/800*, standard format	900 x 800 x 30/45 mm	piece	307,02
LTUBE10701	TUB-MR 1000/800*, standard format	1000 x 800 x 30/45 mm	piece	322,16
LTUBE10720	TUB-MR 1100/800*, standard format	1100 x 800 x 30/45 mm	piece	340,68
LTUBE10718	TUB-MR 1200/800*, standard format	1200 x 800 x 30/45 mm	piece	362,10
LTUBE10721	TUB-MR 1000/900*, standard format	1000 x 900 x 30/45 mm	piece	353,74
LTUBE10722	TUB-MR 1100/900*, standard format	1100 x 900 x 30/45 mm	piece	371,79
LTUBE10702	TUB-MR 1200/900*, standard format	1200 x 900 x 30/45 mm	piece	393,57
LTUBE10717	TUB-MR 1300/900*, standard format	1300 x 900 x 30/45 mm	piece	411,57
LTUBE10704	TUB-MR 1400/900*, standard format	1400 x 900 x 30/45 mm	piece	429,43
LTUBE10705	TUB-MR 1500/900*, standard format	1500 x 900 x 30/45 mm	piece	444,41
LTUBE10706	TUB-MR 1600/900*, standard format	1600 x 900 x 30/45 mm	piece	458,30
LTUBE10723	TUB-MR 1100/1000*, standard format	1100 x 1000 x 30/45 mm	piece	403,01
LTUBE10703	TUB-MR 1200/1000*, standard format	1200 x 1000 x 30/45 mm	piece	424,76
LTUBE10724	TUB-MR 1300/1000*, standard format	1300 x 1000 x 30/45 mm	piece	462,71
LTUBE10725	TUB-MR 1400/1000*, standard format	1400 x 1000 x 30/45 mm	piece	481,53
LTUBE10726	TUB-MR 1500/1000*, standard format	1500 x 1000 x 30/45 mm	piece	497,19
LTUBE10727	TUB-MR 1600/1000*, standard format	1600 x 1000 x 30/45 mm	piece	511,85
LTUBE10707	TUB-MR 1–1000*, made to measure	1–1000 x 30/45 mm	piece	419,37
LTUBE10708	TUB-MR 1001–1200*, made to measure	1001–1200 x 30/45 mm	piece	476,84
LTUBE10709	TUB-MR 1201–1400*, made to measure	1201–1400 x 30/45 mm	piece	579,87
LTUBE10710	TUB-MR 1401–1600*, made to measure	1401–1600 x 30/45 mm	piece	779,31
LTUBE10711	TUB-MR 1601–1800*, made to measure, manufactured in 2 parts, incl. 1 cartridge COL-MK	1601–1800 x 30/45 mm	piece	871,77
LTUBE10712	TUB-MR 1801–2000*, made to measure, manufactured in 2 parts, incl. 1 cartridge COL-MK	1801–2000 x 30/45 mm	piece	911,40



LUX ELEMENTS manufactures individual customised and special products for TUB. These include dimensions, thicknesses, shapes etc. that deviate from the standard programme. For more information see page 5.



Visit [www.luxelements.com](http://www.luxelements.com) for further information on TUB. Data sheets, assembly instructions, test certificates and additional brochures under 'Downloads', videos under 'Practice' and on YouTube.



Flush with the floor shower bases with separate drainage technology for the substitution of bath tubs

### TUB-BOL

- Factory sealing
- Sealed floor drain fitting frame
- Prefabricated gradient (four-sided)
- Can be shortened in length through area without gradient
- Shower base height: 30/45 mm
- For barrier-free construction
- Second drainage level
- Matching substrate elements with a height of 55 mm, see page 114
- Secure click system for fastening the drain connection fitting
- Suitable drain systems, see page 130–133

Also available with floor channel drain, see TUB-LINE BOL, page 106

#### Accessories (optional)

- Matching benches RELAX-BA from page 46



- Shower base, can be cut to size

TUB-BOL 1800/800 – can be cut to size to minimum 800 x 1200 mm

TUB-BOL 1800/900 – can be cut to size to minimum 900 x 1200 mm

TUB-BOL 1800/1000 – can be cut to size to minimum 1000 x 1200 mm

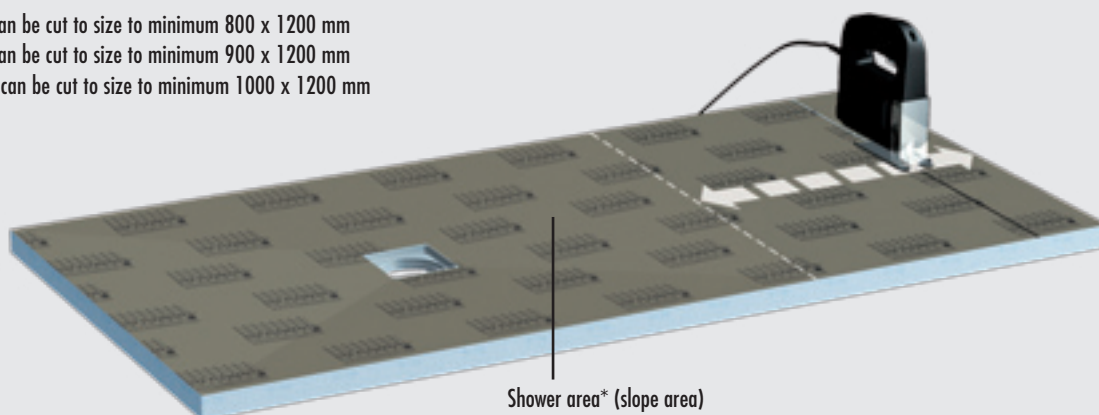

Shower area\* (slope area)

\*Please note: the fittings are to be located in the shower area



## SYSTEMS ON UNFINISHED FLOORS – SHOWERS POINT DRAINAGE / SEPARATE DRAINAGE TECHNOLOGY

■ **PRODUCT SPECIFICATIONS – LUX ELEMENTS®-TUB-BOL** Packaging specifications see p. 146 · Online calculator see p. 7 · \* standard-compliant according to DIN 18534

ARTICLE-NUMBER	ARTICLE-NAME / ARTICLE-DESCRIPTION	NOMINAL FORMATS/DIMENSIONS LENGTH x WIDTH x HEIGHT	UNIT	PRICE / UNIT €
----------------	------------------------------------	--	------	----------------

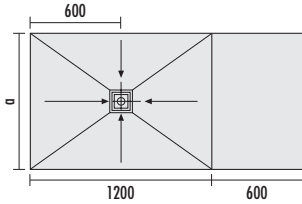

**TUB-BOL 1800/800: a = 800**  
**TUB-BOL 1800/900: a = 900**  
**TUB-BOL 1800/1000: a = 1000**

	<p><b>TUB-BOL</b>, hard foam shower base elements for the substitution of bath tubs, with integrated and sealed floor drain support frame 135 x 135 mm, can be cut to length, drain in the slope area in the centre.  <b>→ Substrate elements see page 114–115 / Drainage technology and accessories see page 130–133</b></p>				
	<b>LTUBE18026</b>	<b>TUB-BOL 1800/800*</b> , can be cut to length to minimum 800 x 1200 mm, slope area from 800 x 1200 mm	1800 x 800 x 30/45 mm	piece	479,55
	<b>LTUBE18018</b>	<b>TUB-BOL 1800/900*</b> , can be cut to length to minimum 900 x 1200 mm, slope area from 900 x 1200 mm	1800 x 900 x 30/45 mm	piece	499,48
	<b>LTUBE18027</b>	<b>TUB-BOL 1800/1000*</b> , can be cut to length to minimum 1000 x 1200 mm, slope area from 1000 x 1200 mm	1800 x 1000 x 30/45 mm	piece	532,15



LUX ELEMENTS manufactures individual customised and special products for TUB. These include dimensions, thicknesses, shapes etc. that deviate from the standard programme. For more information see page 5.



Visit [www.luxelements.com](http://www.luxelements.com) for further information on TUB. Data sheets, assembly instructions, test certificates and additional brochures under 'Downloads', videos under 'Practice' and on YouTube.



Flush with the floor shower bases with separate drainage technology including surface element

**TUB-FINISH**

- Set of shower base and surface element made of white solid surface material including design grate made of solid surface material
- Ready to adhere – without time-consuming cutting to size
- Sealed floor drain fitting frame
- Factory sealing
- Prefabricated gradient (four-sided)
- Excellent hygienic properties of the surface
- Pore-free, heat-resistant surface
- Simple maintenance and care
- Durable and hard-wearing
- Shower base height: 30/45 mm
- Surface element height: 6 mm
- For barrier-free construction
- Second drainage level
- Matching substrate elements with a height of 55 mm, see page 114
- Secure click system for fastening the drain connection fitting
- Suitable drain systems, see page 130–133

Also available with floor channel drain, see TUB-LINE FINISH page 112

Adhesion with mounting adhesive COL-MK (see p. 22), consumption of COL-MK:

- Shower bases 900 x 900 mm = 1 cartridge,
- Shower bases 1200 x 900 mm = 2 cartridges,
- Shower bases 1600 x 900 mm = 3 cartridges

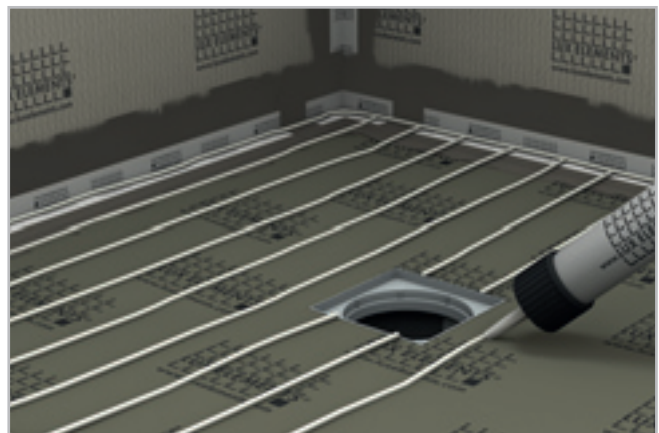

■ Installation height (e.g. floor drain support horizontal with substrate element)

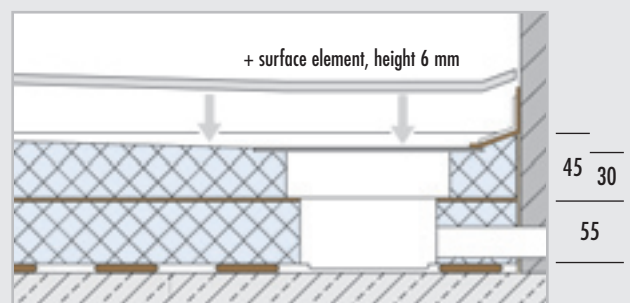

**Please note:** Dimensions in mm. Measures without adhesive coating and surface element.



## SYSTEMS ON UNFINISHED FLOORS – SHOWERS POINT DRAINAGE / SEPARATE DRAINAGE TECHNOLOGY

### ■ PRODUCT SPECIFICATIONS – LUX ELEMENTS®-TUB-FINISH

Packaging specifications see p. 133 · Online calculator see p. 7 · \* standard-compliant according to DIN 18534

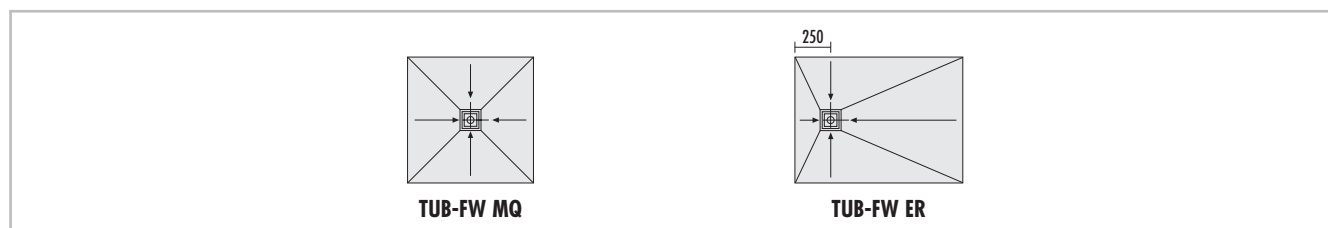
ARTICLE-NUMBER	ARTICLE-NAME / ARTICLE-DESCRIPTION	NOMINAL FORMATS/DIMENSIONS LENGTH x WIDTH x HEIGHT	UNIT	PRICE / UNIT €
----------------	------------------------------------	---	------	----------------

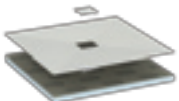
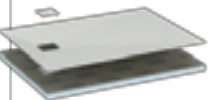

<b>TUB-FW</b> , hard foam shower base elements, with built-in and sealed floor drain fitting frame 135 x 135 mm, with surface element FW (d=6 mm) and design grate FW (d=6 mm) made of white solid surface material. <b>→ Substrate elements see page 114–115 / Drainage technology and accessories see page 130–133</b>				
	<b>LTUBE10101.FW</b>	<b>TUB-FW MQ 900*</b> , square, drain in the centre	shower base element: 900 x 900 x 30/45 mm, surface element: 900 x 900 x 6 mm	set  728,92
	<b>LTUBE10601.FW</b>	<b>TUB-FW ER 1200/900*</b> , rectangular, drain off-centre	shower base element: 1200 x 900 x 30/45 mm, surface element: 1200 x 900 x 6 mm	set  782,42
	<b>LTUBE10605.FW</b>	<b>TUB-FW ER 1600/900*</b> , rectangular, drain off-centre	shower base element: 1600 x 900 x 30/45 mm, surface element: 1600 x 900 x 6 mm	set  937,46



LUX ELEMENTS manufactures individual customised and special products for TUB.

These include dimensions, thicknesses, shapes etc. that deviate from the standard programme. For more information see page 5.



Visit [www.luxelements.com](http://www.luxelements.com) for further information on TUB.

Data sheets, assembly instructions, test certificates and additional brochures under 'Downloads', videos under 'Practice' and on YouTube.



Flush with the floor shower bases with separate drainage technology with sealed floor channel drain

**TUB-LINE**

- Shower base element with integrated and sealed floor channel drain (70 x 650 mm, 70 x 750 mm or 70 x 850 mm)
- Factory sealing
- Prefabricated gradient (one-sided/four-sided)
- Shower base height: 30/45 mm
- Reversible channel cover rail offers two design options
- Clean tiling with tiling aid
- Height-adjustable for optimum adaptation to covering thickness
- For barrier-free construction
- Second drainage level
- Matching substrate elements with a height of 55 mm, see page 114
- Secure click system for fastening the drain connection fitting
- Suitable drain systems, see page 134

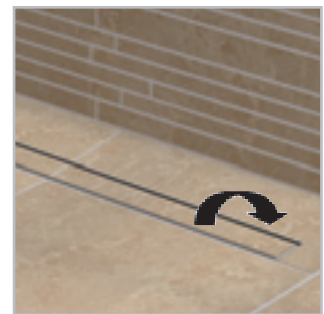

■ Installation heights

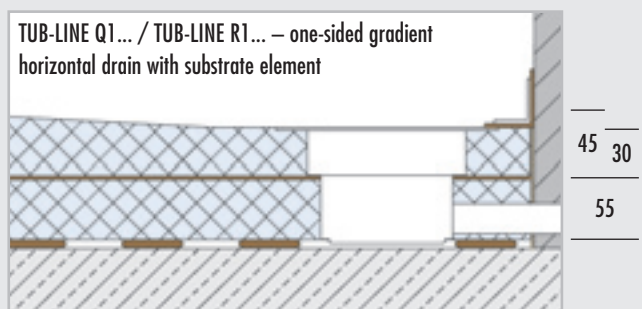
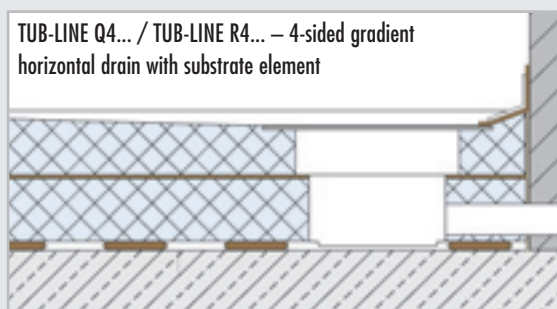
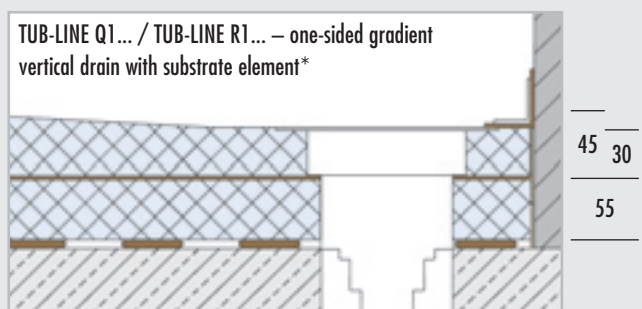
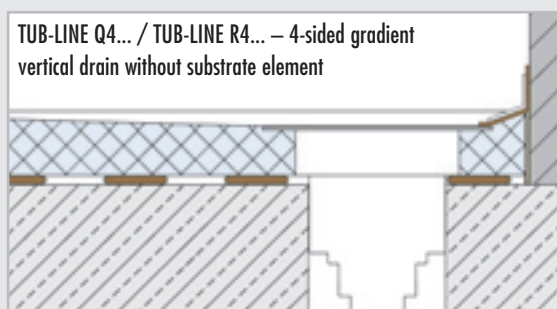

\* The overall height when installing the vertical drain without a substrate element is reduced by the height of the substrate element (= 55 mm).

Please note: Dimensions in mm. Measures without adhesive coating and tiles. For further details, please see technical data sheet TUB-LINE.

## SYSTEMS ON UNFINISHED FLOORS – SHOWERS LINEAR DRAINAGE / SEPARATE DRAINAGE TECHNOLOGY

### ■ PRODUCT SPECIFICATIONS – LUX ELEMENTS®-TUB-LINE Q4 / Q1 Packaging specifications see p. 146 · Online calculator see p. 7 · \* standard-compliant according to DIN 18534

ARTICLE-NUMBER	ARTICLE-NAME / ARTICLE-DESCRIPTION	NOMINAL FORMATS/DIMENSIONS LENGTH x WIDTH x HEIGHT	UNIT	PRICE / UNIT €
----------------	------------------------------------	---	------	----------------

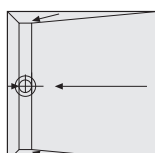

TUB-LINE Q4

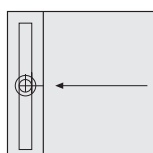

TUB-LINE Q1



Floor channel drain

	<b>TUB-LINE Q4</b> , hard foam shower base elements, square, with 4-sided gradient, with integrated and sealed floor channel drain, with cover rail and tiling aid made of brushed stainless steel, cover rail tileable on the rear side, with odour trap, height adjustable with height adapter from 5–17 mm. → <b>Substrate elements see page 114–115 / Drainage technology and accessories see page 134</b>				
	<b>with floor channel drain 70 x 650 mm</b>				
	LTUBE94033	TUB-LINE Q4 800*, standard format	800 x 800 x 30/45 mm	piece	792,96
	LTUBE94035	TUB-LINE Q4 800-900*, made to measure	800–900 x 800–900 x 30/45 mm	piece	838,88
	<b>with floor channel drain 70 x 750 mm</b>				
	LTUBE94001	TUB-LINE Q4 900*, standard format	900 x 900 x 30/45 mm	piece	830,64
	LTUBE94009	TUB-LINE Q4 900–1000*, made to measure	900–1000 x 900–1000 x 30/45 mm	piece	924,29
	<b>with floor channel drain 70 x 850 mm</b>				
	LTUBE94017	TUB-LINE Q4 1000*, standard format	1000 x 1000 x 30/45 mm	piece	903,02
	LTUBE94037	TUB-LINE Q4 1100*, standard format	1100 x 1100 x 30/45 mm	piece	931,71
	LTUBE94019	TUB-LINE Q4 1200*, standard format	1200 x 1200 x 30/45 mm	piece	960,42
	LTUBE94023	TUB-LINE Q4 1000–1200*, made to measure	1000–1200 x 1000–1200 x 30/45 mm	piece	1.008,21
		<b>TUB-LINE Q1</b> , hard foam shower base elements, square, with 1-sided gradient, with integrated and sealed floor channel drain, with cover rail and tiling aid made of brushed stainless steel, cover rail tileable on the rear side, with odour trap, height adjustable with height adapter from 5–17 mm. → <b>Substrate elements see page 114–115 / Drainage technology and accessories see page 134</b>			
<b>with floor channel drain 70 x 650 mm</b>					
LTUBE94034		TUB-LINE Q1 800*, standard format	800 x 800 x 30/45 mm	piece	785,52
LTUBE94036		TUB-LINE Q1 800-900*, made to measure	800–900 x 800–900 x 30/45 mm	piece	828,52
<b>with floor channel drain 70 x 750 mm</b>					
LTUBE94002		TUB-LINE Q1 900*, standard format	900 x 900 x 30/45 mm	piece	823,20
LTUBE94010		TUB-LINE Q1 870–1000*, made to measure	870–1000 x 900–1000 x 30/45 mm	piece	916,77
<b>with floor channel drain 70 x 850 mm</b>					
LTUBE94018		TUB-LINE Q1 1000*, standard format	1000 x 1000 x 30/45 mm	piece	895,60
LTUBE94038		TUB-LINE Q1 1100*, standard format	1100 x 1100 x 30/45 mm	piece	924,30
LTUBE94020		TUB-LINE Q1 1200*, standard format	1200 x 1200 x 30/45 mm	piece	953,01
LTUBE94024		TUB-LINE Q1 970–1200*, made to measure	970–1200 x 1000–1200 x 30/45 mm	piece	1.000,44



LUX ELEMENTS manufactures individual customised and special products for TUB. These include dimensions, thicknesses, shapes etc. that deviate from the standard programme. For more information see page 5.



Visit [www.luxelements.com](http://www.luxelements.com) for further information on TUB. Data sheets, assembly instructions, test certificates and additional brochures under 'Downloads', videos under 'Practice' and on YouTube.

■ **PRODUCT SPECIFICATIONS – LUX ELEMENTS®-TUB-LINE R4** Packaging specifications see p. 147 · Online calculator see p. 7 · \* standard-compliant according to DIN 18534

ARTICLE-NUMBER	ARTICLE-NAME / ARTICLE-DESCRIPTION	NOMINAL FORMATS/DIMENSIONS LENGTH x WIDTH x HEIGHT	UNIT	PRICE / UNIT €
----------------	------------------------------------	--	------	----------------

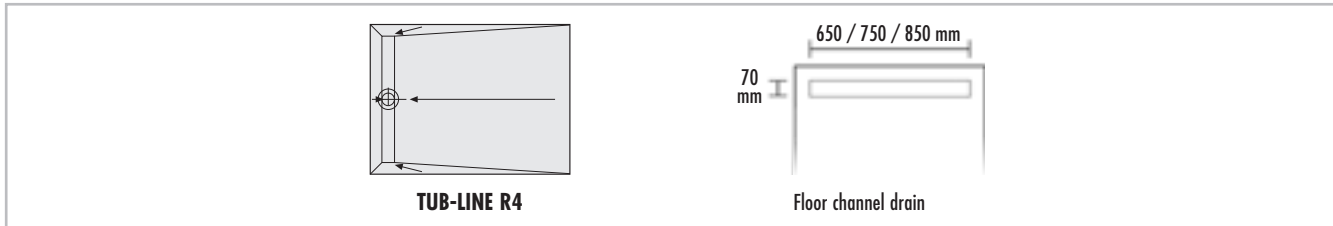

	<b>TUB-LINE R4</b> , hard foam shower base elements, rectangular, with 4-sided gradient, with integrated and sealed floor channel drain on shorter side, with cover rail and tiling aid made of brushed stainless steel, cover rail tileable on the rear side, with odour trap, height adjustable with height adapter from 5–17 mm. → <b>Substrate elements see page 114–115 / Drainage technology and accessories see page 134</b>				
	<b>with floor channel drain 70 x 650 mm</b>				
	LTUBE94039	TUB-LINE R4 900/800*, standard format	900 x 800 x 30/45 mm	piece	794,31
	LTUBE94041	TUB-LINE R4 1000/800*, standard format	1000 x 800 x 30/45 mm	piece	809,24
	LTUBE94043	TUB-LINE R4 1100/800*, standard format	1100 x 800 x 30/45 mm	piece	824,16
	LTUBE94045	TUB-LINE R4 1200/800*, standard format	1200 x 800 x 30/45 mm	piece	839,08
	<b>with floor channel drain 70 x 750 mm</b>				
	LTUBE94047	TUB-LINE R4 1000/900*, standard format	1000 x 900 x 30/45 mm	piece	829,28
	LTUBE94049	TUB-LINE R4 1100/900*, standard format	1100 x 900 x 30/45 mm	piece	851,09
	LTUBE94003	TUB-LINE R4 1200/900*, standard format	1200 x 900 x 30/45 mm	piece	872,94
	LTUBE94051	TUB-LINE R4 1300/900*, standard format	1300 x 900 x 30/45 mm	piece	899,32
	LTUBE94005	TUB-LINE R4 1400/900*, standard format	1400 x 900 x 30/45 mm	piece	925,68
	LTUBE94053	TUB-LINE R4 1500/900*, standard format	1500 x 900 x 30/45 mm	piece	939,28
	LTUBE94007	TUB-LINE R4 1600/900*, standard format	1600 x 900 x 30/45 mm	piece	952,87
	<b>with floor channel drain 70 x 850 mm</b>				
	LTUBE94055	TUB-LINE R4 1100/1000*, standard format	1100 x 1000 x 30/45 mm	piece	915,04
	LTUBE94021	TUB-LINE R4 1200/1000*, standard format	1200 x 1000 x 30/45 mm	piece	933,24
	LTUBE94057	TUB-LINE R4 1300/1000*, standard format	1300 x 1000 x 30/45 mm	piece	962,18
	LTUBE94059	TUB-LINE R4 1400/1000*, standard format	1400 x 1000 x 30/45 mm	piece	992,07
	LTUBE94061	TUB-LINE R4 1500/1000*, standard format	1500 x 1000 x 30/45 mm	piece	1.012,30
LTUBE94063	TUB-LINE R4 1600/1000*, standard format	1600 x 1000 x 30/45 mm	piece	1.027,76	



LUX ELEMENTS manufactures individual customised and special products for TUB. These include dimensions, thicknesses, shapes etc. that deviate from the standard programme. For more information see page 5.



Visit [www.luxelements.com](http://www.luxelements.com) for further information on TUB. Data sheets, assembly instructions, test certificates and additional brochures under 'Downloads', videos under 'Practice' and on YouTube.

## SYSTEMS ON UNFINISHED FLOORS – SHOWERS

### LINEAR DRAINAGE / SEPARATE DRAINAGE TECHNOLOGY

■ **PRODUCT SPECIFICATIONS – LUX ELEMENTS®-TUB-LINE R4** Packaging specifications on request · Online calculator see p. 7 · \* standard-compliant according to DIN 18534

ARTICLE-NUMBER	ARTICLE-NAME / ARTICLE-DESCRIPTION	NOMINAL FORMATS/DIMENSIONS LENGTH x WIDTH x HEIGHT	UNIT	PRICE / UNIT €
----------------	------------------------------------	--	------	----------------

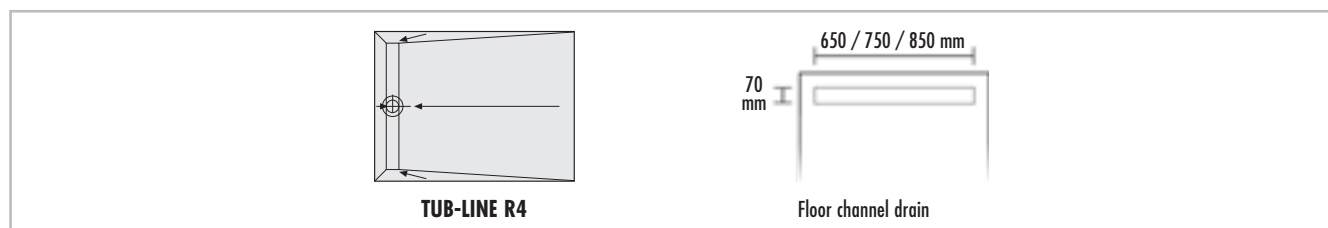

TUB-LINE R4

Floor channel drain

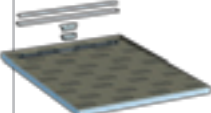
	<b>TUB-LINE R4</b> , hard foam shower base elements, rectangular, with 4-sided gradient, with integrated and sealed floor channel drain on shorter side, with cover rail and tiling aid made of brushed stainless steel, cover rail tileable on the rear side, with odour trap, height adjustable with height adapter from 5–17 mm. → <b>Substrate elements see page 114–115 / Drainage technology and accessories see page 134</b>				
	<b>with floor channel drain 70 x 650 mm</b>				
	LTUBE94065	TUB-LINE R4 900–1200/800–900*, made to measure	900–1200 x 800–900 x 30/45 mm	piece	924,63
	<b>with floor channel drain 70 x 750 mm</b>				
	LTUBE94011	TUB-LINE R4 1000–1200/900–1000*, made to measure	1000–1200 x 900–1000 x 30/45 mm	piece	955,36
	LTUBE94013	TUB-LINE R4 1200–1400/900–1000*, made to measure	1200–1400 x 900–1000 x 30/45 mm	piece	1.048,49
	LTUBE94015	TUB-LINE R4 1400–1600/900–1000*, made to measure	1400–1600 x 900–1000 x 30/45 mm	piece	1.083,69
	<b>with floor channel drain 70 x 850 mm</b>				
	LTUBE94025	TUB-LINE R4 1000–1200/1000–1100*, made to measure	1000–1200 x 1000–1100 x 30/45 mm	piece	1.001,98
	LTUBE94067	TUB-LINE R4 1200–1400/1000–1100*, made to measure	1200–1400 x 1000–1100 x 30/45 mm	piece	1.153,69
LTUBE94069	TUB-LINE R4 1400–1600/1000–1100*, made to measure	1400–1600 x 1000–1100 x 30/45 mm	piece	1.181,70	



LUX ELEMENTS manufactures individual customised and special products for TUB.

These include dimensions, thicknesses, shapes etc. that deviate from the standard programme. For more information see page 5.



Visit [www.luxelements.com](http://www.luxelements.com) for further information on TUB.

Data sheets, assembly instructions, test certificates and additional brochures under 'Downloads', videos under 'Practice' and on YouTube.

■ **PRODUCT SPECIFICATIONS – LUX ELEMENTS®-TUB-LINE R1** Packaging specifications see p. 147 · Online calculator see p. 7 · \* standard-compliant according to DIN 18534

ARTICLE-NUMBER	ARTICLE-NAME / ARTICLE-DESCRIPTION	NOMINAL FORMATS/DIMENSIONS LENGTH x WIDTH x HEIGHT	UNIT	PRICE / UNIT €
----------------	------------------------------------	--	------	----------------

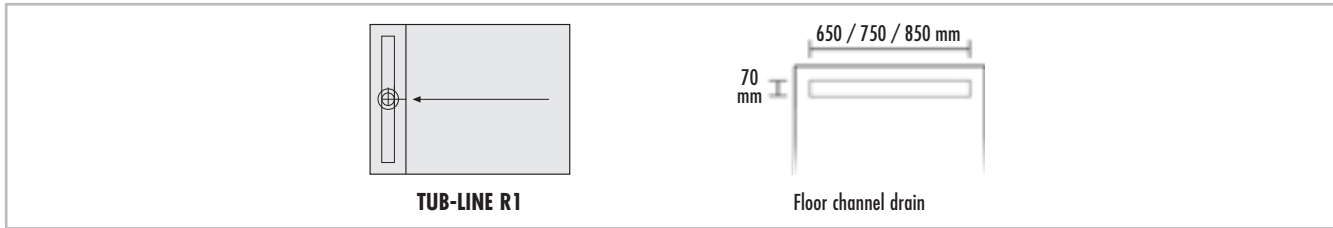

	<b>TUB-LINE R1</b> , hard foam shower base elements, rectangular, with 1-sided gradient, with integrated and sealed floor channel drain on shorter side, with cover rail and tiling aid made of brushed stainless steel, cover rail tileable on the rear side, with odour trap, height adjustable with height adapter from 5–17 mm. → <b>Substrate elements see page 114–115 / Drainage technology and accessories see page 134</b>			
	<b>with floor channel drain 70 x 650 mm</b>			
	LTUBE94040	TUB-LINE R1 900/800*, standard format	900 x 800 x 30/45 mm	piece 786,85
	LTUBE94042	TUB-LINE R1 1000/800*, standard format	1000 x 800 x 30/45 mm	piece 802,95
	LTUBE94044	TUB-LINE R1 1100/800*, standard format	1100 x 800 x 30/45 mm	piece 816,91
	LTUBE94046	TUB-LINE R1 1200/800*, standard format	1200 x 800 x 30/45 mm	piece 831,51
	<b>with floor channel drain 70 x 750 mm</b>			
	LTUBE94048	TUB-LINE R1 1000/900*, standard format	1000 x 900 x 30/45 mm	piece 822,03
	LTUBE94050	TUB-LINE R1 1100/900*, standard format	1100 x 900 x 30/45 mm	piece 843,56
	LTUBE94004	TUB-LINE R1 1200/900*, standard format	1200 x 900 x 30/45 mm	piece 865,35
	LTUBE94052	TUB-LINE R1 1300/900*, standard format	1300 x 900 x 30/45 mm	piece 891,84
	LTUBE94006	TUB-LINE R1 1400/900*, standard format	1400 x 900 x 30/45 mm	piece 918,13
	LTUBE94054	TUB-LINE R1 1500/900*, standard format	1500 x 900 x 30/45 mm	piece 931,71
	LTUBE94008	TUB-LINE R1 1600/900*, standard format	1600 x 900 x 30/45 mm	piece 945,33
	<b>with floor channel drain 70 x 850 mm</b>			
	LTUBE94056	TUB-LINE R1 1100/1000*, standard format	1100 x 1000 x 30/45 mm	piece 907,58
	LTUBE94022	TUB-LINE R1 1200/1000*, standard format	1200 x 1000 x 30/45 mm	piece 925,69
	LTUBE94058	TUB-LINE R1 1300/1000*, standard format	1300 x 1000 x 30/45 mm	piece 954,72
	LTUBE94060	TUB-LINE R1 1400/1000*, standard format	1400 x 1000 x 30/45 mm	piece 984,62
	LTUBE94062	TUB-LINE R1 1500/1000*, standard format	1500 x 1000 x 30/45 mm	piece 1.004,86
LTUBE94064	TUB-LINE R1 1600/1000*, standard format	1600 x 1000 x 30/45 mm	piece 1.020,30	



LUX ELEMENTS manufactures individual customised and special products for TUB. These include dimensions, thicknesses, shapes etc. that deviate from the standard programme. For more information see page 5.



Visit [www.luxelements.com](http://www.luxelements.com) for further information on TUB. Data sheets, assembly instructions, test certificates and additional brochures under 'Downloads', videos under 'Practice' and on YouTube.



## SYSTEMS ON UNFINISHED FLOORS – SHOWERS LINEAR DRAINAGE / SEPARATE DRAINAGE TECHNOLOGY

### ■ PRODUCT SPECIFICATIONS – LUX ELEMENTS®-TUB-LINE R1 Packaging specifications on request · Online calculator see p. 7 · \* standard-compliant according to DIN 18534

ARTICLE-NUMBER	ARTICLE-NAME / ARTICLE-DESCRIPTION	NOMINAL FORMATS/DIMENSIONS LENGTH x WIDTH x HEIGHT	UNIT	PRICE / UNIT €
----------------	------------------------------------	--	------	----------------

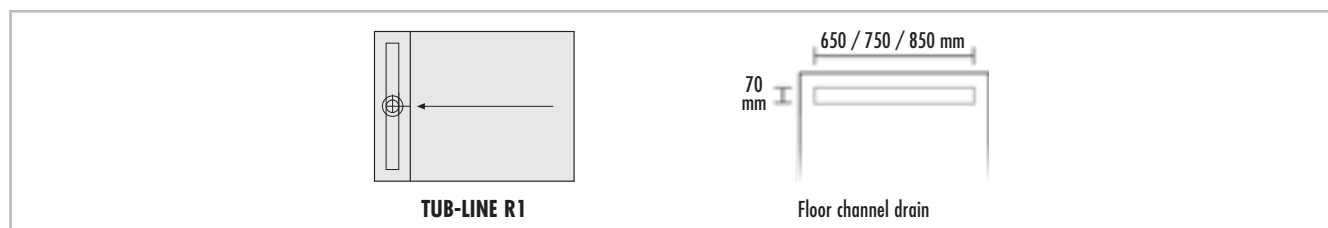

	<b>TUB-LINE R1</b> , hard foam shower base elements, rectangular, with 1-sided gradient, with integrated and sealed floor channel drain on shorter side, with cover rail and tiling aid made of brushed stainless steel, cover rail tileable on the rear side, with odour trap, height adjustable with height adapter from 5–17 mm. → <b>Substrate elements see page 114–115 / Drainage technology and accessories see page 134</b>				
	<b>with floor channel drain 70 x 650 mm</b>				
	LTUBE94066	TUB-LINE R1 900–1200/770–900*, made to measure	900–1200 x 770–900 x 30/45 mm	piece	916,62
	<b>with floor channel drain 70 x 750 mm</b>				
	LTUBE94012	TUB-LINE R1 1000–1200/870–1000*, made to measure	1000–1200 x 870–1000 x 30/45 mm	piece	947,61
	LTUBE94014	TUB-LINE R1 1200–1400/870–1000*, made to measure	1200–1400 x 870–1000 x 30/45 mm	piece	1.040,84
	LTUBE94016	TUB-LINE R1 1400–1600/870–1000*, made to measure	1400–1600 x 870–1000 x 30/45 mm	piece	1.074,90
	<b>with floor channel drain 70 x 850 mm</b>				
	LTUBE94026	TUB-LINE R1 1000–1200/970–1100*, made to measure	1000–1200 x 970–1100 x 30/45 mm	piece	994,22
	LTUBE94068	TUB-LINE R1 1200–1400/970–1100*, made to measure	1200–1400 x 970–1100 x 30/45 mm	piece	1.137,51
LTUBE94070	TUB-LINE R1 1400–1600/970–1100*, made to measure	1400–1600 x 970–1100 x 30/45 mm	piece	1.160,16	



LUX ELEMENTS manufactures individual customised and special products for TUB.

These include dimensions, thicknesses, shapes etc. that deviate from the standard programme. For more information see page 5.



Visit [www.luxelements.com](http://www.luxelements.com) for further information on TUB.

Data sheets, assembly instructions, test certificates and additional brochures under 'Downloads', videos under 'Practice' and on YouTube.



Flush with the floor shower bases with separate drainage technology for the substitution of bath tubs

### TUB-LINE BOL

- Shower base element with integrated and sealed floor channel drain (70 x 650 mm, 70 x 750 mm or 70 x 850 mm)
- Reversible channel cover rail offers two design options
- Factory sealing
- Prefabricated gradient (four-sided)
- Shower base height: 30/45 mm
- Clean tiling with tiling aid
- Height-adjustable for optimum adaptation to covering thickness
- Can be shortened in length through area without gradient
- For barrier-free construction
- Second drainage level
- Matching substrate elements with a height of 55 mm, see page 114
- Secure click system for fastening the drain connection fitting
- Suitable drain systems, see page 134
- Also available with extended cover rail, see page 110

Also available with point drainage, see TUB-BOL, page 96

#### Accessories (optional)

- Matching benches RELAX-BA from page 46

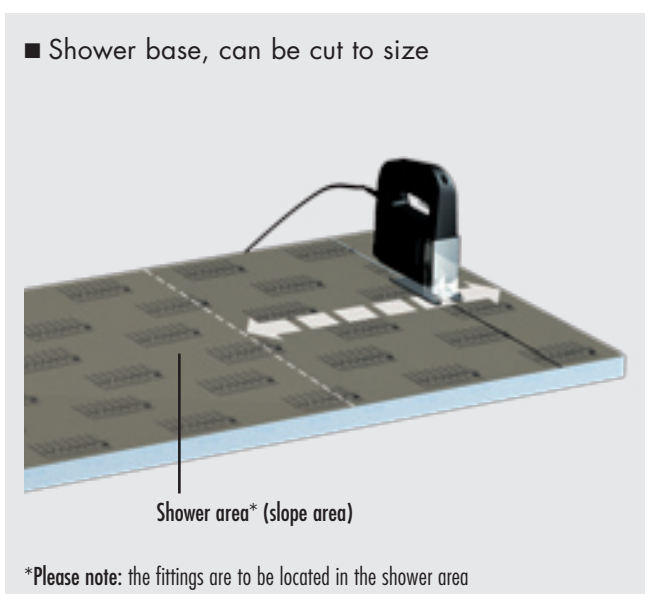

## SYSTEMS ON UNFINISHED FLOORS – SHOWERS LINEAR DRAINAGE / SEPARATE DRAINAGE TECHNOLOGY

### ■ PRODUCT SPECIFICATIONS – LUX ELEMENTS®-TUB-LINE BOL

Packaging specifications see p. 148 · Online calculator see p. 7 · \* standard-compliant according to DIN 18534

ARTICLE-NUMBER	ARTICLE-NAME / ARTICLE-DESCRIPTION	NOMINAL FORMATS/DIMENSIONS LENGTH x WIDTH x HEIGHT	UNIT	PRICE / UNIT €
----------------	------------------------------------	--	------	----------------

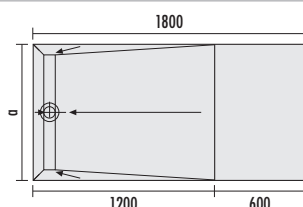

**TUB-LINE BOL 1800/800: a = 800**  
**TUB-LINE BOL 1800/900: a = 900**  
**TUB-LINE BOL 1800/1000: a = 1000**

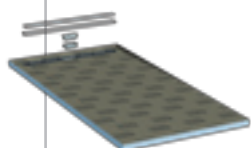

**TUB-LINE BOL**, hard foam shower base elements for the substitution of bath tubs, with 4-sided gradient, with integrated and sealed floor channel drain on shorter side, with cover rail and tiling aid made of brushed stainless steel, cover rail tileable on the rear side, with odour trap, height adjustable with height adapter from 5–17 mm. → **Substrate elements see p. 114–115 / Drainage technology and accessories see p. 134**

**with floor channel drain 70 x 650 mm**

<b>LTUBE97003</b>	<b>TUB-LINE BOL 1800/800*</b> , can be cut to length to minimum 800 x 1200 mm, slope area from 800 x 1200 mm	1800 x 800 x 30/45 mm	piece	949,72
-------------------	--	-----------------------	-------	--------

**with floor channel drain 70 x 750 mm**

<b>LTUBE97001</b>	<b>TUB-LINE BOL 1800/900*</b> , can be cut to length to minimum 900 x 1200 mm, slope area from 900 x 1200 mm	1800 x 900 x 30/45 mm	piece	986,11
-------------------	--	-----------------------	-------	--------

**with floor channel drain 70 x 850 mm**

<b>LTUBE97005</b>	<b>TUB-LINE BOL 1800/1000*</b> , can be cut to length to minimum 1000 x 1200 mm, slope area from 1000 x 1200 mm	1800 x 1000 x 30/45 mm	piece	1.008,46
-------------------	---	------------------------	-------	----------



LUX ELEMENTS manufactures individual customised and special products for TUB.

These include dimensions, thicknesses, shapes etc. that deviate from the standard programme. For more information see page 5.



Visit [www.luxelements.com](http://www.luxelements.com) for further information on TUB.

Data sheets, assembly instructions, test certificates and additional brochures under 'Downloads', videos under 'Practice' and on YouTube.



Flush with the floor shower bases  
 with separate drainage technology  
 with extended cover rail

**TUB-LINE V**

- Shower base element with integrated and sealed floor channel drain
- With extended cover rail (non-reversible) and extended tiling aid made of brushed stainless steel for continuous wall-to-wall channel look
- Can be shortened to fit the shower area
- Factory sealing
- Prefabricated gradient (one-sided)
- Shower base height: 30/45 mm
- Height-adjustable for optimum adaptation to covering thickness
- For barrier-free construction
- Second drainage level
- Matching substrate elements with a height of 55 mm, see page 114
- Secure click system for fastening the drain connection fitting
- Suitable drain systems, see page 134

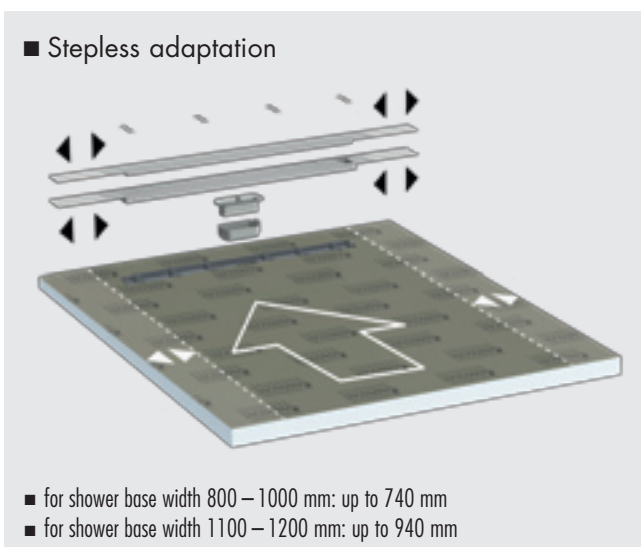
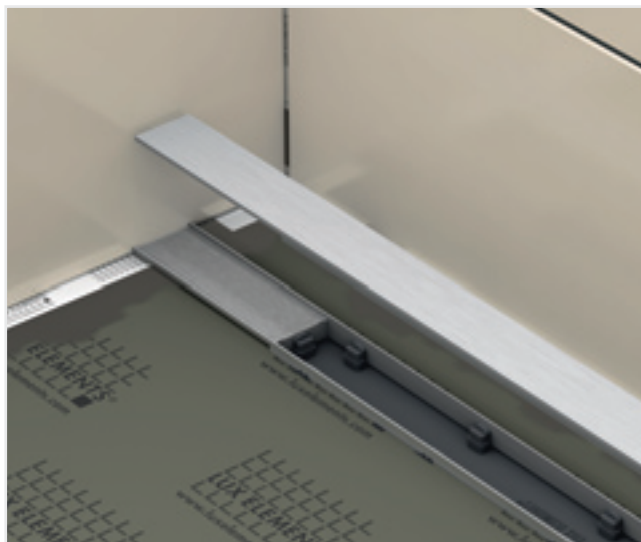

## SYSTEMS ON UNFINISHED FLOORS – SHOWERS LINEAR DRAINAGE / SEPARATE DRAINAGE TECHNOLOGY

### ■ PRODUCT SPECIFICATIONS – LUX ELEMENTS®-TUB-LINE V

Packaging specifications see p. 148 · Online calculator see p. 7 · \* standard-compliant according to DIN 18534

ARTICLE-NUMBER	ARTICLE-NAME / ARTICLE-DESCRIPTION	NOMINAL FORMATS/DIMENSIONS LENGTH x WIDTH x HEIGHT	UNIT	PRICE / UNIT €
----------------	------------------------------------	--	------	----------------

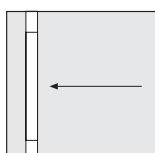

TUB-LINE V Q1

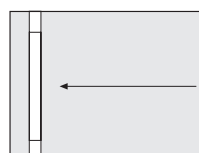

TUB-LINE V R1

**TUB-LINE V**, hard foam shower base elements with integrated and sealed floor channel drain (rectangular: on shorter side), with one-sided gradient, with extended tiling aid V and extended cover rail V over the shower base width in brushed stainless steel, with odour trap, height adjustable with height adapter from 5–17 mm. Shower base can be cut to size. Including accessories for the stepless adaptation of the stainless steel components → **Substrate elements see page 114–115 / Drainage technology and accessories see page 134**

	<b>LTUBE98010</b>	<b>TUB-LINE V Q1 800*</b> , square	800 x 800 x 30/45 mm	piece	817,18
	<b>LTUBE98011</b>	<b>TUB-LINE V Q1 900*</b> , square	900 x 900 x 30/45 mm	piece	854,86
	<b>LTUBE98012</b>	<b>TUB-LINE V Q1 1000*</b> , square	1000 x 1000 x 30/45 mm	piece	927,25
	<b>LTUBE98013</b>	<b>TUB-LINE V Q1 1100*</b> , square	1100 x 1100 x 30/45 mm	piece	955,96
	<b>LTUBE98014</b>	<b>TUB-LINE V Q1 1200*</b> , square	1200 x 1200 x 30/45 mm	piece	984,66
	<b>LTUBE98015</b>	<b>TUB-LINE V R1 900/800*</b> , rectangular	900 x 800 x 30/45 mm	piece	818,51
	<b>LTUBE98016</b>	<b>TUB-LINE V R1 1000/800*</b> , rectangular	1000 x 800 x 30/45 mm	piece	834,60
	<b>LTUBE98017</b>	<b>TUB-LINE V R1 1100/800*</b> , rectangular	1100 x 800 x 30/45 mm	piece	848,57
	<b>LTUBE98018</b>	<b>TUB-LINE V R1 1200/800*</b> , rectangular	1200 x 800 x 30/45 mm	piece	863,17
	<b>LTUBE98019</b>	<b>TUB-LINE V R1 1000/900*</b> , rectangular	1000 x 900 x 30/45 mm	piece	853,68
	<b>LTUBE98020</b>	<b>TUB-LINE V R1 1100/900*</b> , rectangular	1100 x 900 x 30/45 mm	piece	875,22
	<b>LTUBE98021</b>	<b>TUB-LINE V R1 1200/900*</b> , rectangular	1200 x 900 x 30/45 mm	piece	897,01
	<b>LTUBE98022</b>	<b>TUB-LINE V R1 1300/900*</b> , rectangular	1300 x 900 x 30/45 mm	piece	923,50
	<b>LTUBE98023</b>	<b>TUB-LINE V R1 1400/900*</b> , rectangular	1400 x 900 x 30/45 mm	piece	949,79
	<b>LTUBE98024</b>	<b>TUB-LINE V R1 1500/900*</b> , rectangular	1500 x 900 x 30/45 mm	piece	963,37
	<b>LTUBE98025</b>	<b>TUB-LINE V R1 1600/900*</b> , rectangular	1600 x 900 x 30/45 mm	piece	976,99
	<b>LTUBE98026</b>	<b>TUB-LINE V R1 1100/1000*</b> , rectangular	1100 x 1000 x 30/45 mm	piece	939,23
	<b>LTUBE98027</b>	<b>TUB-LINE V R1 1200/1000*</b> , rectangular	1200 x 1000 x 30/45 mm	piece	957,34
	<b>LTUBE98028</b>	<b>TUB-LINE V R1 1300/1000*</b> , rectangular	1300 x 1000 x 30/45 mm	piece	995,78
	<b>LTUBE98029</b>	<b>TUB-LINE V R1 1400/1000*</b> , rectangular	1400 x 1000 x 30/45 mm	piece	1.026,00
	<b>LTUBE98030</b>	<b>TUB-LINE V R1 1500/1000*</b> , rectangular	1500 x 1000 x 30/45 mm	piece	1.045,61
	<b>LTUBE98031</b>	<b>TUB-LINE V R1 1600/1000*</b> , rectangular	1600 x 1000 x 30/45 mm	piece	1.062,02



LUX ELEMENTS manufactures individual customised and special products for TUB.

These include dimensions, thicknesses, shapes etc. that deviate from the standard programme. For more information see page 5.



Visit [www.luxelements.com](http://www.luxelements.com) for further information on TUB.

Data sheets, assembly instructions, test certificates and additional brochures under 'Downloads', videos under 'Practice' and on YouTube.



Flush with the floor shower bases with separate drainage technology with extended cover rail

### TUB-LINE BOL V

- Shower base element with integrated and sealed floor channel drain
- With extended cover rail (non-reversible) and extended tiling aid made of brushed stainless steel for continuous wall-to-wall channel look
- Can be shortened to fit the shower area
- Factory sealing
- Prefabricated gradient (one-sided)
- Shower base height: 30/45 mm
- Can be shortened in length through area without gradient
- Height-adjustable for optimum adaptation to covering thickness
- For barrier-free construction
- Second drainage level
- Matching substrate elements with a height of 55 mm, see page 114
- Secure click system for fastening the drain connection fitting
- Suitable drain systems, see page 134

#### Accessories (optional)

- Matching benches RELAX-BA from page 46

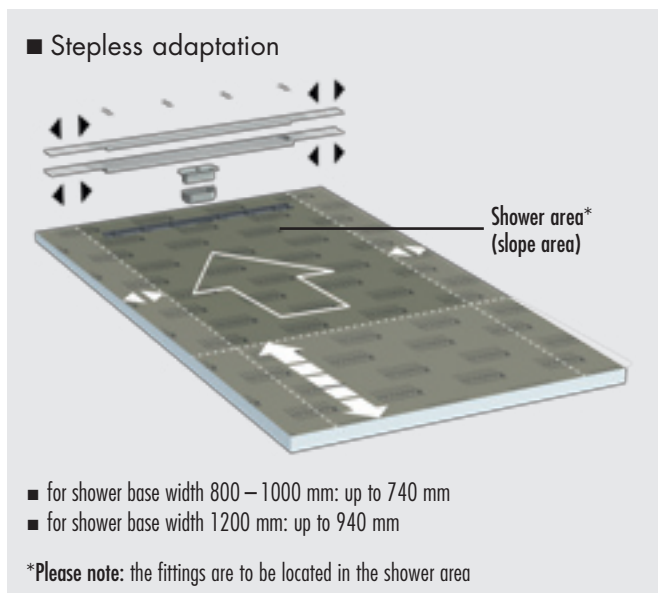
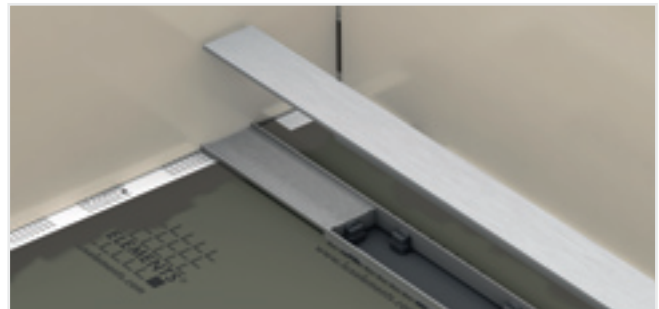
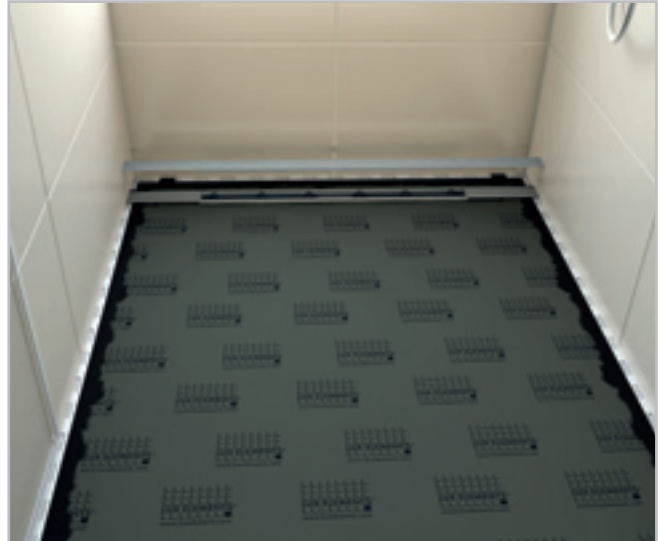

## SYSTEMS ON UNFINISHED FLOORS – SHOWERS LINEAR DRAINAGE / SEPARATE DRAINAGE TECHNOLOGY

■ **PRODUCT SPECIFICATIONS– LUX ELEMENTS®-TUB-LINE BOL V** Packaging specifications see p. 148 · Online calculator see p. 7 · \* standard-compliant according to DIN 18534

ARTICLE-NUMBER	ARTICLE-NAME / ARTICLE-DESCRIPTION	NOMINAL FORMATS/DIMENSIONS LENGTH x WIDTH x HEIGHT	UNIT	PRICE / UNIT €
----------------	------------------------------------	--	------	----------------

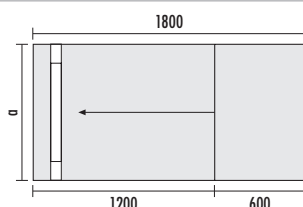

**TUB-LINE BOL V R1 1800/800: a = 800**  
**TUB-LINE BOL V R1 1800/900: a = 900**  
**TUB-LINE BOL V R1 1800/1000: a = 1000**  
**TUB-LINE BOL V R1 1800/1200: a = 1200**

	<p><b>TUB-LINE BOL V R1</b>, hard foam shower base elements, with one-sided gradient, with integrated and sealed floor channel drainage on shorter side, with extended tiling aid V and extended cover rail V over the shower base width in brushed stainless steel, with odour trap, height adjustable with height adapter from 5–17 mm. Shower base can be cut to size. Including accessories for the stepless adaptation of the stainless steel components.  <b>→ Substrate elements see page 114–115 / Drainage technology and accessories see page 134</b></p>			
	<b>LTUBE98003</b>	<b>TUB-LINE BOL V R1 1800/800*</b>	1800 x 800 x 30/45 mm	piece 991,09
	<b>LTUBE98004</b>	<b>TUB-LINE BOL V R1 1800/900*</b>	1800 x 900 x 30/45 mm	piece 1.027,83
	<b>LTUBE98001</b>	<b>TUB-LINE BOL V R1 1800/1000*</b>	1800 x 1000 x 30/45 mm	piece 1.063,44
	<b>LTUBE98002</b>	<b>TUB-LINE BOL V R1 1800/1200*</b>	1800 x 1200 x 30/45 mm	piece 1.110,00



LUX ELEMENTS manufactures individual customised and special products for TUB. These include dimensions, thicknesses, shapes etc. that deviate from the standard programme. For more information see page 5.



Visit [www.luxelements.com](http://www.luxelements.com) for further information on TUB. Data sheets, assembly instructions, test certificates and additional brochures under 'Downloads', videos under 'Practice' and on YouTube.



Flush with the floor shower bases with separate drainage technology including surface element

### TUB-LINE FINISH

- Set of shower base and surface element made of white solid surface material including cover rail made of solid surface material
- Ready to adhere – without time-consuming cutting to size
- Sealed floor drain fitting frame
- Factory sealing
- Prefabricated gradient (four-sided)
- Excellent hygienic properties of the surface
- Pore-free, heat-resistant surface
- Simple maintenance and care
- Durable and hard-wearing
- Shower base height: 30/45 mm
- Surface element height: 6 mm
- For barrier-free construction
- Second drainage level
- Matching substrate elements with a height of 55 mm, see page 114
- Secure click system for fastening the drain connection fitting
- Suitable drain systems, see page 134

Also available with point drainage, see TUB-FINISH page 98

Adhesion with mounting adhesive COL-MK (see p. 22), consumption of COL-MK:

- Shower bases 900 x 900 mm = 1 cartridge,
- Shower bases 1200 x 900 mm = 2 cartridges,
- Shower bases 1600 x 900 mm = 3 cartridges

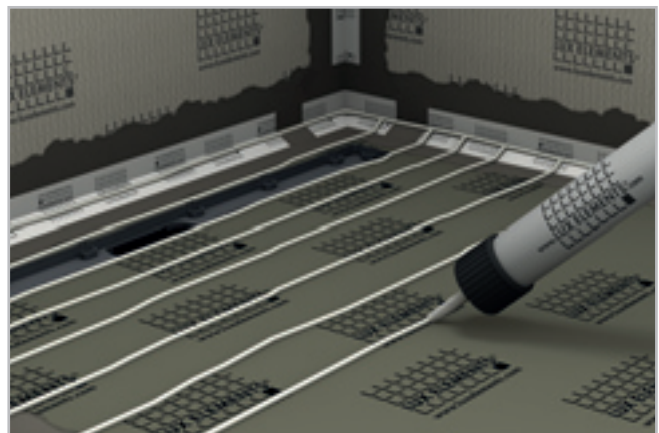

#### ■ Installation height (e.g. floor drain support horizontal with substrate element)

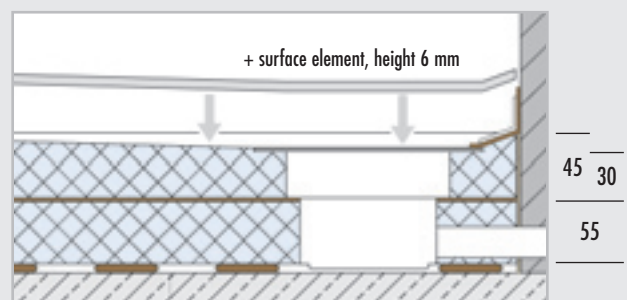

**Please note:** Dimensions in mm. Measures without adhesive coating and surface element.



## SYSTEMS ON UNFINISHED FLOORS – SHOWERS LINEAR DRAINAGE / SEPARATE DRAINAGE TECHNOLOGY

■ **PRODUCT SPECIFICATIONS – LUX ELEMENTS®-TUB-LINE FINISH** Packaging specifications see p. 149 · Online calculator see p. 7 · \* standard-compliant according to DIN 18534

ARTICLE-NUMBER	ARTICLE-NAME / ARTICLE-DESCRIPTION	NOMINAL FORMATS/DIMENSIONS LENGTH x WIDTH x HEIGHT	UNIT	PRICE / UNIT €
----------------	------------------------------------	--	------	----------------

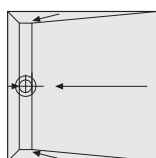

**TUB-LINE FW Q4**

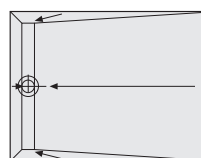

**TUB-LINE FW R4**

<b>TUB-LINE FW</b> , hard foam shower base elements, with 4-sided gradient, with integrated and sealed floor channel drain 70 x 750 mm on shorter side, with surface element FW (d=6 mm) and cover rail FW (d=12 mm) made of white solid surface material, with odour trap. <b>→ Substrate elements see page 114–115 / Drainage technology and accessories see page 134</b>				
	<b>LTUBE94001.FW</b>	<b>TUB-LINE FW Q4 900*</b> , square	shower base element: 900 x 900 x 30/45 mm, surface element: 900 x 900 x 6 mm	set 1.019,40
	<b>LTUBE94003.FW</b>	<b>TUB-LINE FW R4 1200/900*</b> , rectangular	shower base element: 1200 x 900 x 30/45 mm, surface element: 1200 x 900 x 6 mm	set 1.127,59
	<b>LTUBE94007.FW</b>	<b>TUB-LINE FW R4 1600/900*</b> , rectangular	shower base element: 1600 x 900 x 30/45 mm, surface element: 1600 x 900 x 6 mm	set 1.351,86



LUX ELEMENTS manufactures individual customised and special products for TUB.

These include dimensions, thicknesses, shapes etc. that deviate from the standard programme. For more information see page 5.



Visit [www.luxelements.com](http://www.luxelements.com) for further information on TUB.

Data sheets, assembly instructions, test certificates and additional brochures under 'Downloads', videos under 'Practice' and on YouTube.

## Substrate elements for TUB and TUB-LINE TUB-U

- **Universal substrate elements:**
  - For standard formats with shower bases
  - Simple shortening or cutting to size to other formats
  - including fillers for closing the unused openings
- **Made to measure substrate elements:**
  - For made to measure shower bases
  - including drain position cut to size

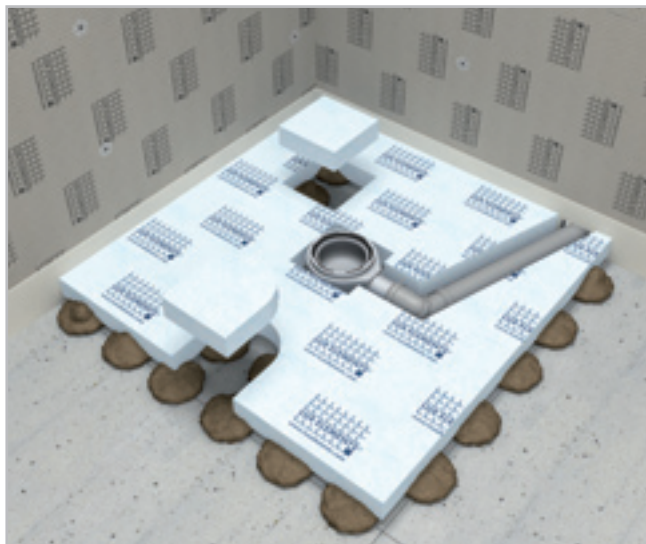

### ■ PRODUCT SPECIFICATIONS – LUX ELEMENTS®-TUB-U... (SUBSTRATE ELEMENTS)

Packaging specifications see p. 149 · Online calculator see p. 7

ARTICLE-NUMBER	ARTICLE-NAME / ARTICLE-DESCRIPTION	NOMINAL FORMATS/DIMENSIONS LENGTH x WIDTH x HEIGHT	UNIT	PRICE / UNIT €
----------------	------------------------------------	--	------	----------------

#### Universal substrate elements – for standard sizes TUB and TUB-LINE



	<b>LTUBE11110</b>	<b>TUB-UQ 800</b> , square	800 x 800 x 55 mm	piece	62,51
	<b>LTUBE11111</b>	<b>TUB-UQ 900</b> , square	900 x 900 x 55 mm	piece	66,76
	<b>LTUBE11112</b>	<b>TUB-UQ 1000</b> , square	1000 x 1000 x 55 mm	piece	101,00
	<b>LTUBE11115</b>	<b>TUB-UQ 1100</b> , square	1100 x 1100 x 55 mm	piece	110,49
	<b>LTUBE11113</b>	<b>TUB-UQ 1200</b> , square	1200 x 1200 x 55 mm	piece	114,61
	<b>LTUBE11114</b>	<b>TUB-UQ 1500</b> , square	1500 x 1500 x 55 mm	piece	200,48
	<b>LTUBE11828</b>	<b>TUB-UR 900/800</b> , rectangular	900 x 800 x 55 mm	piece	68,44
	<b>LTUBE11811</b>	<b>TUB-UR 1000/800</b> , rectangular	1000 x 800 x 55 mm	piece	74,06
	<b>LTUBE11819</b>	<b>TUB-UR 1100/800</b> , rectangular	1100 x 800 x 55 mm	piece	84,32
	<b>LTUBE11820</b>	<b>TUB-UR 1200/800</b> , rectangular	1200 x 800 x 55 mm	piece	86,98
	<b>LTUBE11821</b>	<b>TUB-UR 1000/900</b> , rectangular	1000 x 900 x 55 mm	piece	76,38
	<b>LTUBE11822</b>	<b>TUB-UR 1100/900</b> , rectangular	1100 x 900 x 55 mm	piece	84,80
	<b>LTUBE11812</b>	<b>TUB-UR 1200/900</b> , rectangular	1200 x 900 x 55 mm	piece	91,50
	<b>LTUBE11814</b>	<b>TUB-UR 1300/900</b> , rectangular	1300 x 900 x 55 mm	piece	113,95
	<b>LTUBE11815</b>	<b>TUB-UR 1400/900</b> , rectangular	1400 x 900 x 55 mm	piece	129,03
	<b>LTUBE11816</b>	<b>TUB-UR 1500/900</b> , rectangular	1500 x 900 x 55 mm	piece	129,72
	<b>LTUBE11817</b>	<b>TUB-UR 1600/900</b> , rectangular	1600 x 900 x 55 mm	piece	130,39
	<b>LTUBE11823</b>	<b>TUB-UR 1100/1000</b> , rectangular	1100 x 1000 x 55 mm	piece	99,19
	<b>LTUBE11813</b>	<b>TUB-UR 1200/1000</b> , rectangular	1200 x 1000 x 55 mm	piece	101,12
	<b>LTUBE11824</b>	<b>TUB-UR 1300/1000</b> , rectangular	1300 x 1000 x 55 mm	piece	168,36
	<b>LTUBE11825</b>	<b>TUB-UR 1400/1000</b> , rectangular	1400 x 1000 x 55 mm	piece	170,28
	<b>LTUBE11826</b>	<b>TUB-UR 1500/1000</b> , rectangular	1500 x 1000 x 55 mm	piece	172,20
	<b>LTUBE11827</b>	<b>TUB-UR 1600/1000</b> , rectangular	1600 x 1000 x 55 mm	piece	174,17

## SYSTEMS ON UNFINISHED FLOORS – SHOWERS

### POINT DRAINAGE + LINEAR DRAINAGE / SEPARATE DRAINAGE TECHNOLOGY

#### ■ PRODUCT SPECIFICATIONS – LUX ELEMENTS®-TUB-U... (SUBSTRATE ELEMENTS)

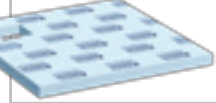
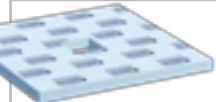
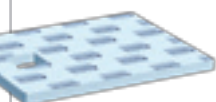
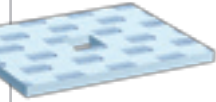
Packaging specifications see p. 149 · Online calculator see p. 7

ARTICLE-NUMBER	ARTICLE-NAME / ARTICLE-DESCRIPTION	NOMINAL FORMATS/DIMENSIONS LENGTH x WIDTH x HEIGHT	UNIT	PRICE / UNIT €
<b>Substrate elements for TUB-BOL and TUB-LINE BOL</b>				
	<b>LTUBE18028 TUB-UBOL 1800/800</b> , rectangular	1800 x 800 x 55 mm	piece	135,35
	<b>LTUBE18019 TUB-UBOL 1800/900</b> , rectangular	1800 x 900 x 55 mm	piece	135,35
	<b>LTUBE98101 TUB-UBOL 1800/1000</b> , rectangular	1800 x 1000 x 55 mm	piece	173,75
	<b>LTUBE98102 TUB-UBOL 1800/1200</b> , rectangular	1800 x 1200 x 55 mm	piece	199,48
<b>Substrate elements for TUB (point drainage) – made to measure</b>				
	<b>LTUBE11005 TUB-UEQ 1–1000</b> , square	1–1000 x 55 mm	piece	105,88
	<b>LTUBE11006 TUB-UEQ 1001–1200</b> , square	1001–1200 x 55 mm	piece	121,30
	<b>LTUBE11007 TUB-UEQ 1201–1400</b> , square	1201–1400 x 55 mm	piece	218,53
	<b>LTUBE11105 TUB-UMQ 1–1000</b> , square	1–1000 x 55 mm	piece	105,88
	<b>LTUBE11106 TUB-UMQ 1001–1200</b> , square	1001–1200 x 55 mm	piece	121,30
	<b>LTUBE11107 TUB-UMQ 1201–1400</b> , square	1201–1400 x 55 mm	piece	218,53
	<b>LTUBE11606 TUB-UER 1–1000</b> , rectangular	1–1000 x 55 mm	piece	105,88
	<b>LTUBE11607 TUB-UER 1001–1200</b> , rectangular	1001–1200 x 55 mm	piece	121,30
	<b>LTUBE11608 TUB-UER 1201–1400</b> , rectangular	1201–1400 x 55 mm	piece	211,89
	<b>LTUBE11609 TUB-UER 1401–1600</b> , rectangular	1401–1600 x 55 mm	piece	219,22
	<b>LTUBE11610 TUB-UER 1601–1800</b> , rectangular, manufactured in 2 parts	1601–1800 x 55 mm	piece	224,75
	<b>LTUBE11611 TUB-UER 1801–2000</b> , rectangular, manufactured in 2 parts	1801–2000 x 55 mm	piece	241,72
	<b>LTUBE11707 TUB-UMR 1–1000</b> , rectangular	1–1000 x 55 mm	piece	105,88
	<b>LTUBE11708 TUB-UMR 1001–1200</b> , rectangular	1001–1200 x 55 mm	piece	121,30
	<b>LTUBE11709 TUB-UMR 1201–1400</b> , rectangular	1201–1400 x 55 mm	piece	211,89
	<b>LTUBE11710 TUB-UMR 1401–1600</b> , rectangular	1401–1600 x 55 mm	piece	219,22
	<b>LTUBE11711 TUB-UMR 1601–1800</b> , rectangular, manufactured in 2 parts	1601–1800 x 55 mm	piece	224,75
	<b>LTUBE11712 TUB-UMR 1801–2000</b> , rectangular, manufactured in 2 parts	1801–2000 x 55 mm	piece	241,72
<b>Substrate elements for TUB-LINE (linear drainage) – made to measure</b>				
	<b>LTUBE94114 TUB-LINE UQ 800–900</b> , square	800–900 x 800–900 x 55 mm	piece	84,22
	<b>LTUBE94105 TUB-LINE UQ 900–1000</b> , square	900–1000 x 900–1000 x 55 mm	piece	105,88
	<b>LTUBE94112 TUB-LINE UQ 1000–1200</b> , square	1000–1200 x 1000–1200 x 55 mm	piece	126,24
	<b>LTUBE94115 TUB-LINE UR 900–1200/800–900</b> , rectangular	900–1200 x 800–900 x 55 mm	piece	119,36
	<b>LTUBE94106 TUB-LINE UR 1000–1200/900–1000</b> , rectangular	1000–1200 x 900–1000 x 55 mm	piece	126,24
	<b>LTUBE94113 TUB-LINE UR 1000–1200/1000–1100</b> , rectangular	1000–1200 x 1000–1100 x 55 mm	piece	126,24
	<b>LTUBE94107 TUB-LINE UR 1200–1400/900–1000</b> , rectangular	1200–1400 x 900–1000 x 55 mm	piece	217,05
	<b>LTUBE94108 TUB-LINE UR 1400–1600/900–1000</b> , rectangular	1400–1600 x 900–1000 x 55 mm	piece	219,30
	<b>LTUBE94116 TUB-LINE UR 1200–1400/1000–1100</b> , rectangular	1200–1400 x 1000–1100 x 55 mm	piece	203,24
	<b>LTUBE94117 TUB-LINE UR 1400–1600/1000–1100</b> , rectangular	1400–1600 x 1000–1100 x 55 mm	piece	206,42



Visit [www.luxelements.com](http://www.luxelements.com) for further information on TUB.

Data sheets, assembly instructions, test certificates and additional brochures under 'Downloads', videos under 'Practice' and on YouTube.

## ■ Systems in wooden sub-constructions

**LUX ELEMENTS® shower base elements**, flush with the floor, flat shower base height, with separate drainage technology (point or linear drainage) for installation in wooden sub-constructions – ready for tiling!

### ■ General properties

	TUB-H	TUB-LINE H
For barrier-free construction	■	■
Height-adjustable drain system	page 130	page 117
Factory sealing, compliant with DIN 18534	■	■
Grate fitting frame, factory sealed	■	—
Floor channel drain, factory sealed	—	■
Prefabricated gradient	■	■
Flat shower base height	■	■
Second drainage level	■	■
Click system for fastening the drain connection fitting	■	■
Separate floor drain support, horizontal	from page 130	from page 134
Extensive accessories	page 133	page 135
Matching mounting accessories	from page 136	from page 136
Made to measure possible	■	■

### ■ Installation principle, general

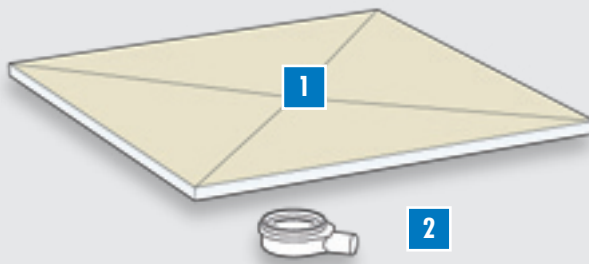

- 1 Shower base element** – with flat shower base height, factory sealed, square or rectangular, with four-sided gradient, integrated and sealed floor drain system
  - Details design variants: page 117
  - Details format variants: page 117

- 2 Drain support** – horizontal (DN 50), simple, fast and safe mounting by means of click system without gluing or screwing
  - Details: from page 130 (point drainage)
  - Details: page 134 (linear drainage)

### ■ Installation heights

Dimensions in mm. Measures without adhesive coating and tiles.

#### Point drainage

TUB-H

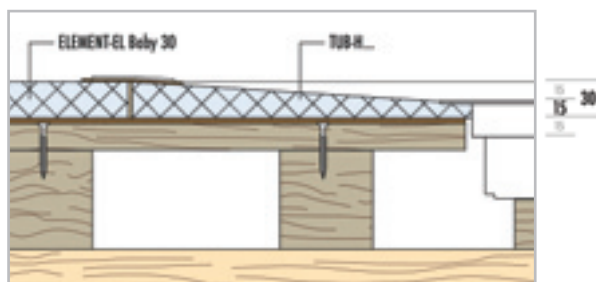

#### Linear drainage

TUB-LINE H

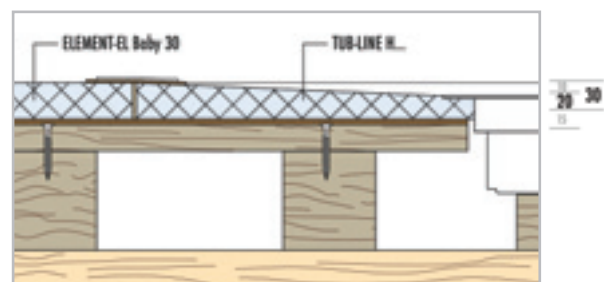

■ Properties, point drainage

**Grates/grate fitting frames** – compatible with all LUX ELEMENTS®-TUB-RA... variants, standard and design – see page 131

**Design variants** – basic shape: square or rectangular, **gradient**: four-sided, **drain position**: corner or centre

**Special features**: also as TUB-COMBI-S BOL with slope and shortening area, e.g. as bath tub replacement system (see page 124)

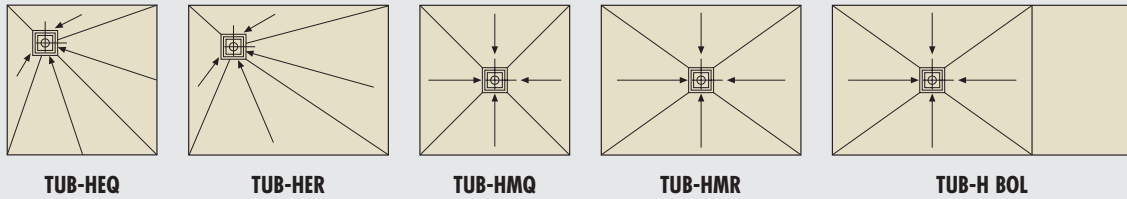

■ Properties, linear drainage

**Cover rail / Floor channel drain** – dimensions: 70 x 650 mm, 70 x 750 mm or 70 x 850 mm, depending on the size of the shower base

**Special features**: reversible cover rail for two design variants (brushed stainless steel and tileable rear side), tiling aid for clean tiling, height adjustable from 5 – 17 mm using height adapter, with odour trap



**Design variants** – basic shape: square or rectangular, **gradient**: four-sided, **drain position**: on shorter side

**Special features**: also as TUB-LINE H BOL with slope and shortening area, e.g. as bath tub replacement system (see page 128)

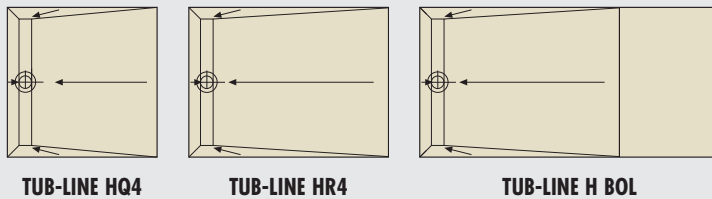

OVERVIEW STANDARD FORMATS SQUARE

		SIDE LENGTH LENGTH				
		800 mm	900 mm	1000 mm	1100 mm	1200 mm
SIDE LENGTH WIDTH	800 mm	TUB-HEQ (p. 121) TUB-HMQ (p. 121) TUB-LINE HQ4 (p. 127)				
	900 mm		TUB-HEQ (p. 121) TUB-HMQ (p. 121) TUB-LINE HQ4 (p. 127)			
	1000 mm			TUB-HEQ (p. 121) TUB-HMQ (p. 121) TUB-LINE HQ4 (p. 127)		
	1100 mm				TUB-HEQ (p. 121) TUB-HMQ (p. 121) TUB-LINE HQ4 (p. 127)	
	1200 mm					TUB-HEQ (p. 121) TUB-HMQ (p. 121) TUB-LINE HQ4 (p. 127)

OVERVIEW STANDARD FORMATS RECTANGULAR

		SIDE LENGTH – SHORT SIDE		
		800 mm	900 mm	1000 mm
SIDE LENGTH – LONG SIDE	900 mm	TUB-HER (p. 122) TUB-HMR (p. 123) TUB-LINE HR4 (p. 127)		
	1000 mm	TUB-HER (p. 122) TUB-HMR (p. 123) TUB-LINE HR4 (p. 127)	TUB-HER (p. 122) TUB-HMR (p. 123) TUB-LINE HR4 (p. 127)	
	1100 mm	TUB-HER (p. 122) TUB-HMR (p. 123) TUB-LINE HR4 (p. 127)	TUB-HER (p. 122) TUB-HMR (p. 123) TUB-LINE HR4 (p. 127)	TUB-HER (p. 122) TUB-HMR (p. 123) TUB-LINE HR4 (p. 127)
	1200 mm	TUB-HER (p. 122) TUB-HMR (p. 123) TUB-LINE HR4 (p. 127)	TUB-HER (p. 122) TUB-HMR (p. 123) TUB-LINE HR4 (p. 127)	TUB-HER (p. 122) TUB-HMR (p. 123) TUB-LINE HR4 (p. 127)
	1300 mm		TUB-HER (p. 122) TUB-HMR (p. 123) TUB-LINE HR4 (p. 127)	TUB-HER (p. 122) TUB-HMR (p. 123) TUB-LINE HR4 (p. 127)
	1400 mm		TUB-HER (p. 122) TUB-HMR (p. 123) TUB-LINE HR4 (p. 127)	TUB-HER (p. 122) TUB-HMR (p. 123) TUB-LINE HR4 (p. 127)
	1500 mm		TUB-HER (p. 122) TUB-HMR (p. 123) TUB-LINE HR4 (p. 127)	TUB-HER (p. 122) TUB-HMR (p. 123) TUB-LINE HR4 (p. 127)
	1600 mm		TUB-HER (p. 122) TUB-HMR (p. 123) TUB-LINE HR4 (p. 127)	TUB-HER (p. 122) TUB-HMR (p. 123) TUB-LINE HR4 (p. 127)
	1800 mm	TUB-H BOL (p. 125) TUB-LINE H BOL (p. 129)	TUB-H BOL (p. 125) TUB-LINE H BOL (p. 129)	TUB-H BOL (p. 125) TUB-LINE H BOL (p. 129)



Flush with the floor shower bases with separate drainage technology for installation in wooden sub-constructions

**TUB-H**

- Factory sealing
- Sealed floor drain fitting frame
- Prefabricated gradient (four-sided)
- Flat shower base height: 15/30 mm
- For barrier-free construction
- Second drainage level
- Secure click system for fastening the drain connection fitting
- Suitable drain systems, see page 130–133

Also available with floor channel drain, see TUB-LINE H, page 126

**Please note:** A planning expert is to be consulted when intervening in components with load-bearing function. Furthermore, national guidelines and generally recognised codes of practice must be observed.



Installation on wooden sub-constructions

- Installation height

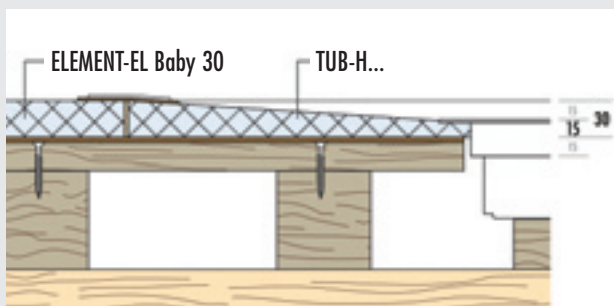

**Please note:** Dimensions in mm. Measures without adhesive coating and tiles.

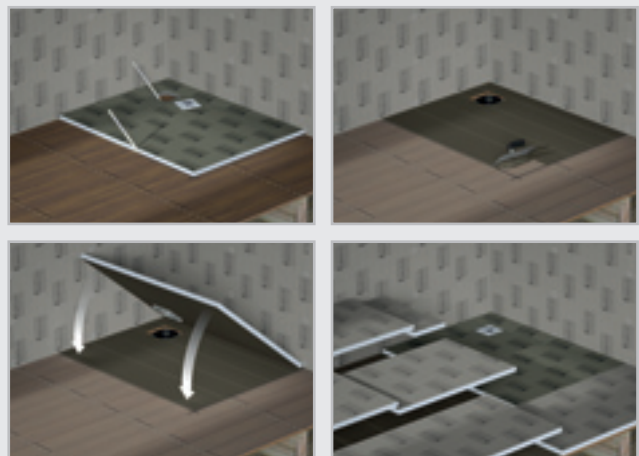

Installation in wooden sub-constructions

- Installation height

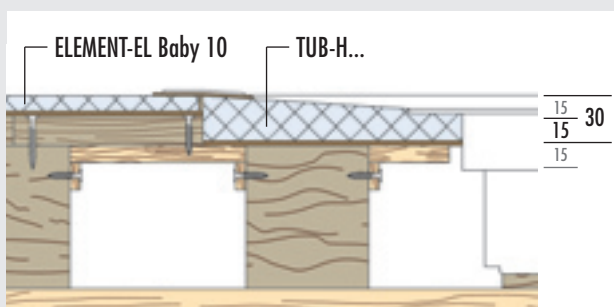

**Please note:** Dimensions in mm. Measures without adhesive coating and tiles.

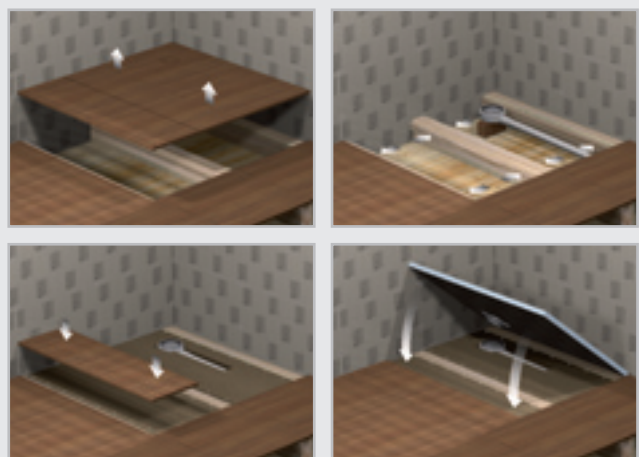



■ **PRODUCT SPECIFICATIONS – LUX ELEMENTS®-TUB-HEQ / -HMQ** Packaging specifications see p. 150 · Online calculator see p. 7 · \* standard-compliant according to DIN 18534

ARTICLE-NUMBER	ARTICLE-NAME / ARTICLE-DESCRIPTION	NOMINAL FORMATS/DIMENSIONS LENGTH x WIDTH x HEIGHT	UNIT	PRICE / UNIT €
----------------	------------------------------------	--	------	----------------

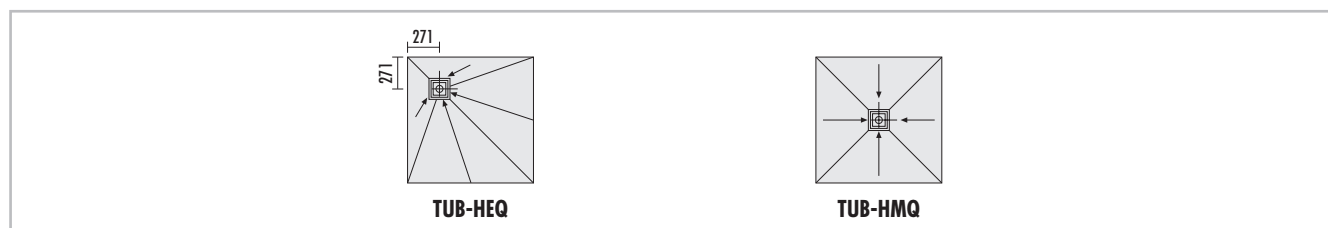

<b>TUB-H...Q</b> , hard foam shower base elements, square, with integrated and sealed floor drain support frame 135 x 135 mm, for installation in wooden sub-constructs. → <b>Drainage technology and accessories see page 130–133</b>				
	<b>LTUBE17004</b>	<b>TUB-HEQ 800*</b> , drain in the corner	800 x 800 x 15/30 mm	402,11
	<b>LTUBE17001</b>	<b>TUB-HEQ 900*</b> , drain in the corner	900 x 900 x 15/30 mm	417,73
	<b>LTUBE17003</b>	<b>TUB-HEQ 1000*</b> , drain in the corner	1000 x 1000 x 15/30 mm	436,56
	<b>LTUBE17005</b>	<b>TUB-HEQ 1100*</b> , drain in the corner	1100 x 1100 x 15/30 mm	456,98
	<b>LTUBE17002</b>	<b>TUB-HEQ 1200*</b> , drain in the corner	1200 x 1200 x 15/30 mm	477,40
	<b>LTUBE17104</b>	<b>TUB-HMQ 800*</b> , drain in the centre	800 x 800 x 15/30 mm	402,11
	<b>LTUBE17101</b>	<b>TUB-HMQ 900*</b> , drain in the centre	900 x 900 x 15/30 mm	417,74
	<b>LTUBE17103</b>	<b>TUB-HMQ 1000*</b> , drain in the centre	1000 x 1000 x 15/30 mm	436,55
	<b>LTUBE17105</b>	<b>TUB-HMQ 1100*</b> , drain in the centre	1100 x 1100 x 15/30 mm	456,98
	<b>LTUBE17102</b>	<b>TUB-HMQ 1200*</b> , drain in the centre	1200 x 1200 x 15/30 mm	477,41

LUX ELEMENTS manufactures individual customised and special products for TUB. These include dimensions, thicknesses, shapes etc. that deviate from the standard programme. For more information see page 5.

Visit [www.luxelements.com](http://www.luxelements.com) for further information on TUB. Data sheets, assembly instructions, test certificates and additional brochures under 'Downloads', videos under 'Practice' and on YouTube.

■ **PRODUCT SPECIFICATIONS – LUX ELEMENTS®-TUB-HER / -HMR** Packaging specifications see p. 150 · Online calculator see p. 7 · \* standard-compliant according to DIN 18534

ARTICLE-NUMBER	ARTICLE-NAME / ARTICLE-DESCRIPTION	NOMINAL FORMATS/DIMENSIONS LENGTH x WIDTH x HEIGHT	UNIT	PRICE / UNIT €
----------------	------------------------------------	--	------	----------------

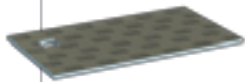
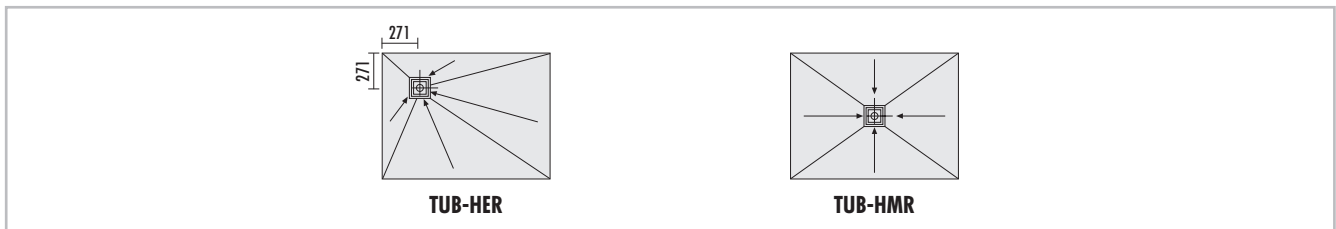

**TUB-H...R**, hard foam shower base elements, rectangular, with integrated and sealed floor drain support frame 135 x 135 mm, for installation in wooden sub-constructions. → **Drainage technology and accessories see page 130–133**

<b>LTUBE17014</b>	<b>TUB-HER 900/800*</b> , drain in the corner	900 x 800 x 15/30 mm	piece	409,92
<b>LTUBE17015</b>	<b>TUB-HER 1000/800*</b> , drain in the corner	1000 x 800 x 15/30 mm	piece	419,33
<b>LTUBE17016</b>	<b>TUB-HER 1100/800*</b> , drain in the corner	1100 x 800 x 15/30 mm	piece	439,11
<b>LTUBE17017</b>	<b>TUB-HER 1200/800*</b> , drain in the corner	1200 x 800 x 15/30 mm	piece	458,90
<b>LTUBE17019</b>	<b>TUB-HER 1000/900*</b> , drain in the corner	1000 x 900 x 15/30 mm	piece	427,14
<b>LTUBE17020</b>	<b>TUB-HER 1100/900*</b> , drain in the corner	1100 x 900 x 15/30 mm	piece	446,93
<b>LTUBE17011</b>	<b>TUB-HER 1200/900*</b> , drain in the corner	1200 x 900 x 15/30 mm	piece	466,70
<b>LTUBE17021</b>	<b>TUB-HER 1300/900*</b> , drain in the corner	1300 x 900 x 15/30 mm	piece	481,08
<b>LTUBE17013</b>	<b>TUB-HER 1400/900*</b> , drain in the corner	1400 x 900 x 15/30 mm	piece	495,46
<b>LTUBE17023</b>	<b>TUB-HER 1500/900*</b> , drain in the corner	1500 x 900 x 15/30 mm	piece	509,84
<b>LTUBE17012</b>	<b>TUB-HER 1600/900*</b> , drain in the corner	1600 x 900 x 15/30 mm	piece	531,06
<b>LTUBE17024</b>	<b>TUB-HER 1100/1000*</b> , drain in the corner	1100 x 1000 x 15/30 mm	piece	465,75
<b>LTUBE17025</b>	<b>TUB-HER 1200/1000*</b> , drain in the corner	1200 x 1000 x 15/30 mm	piece	485,52
<b>LTUBE17026</b>	<b>TUB-HER 1300/1000*</b> , drain in the corner	1300 x 1000 x 15/30 mm	piece	533,83
<b>LTUBE17027</b>	<b>TUB-HER 1400/1000*</b> , drain in the corner	1400 x 1000 x 15/30 mm	piece	567,77
<b>LTUBE17028</b>	<b>TUB-HER 1500/1000*</b> , drain in the corner	1500 x 1000 x 15/30 mm	piece	601,48
<b>LTUBE17029</b>	<b>TUB-HER 1600/1000*</b> , drain in the corner	1600 x 1000 x 15/30 mm	piece	636,08

contd. on page 123

■ **PRODUCT SPECIFICATIONS – LUX ELEMENTS®-TUB-HER / -HMR**

Packaging specifications see p. 150 · Online calculator see p. 7 · \* standard-compliant according to DIN 18534

ARTICLE-NUMBER	ARTICLE-NAME / ARTICLE-DESCRIPTION	NOMINAL FORMATS/DIMENSIONS LENGTH x WIDTH x HEIGHT	UNIT	PRICE / UNIT €
----------------	------------------------------------	--	------	----------------

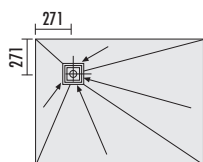

**TUB-HER**

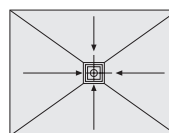

**TUB-HMR**

**TUB-H...R**, hard foam shower base elements, rectangular, with integrated and sealed floor drain support frame 135 x 135 mm, for installation in wooden sub-constructs. → **Drainage technology and accessories see page 130–133**

LTUBE17114	TUB-HMR 900/800*, drain in the centre	900 x 800 x 15/30 mm	piece	409,92
LTUBE17115	TUB-HMR 1000/800*, drain in the centre	1000 x 800 x 15/30 mm	piece	419,33
LTUBE17116	TUB-HMR 1100/800*, drain in the centre	1100 x 800 x 15/30 mm	piece	439,11
LTUBE17117	TUB-HMR 1200/800*, drain in the centre	1200 x 800 x 15/30 mm	piece	458,89
LTUBE17119	TUB-HMR 1000/900*, drain in the centre	1000 x 900 x 15/30 mm	piece	427,14
LTUBE17120	TUB-HMR 1100/900*, drain in the centre	1100 x 900 x 15/30 mm	piece	446,93
LTUBE17111	TUB-HMR 1200/900*, drain in the centre	1200 x 900 x 15/30 mm	piece	466,70
LTUBE17121	TUB-HMR 1300/900*, drain in the centre	1300 x 900 x 15/30 mm	piece	481,08
LTUBE17113	TUB-HMR 1400/900*, drain in the centre	1400 x 900 x 15/30 mm	piece	495,46
LTUBE17123	TUB-HMR 1500/900*, drain in the centre	1500 x 900 x 15/30 mm	piece	509,83
LTUBE17112	TUB-HMR 1600/900*, drain in the centre	1600 x 900 x 15/30 mm	piece	531,06
LTUBE17124	TUB-HMR 1100/1000*, drain in the centre	1100 x 1000 x 15/30 mm	piece	465,75
LTUBE17125	TUB-HMR 1200/1000*, drain in the centre	1200 x 1000 x 15/30 mm	piece	485,52
LTUBE17126	TUB-HMR 1300/1000*, drain in the centre	1300 x 1000 x 15/30 mm	piece	533,83
LTUBE17127	TUB-HMR 1400/1000*, drain in the centre	1400 x 1000 x 15/30 mm	piece	567,78
LTUBE17128	TUB-HMR 1500/1000*, drain in the centre	1500 x 1000 x 15/30 mm	piece	601,48
LTUBE17129	TUB-HMR 1600/1000*, drain in the centre	1600 x 1000 x 15/30 mm	piece	636,09

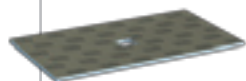

LUX ELEMENTS manufactures individual customised and special products for TUB.

These include dimensions, thicknesses, shapes etc. that deviate from the standard programme. For more information see page 5.



Visit [www.luxelements.com](http://www.luxelements.com) for further information on TUB.

Data sheets, assembly instructions, test certificates and additional brochures under 'Downloads', videos under 'Practice' and on YouTube.



Flush with the floor shower bases with separate drainage technology for installation in wooden sub-constructions for the substitution of bath tubs

## TUB-H BOL

- Factory sealing
- Sealed floor drain fitting frame
- Prefabricated gradient (four-sided)
- Can be shortened in length through area without gradient
- Flat shower base height: 15/30 mm
- For barrier-free construction
- Second drainage level
- Secure click system for fastening the drain connection fitting
- Suitable drain systems, see page 130–133

Also available with floor channel drain, see TUB-LINE H BOL, page 128

### Accessories (optional)

- Matching benches RELAX-BA from page 46

**Please note:** A planning expert is to be consulted when intervening in components with load-bearing function. Furthermore, national guidelines and generally recognised codes of practice must be observed.



- Shower base, can be cut to size

TUB-H BOL 1800/800 – can be cut to size to minimum 800 x 1200 mm

TUB-H BOL 1800/900 – can be cut to size to minimum 900 x 1200 mm

TUB-H BOL 1800/1000 – can be cut to size to minimum 1000 x 1200 mm

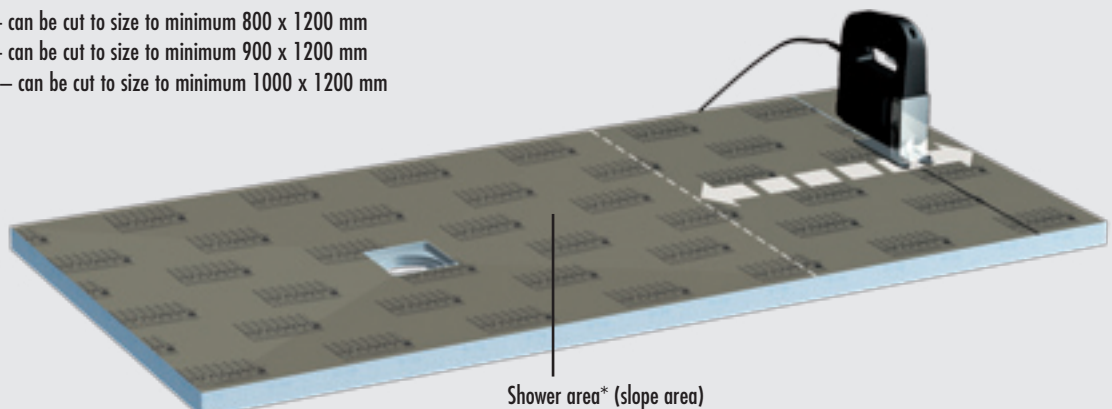

Shower area\* (slope area)

\*Please note: the fittings are to be located in the shower area

■ **PRODUCT SPECIFICATIONS – LUX ELEMENTS®-TUB-H BOL**

Packaging specifications see p. 151 · Online calculator see p. 7 · \* standard-compliant according to DIN 18534

ARTICLE-NUMBER	ARTICLE-NAME / ARTICLE-DESCRIPTION	NOMINAL FORMATS/DIMENSIONS LENGTH x WIDTH x HEIGHT	UNIT	PRICE / UNIT €
----------------	------------------------------------	--	------	----------------

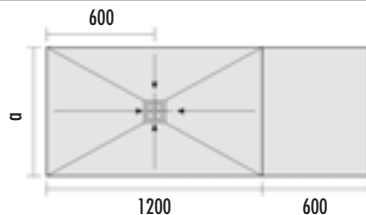

**TUB-LINE H BOL 1800/800: a = 800**  
**TUB-LINE H BOL 1800/900: a = 900**  
**TUB-LINE H BOL 1800/1000: a = 1000**

	<p><b>TUB-H BOL</b>, hard foam shower base elements for the substitution of bath tubs, with integrated and sealed floor drain support frame 135 x 135 mm, can be cut to length, drain in the slope area in the centre. → <b>Drainage technology and accessories see page 130–133</b></p>				
	<b>LTUBE17031</b>	<p><b>TUB-H BOL 1800/800*</b>,                      can be cut to length to minimum 800 x 1200 mm,                      slope area from 800 x 1200 mm</p>	1800 x 800 x 15/30 mm	piece	551,82
	<b>LTUBE17018</b>	<p><b>TUB-H BOL 1800/900*</b>,                      can be cut to length to minimum 900 x 1200 mm,                      slope area from 900 x 1200 mm</p>	1800 x 900 x 15/30 mm	piece	571,70
	<b>LTUBE17032</b>	<p><b>TUB-H BOL 1800/1000*</b>,                      can be cut to length to minimum 1000 x 1200 mm,                      slope area from 1000 x 1200 mm</p>	1800 x 1000 x 15/30 mm	piece	649,08



LUX ELEMENTS manufactures individual customised and special products for TUB. These include dimensions, thicknesses, shapes etc. that deviate from the standard programme. For more information see page 5.



Visit [www.luxelements.com](http://www.luxelements.com) for further information on TUB. Data sheets, assembly instructions, test certificates and additional brochures under 'Downloads', videos under 'Practice' and on YouTube.



Flush with the floor shower bases with separate drainage technology for installation in wooden sub-constructions

### TUB-LINE H

- Shower bases for the use in wooden sub-constructions with integrated and sealed floor channel drain (70 x 650 mm, 70 x 750 mm or 70 x 850 mm)
- Factory sealing
- Prefabricated gradient (four-sided)
- Flat shower base height: 20/30 mm
- Reversible channel cover rail offers two design options
- Clean tiling with tiling aid
- Height-adjustable for optimum adaptation to covering thickness
- For barrier-free construction
- Second drainage level
- Secure click system for fastening the drain connection fitting
- Suitable drain systems, see page 134

Also available with point drainage, see TUB-H, page 120

**Please note:** A planning expert is to be consulted when intervening in components with load-bearing function. Furthermore, national guidelines and generally recognised codes of practice must be observed.



#### ■ Installation height / on wooden sub-constructions

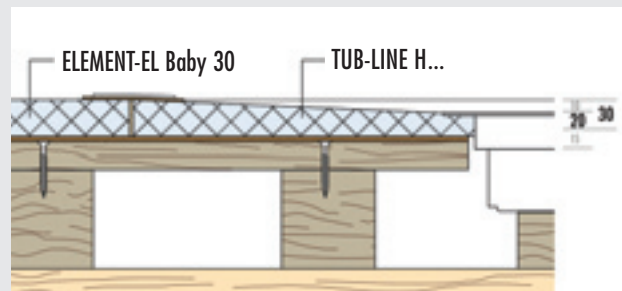

**Please note:** Dimensions in mm. Measures without adhesive coating and tiles.

#### ■ Installation height / in wooden sub-constructions

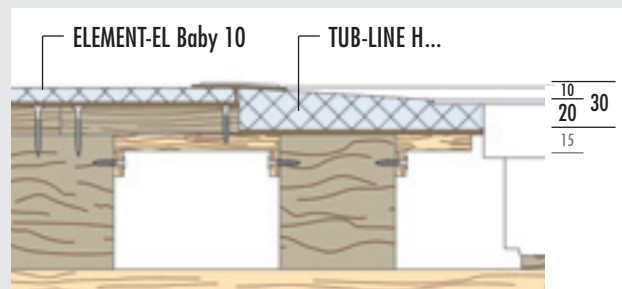

**Please note:** Dimensions in mm. Measures without adhesive coating and tiles.

■ **PRODUCT SPECIFICATIONS – LUX ELEMENTS®-TUB-LINE H**

Packaging specifications see p. 151 · Online calculator see p. 7 · \* standard-compliant according to DIN 18534

ARTICLE-NUMBER	ARTICLE-NAME / ARTICLE-DESCRIPTION	NOMINAL FORMATS/DIMENSIONS LENGTH x WIDTH x HEIGHT	UNIT	PRICE / UNIT €
----------------	------------------------------------	--	------	----------------

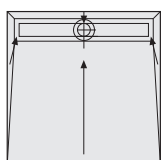

TUB-LINE HQ4

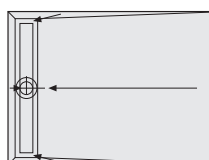

TUB-LINE HR4

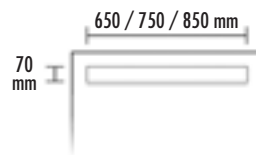

Floor channel drain

**TUB-LINE H**, hard foam shower base elements, with 4-sided gradient, with integrated and sealed floor channel drain 70 x 750 mm or 70 x 850 mm on shorter side, with cover rail and tiling aid made of brushed stainless steel, cover rail tileable on the rear side, with odour trap, height adjustable with height adapter from 5–17 mm, for installation in wooden sub-constructs. → **Drainage technology and accessories see page 134**

**with floor channel drain 70 x 650 mm**

LTUBE96006	TUB-LINE HQ4 800*, square	800 x 800 x 20/30 mm	piece	890,33
------------	---------------------------	----------------------	-------	--------

**with floor channel drain 70 x 750 mm**

LTUBE96001	TUB-LINE HQ4 900*, square	900 x 900 x 20/30 mm	piece	913,61
------------	---------------------------	----------------------	-------	--------

**with floor channel drain 70 x 850 mm**

LTUBE96003	TUB-LINE HQ4 1000*, square	1000 x 1000 x 20/30 mm	piece	936,89
------------	----------------------------	------------------------	-------	--------

LTUBE96007	TUB-LINE HQ4 1100*, square	1100 x 1100 x 20/30 mm	piece	979,63
------------	----------------------------	------------------------	-------	--------

LTUBE96004	TUB-LINE HQ4 1200*, square	1200 x 1200 x 20/30 mm	piece	1.022,36
------------	----------------------------	------------------------	-------	----------

**with floor channel drain 70 x 650 mm**

LTUBE96008	TUB-LINE HR4 900/800*, rectangular	900 x 800 x 20/30 mm	piece	877,24
------------	------------------------------------	----------------------	-------	--------

LTUBE96009	TUB-LINE HR4 1000/800*, rectangular	1000 x 800 x 20/30 mm	piece	892,64
------------	-------------------------------------	-----------------------	-------	--------

LTUBE96010	TUB-LINE HR4 1100/800*, rectangular	1100 x 800 x 20/30 mm	piece	908,05
------------	-------------------------------------	-----------------------	-------	--------

LTUBE96011	TUB-LINE HR4 1200/800*, rectangular	1200 x 800 x 20/30 mm	piece	923,45
------------	-------------------------------------	-----------------------	-------	--------

**with floor channel drain 70 x 750 mm**

LTUBE96012	TUB-LINE HR4 1000/900*, rectangular	1000 x 900 x 20/30 mm	piece	920,41
------------	-------------------------------------	-----------------------	-------	--------

LTUBE96013	TUB-LINE HR4 1100/900*, rectangular	1100 x 900 x 20/30 mm	piece	937,42
------------	-------------------------------------	-----------------------	-------	--------

LTUBE96002	TUB-LINE HR4 1200/900*, rectangular	1200 x 900 x 20/30 mm	piece	963,45
------------	-------------------------------------	-----------------------	-------	--------

LTUBE96014	TUB-LINE HR4 1300/900*, rectangular	1300 x 900 x 20/30 mm	piece	989,48
------------	-------------------------------------	-----------------------	-------	--------

LTUBE96005	TUB-LINE HR4 1400/900*, rectangular	1400 x 900 x 20/30 mm	piece	1.016,44
------------	-------------------------------------	-----------------------	-------	----------

LTUBE96015	TUB-LINE HR4 1500/900*, rectangular	1500 x 900 x 20/30 mm	piece	1.043,39
------------	-------------------------------------	-----------------------	-------	----------

LTUBE96016	TUB-LINE HR4 1600/900*, rectangular	1600 x 900 x 20/30 mm	piece	1.056,63
------------	-------------------------------------	-----------------------	-------	----------

**with floor channel drain 70 x 850 mm**

LTUBE96017	TUB-LINE HR4 1100/1000*, rectangular	1100 x 1000 x 20/30 mm	piece	996,66
------------	--------------------------------------	------------------------	-------	--------

LTUBE96018	TUB-LINE HR4 1200/1000*, rectangular	1200 x 1000 x 20/30 mm	piece	1.022,69
------------	--------------------------------------	------------------------	-------	----------

LTUBE96019	TUB-LINE HR4 1300/1000*, rectangular	1300 x 1000 x 20/30 mm	piece	1.048,72
------------	--------------------------------------	------------------------	-------	----------

LTUBE96020	TUB-LINE HR4 1400/1000*, rectangular	1400 x 1000 x 20/30 mm	piece	1.075,68
------------	--------------------------------------	------------------------	-------	----------

LTUBE96021	TUB-LINE HR4 1500/1000*, rectangular	1500 x 1000 x 20/30 mm	piece	1.102,64
------------	--------------------------------------	------------------------	-------	----------

LTUBE96022	TUB-LINE HR4 1600/1000*, rectangular	1600 x 1000 x 20/30 mm	piece	1.119,07
------------	--------------------------------------	------------------------	-------	----------



LUX ELEMENTS manufactures individual customised and special products for TUB.

These include dimensions, thicknesses, shapes etc. that deviate from the standard programme. For more information see page 5.



Visit [www.luxelements.com](http://www.luxelements.com) for further information on TUB.

Data sheets, assembly instructions, test certificates and additional brochures under 'Downloads', videos under 'Practice' and on YouTube.



Flush with the floor shower bases with separate drainage technology for installation in wooden sub-constructions for the substitution of bath tubs

### TUB-LINE H BOL

- Shower base element with integrated and sealed floor channel drain (70 x 650 mm, 70 x 750 mm or 70 x 850 mm)
- Factory sealing
- Prefabricated gradient (four-sided)
- Flat shower base height: 20/30 mm
- Reversible channel cover rail offers two design options
- Clean tiling with tiling aid
- Height-adjustable for optimum adaptation to covering thickness
- Can be shortened in length through area without gradient
- For barrier-free construction
- Second drainage level
- Secure click system for fastening the drain connection fitting
- Suitable drain systems, see page 134

Also available with point drainage, see TUB-H BOL, page 124

#### Accessories (optional)

- Matching benches RELAX-BA from page 46

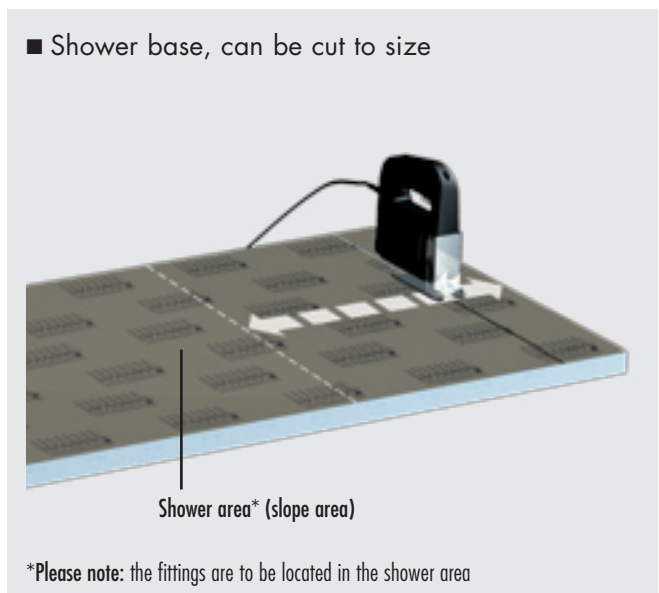



■ **PRODUCT SPECIFICATIONS – LUX ELEMENTS®-TUB-LINE H BOL**

Packaging specifications see p. 151 · Online calculator see p. 7 · \* standard-compliant according to DIN 18534

ARTICLE-NUMBER	ARTICLE-NAME / ARTICLE-DESCRIPTION	NOMINAL FORMATS/DIMENSIONS LENGTH x WIDTH x HEIGHT	UNIT	PRICE / UNIT €
----------------	------------------------------------	--	------	----------------

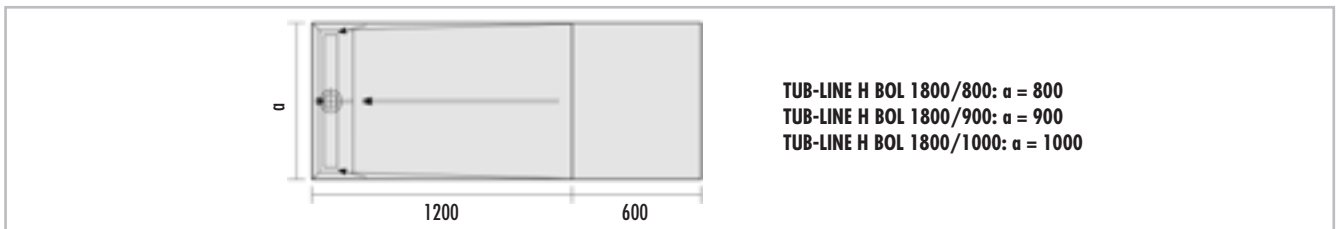

	<b>TUB-LINE H BOL</b> , hard foam shower base elements for the substitution of bath tubs, with 4-sided gradient, with integrated and sealed floor channel drain on shorter side, with cover rail and tiling aid made of brushed stainless steel, cover rail tileable on the rear side, with odour trap, height adjustable with height adapter from 5–17 mm. → <b>Drainage technology and accessories see page 134</b>				
	<b>with floor channel drain 70 x 650 mm</b>				
	<b>LTUBE97102</b>	<b>TUB-LINE H BOL 1800/800*</b> , can be cut to length to minimum 800 x 1200 mm, slope area from 800 x 1200 mm	1800 x 800 x 20/30 mm	piece	1.019,80
	<b>with floor channel drain 70 x 750 mm</b>				
<b>LTUBE97101</b>	<b>TUB-LINE H BOL 1800/900*</b> , can be cut to length to minimum 900 x 1200 mm, slope area from 900 x 1200 mm	1800 x 900 x 20/30 mm	piece	1.063,78	
<b>with floor channel drain 70 x 850 mm</b>					
<b>LTUBE97103</b>	<b>TUB-LINE H BOL 1800/1000*</b> , can be cut to length to minimum 1000 x 1200 mm, slope area from 1000 x 1200 mm	1800 x 1000 x 20/30 mm	piece	1.157,68	



LUX ELEMENTS manufactures individual customised and special products for TUB.

These include dimensions, thicknesses, shapes etc. that deviate from the standard programme. For more information see page 5.



Visit [www.luxelements.com](http://www.luxelements.com) for further information on TUB.

Data sheets, assembly instructions, test certificates and additional brochures under 'Downloads', videos under 'Practice' and on YouTube.

## ■ Drain technology and accessories

**TUB floor drain systems** – a general differentiation is made in the drain systems for the TUB shower bases between **free combinable systems** and **completely assembled systems** (from page 132).



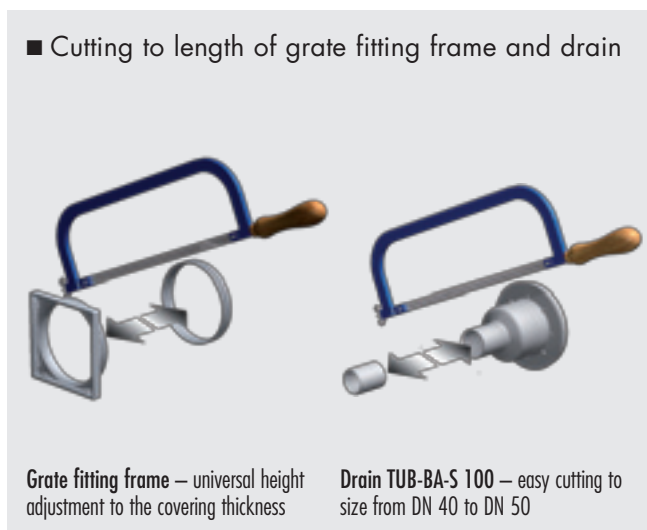

### TUB combinable floor drain systems

- Floor drain supports – TUB-BA-...  
vertical or horizontal
- Grate fitting frame with standard grate – TUB-RA-S
- Grate fitting frame with design grate – TUB-RA-D...  
Design variants see page 67
- Drainage capacity in accordance with DIN EN 1253 [l/s]:  
Standard odour trap DN 50 vertical  
– TUB-BA-S with standard grate: 1,7 l/s  
– TUB-BA-S 100 with standard grate: 1,2 l/s  
Standard odour trap DN 50 horizontal  
– TUB-BA-W with standard grate: 1,0 l/s



### ■ PRODUCT SPECIFICATIONS – TUB COMBINABLE FLOOR DRAIN SYSTEMS

Packaging specifications see p. 152 · Online calculator see p. 7

	ARTICLE-NUMBER	ARTICLE-NAME / ARTICLE-DESCRIPTION	NOMINAL FORMATS/DIMENSIONS LENGTH x WIDTH	UNIT	PRICE / UNIT €
	LTUBE1102	TUB-BA-S, floor drain support DN 50 vertical, for 160 mm core drill hole, with odour trap		set	49,45
	LTUBE1103	TUB-BA-S 100, floor drain support DN 40/DN 50 vertical, for 100 mm core drill hole, with odour trap		set	49,45
	LTUBE1101	TUB-BA-W, floor drain support DN 50 horizontal, with odour trap		set	41,70
	LTUBE1100	TUB-RA-S, grate fitting frame made of ABS and standard stainless steel grate, universal height adjustment to suit tile thickness	external frame dimensions: 130 x 130 mm, grate: 120 x 120 mm	set	32,84







contd. on page 131

## DRAIN TECHNOLOGY AND ACCESSORIES – SHOWERS

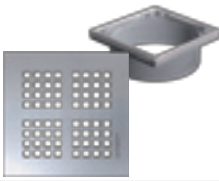
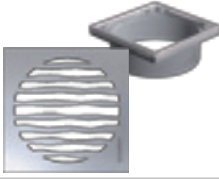
### POINT DRAINAGE / FLOOR DRAIN SYSTEMS AND ACCESSORIES

#### ■ PRODUCT SPECIFICATIONS – TUB COMBINABLE FLOOR DRAIN SYSTEMS

Packaging specifications see p. 152 · Online calculator see p. 7

	ARTICLE-NUMBER	ARTICLE-NAME / ARTICLE-DESCRIPTION	NOMINAL FORMATS/DIMENSIONS LENGTH x WIDTH	UNIT	PRICE / UNIT €
	<b>LTUBE1104</b>	<b>TUB-RA-DA</b> , grate fitting frame made from ABS, with frame and design grate 'ANGOLO' made of stainless steel, universal height adjustment to suit tile thickness is possible	external frame dimensions: 132 x 132 mm, grate: 120 x 120 mm	set	103,61
	<b>LTUBE1105</b>	<b>TUB-RA-DC</b> , grate fitting frame made from ABS, with frame and design grate 'CUBE' made of stainless steel, universal height adjustment to suit tile thickness is possible	external frame dimensions: 132 x 132 mm, grate: 120 x 120 mm	set	114,20
	<b>LTUBE1106</b>	<b>TUB-RA-DM</b> , grate fitting frame made from ABS, with frame and design grate 'MARE' made of stainless steel, universal height adjustment to suit tile thickness is possible	external frame dimensions: 132 x 132 mm, grate: 120 x 120 mm	set	103,36
	<b>LTUBE1107</b>	<b>TUB-RA-DL</b> , grate fitting frame made from ABS, with frame and design grate 'LUMEN' made of stainless steel, universal height adjustment to suit tile thickness is possible	external frame dimensions: 132 x 132 mm, grate: 120 x 120 mm	set	103,41
	<b>LTUBE1108</b>	<b>TUB-RA-DV</b> , grate fitting frame made from ABS, with frame made of stainless steel and tileable cover 'VARI' made of stainless steel, universal height adjustment to suit tile thickness is possible, thickness of surface covering (tile and adhesive) for the shower tray minimum 5 mm, for the tileable covering 8 mm	external frame dimensions: 132 x 132 mm, cover: 110 x 110 mm	set	103,29
	<b>LTUBE1110</b>	<b>TUB-RA-DS</b> , grate fitting frame made from ABS, with frame and design grate 'Slot' made of stainless steel, universal height adjustment to suit tile thickness is possible, with locking system	external frame dimensions: 132 x 132 mm, grate: 120 x 120 mm	set	132,04
	<b>LTUBE1109</b>	<b>TUB-RA-DF</b> , grate fitting frame made from ABS, with frame made of stainless steel and tileable plastic cover, universal height adjustment to suit tile thickness is possible, with locking system, thickness of surface covering (tile and adhesive) for the shower tray minimum 14 mm, for the tileable covering 11 mm	external frame dimensions: 132 x 132 mm, cover: 110 x 110 mm	set	155,40
	<b>LTUBE1001</b>	<b>TUB-RA-A</b> , grate fitting frame made of ABS plastic, including standard stainless steel grate 120 x 120 mm, overall height 85 mm, universal height adjustment to suit tile thickness is possible	external frame dimensions: 130 x 130 mm; frame height: 9 mm	set	44,68

To fit all LUX ELEMENTS®-TUB-shower base elements and shower drain element TUB-MQ-SET 300 · Thickness of surface covering (tile and adhesive): TUB-RA-S/DA/DC/DM/DL/DS: for the shower tray: minimum 5 mm / TUB-RA-DV: for the shower tray: minimum 5 mm / for the tileable covering: 8 mm / TUB-RA-DF: for the shower tray: minimum 14 mm / for the tileable covering: 11 mm · **Please note:** Flow capacity when using design grates and/or accessories, see data sheet TUB.

## TUB complete floor drain systems

- Set consisting of standard grate with grate fitting frame and vertical or horizontal floor drain support
- Simple to mount
- Drainage capacity in accordance with DIN EN 1253 [l/s]:
  - Standard odour trap DN 50 vertical
    - TUB-BAS-S with standard grate: 1,7 l /s
    - TUB-BAS-S 100 with standard grate: 1,2 l /s
  - Standard odour trap DN 50 horizontal
    - TUB-BAW-S with standard grate: 1,0 l /s

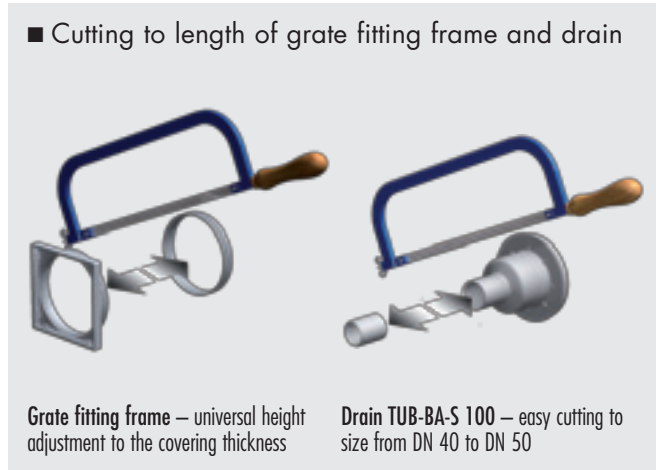

### ■ PRODUCT SPECIFICATIONS – TUB COMPLETE FLOOR DRAIN SYSTEMS

Packaging specifications see p. 152 · Online calculator see p. 7

	ARTICLE-NUMBER	ARTICLE-NAME / ARTICLE-DESCRIPTION	NOMINAL FORMATS/DIMENSIONS LENGTH x WIDTH	UNIT	PRICE / UNIT €
	<b>LTUBE1180</b>	<b>TUB-BAS-S</b> , floor drain support DN 50 vertical, for 160 mm core drill hole, with odour trap, incl. grate fitting frame made of ABS and standard stainless steel grate, universal height adjustment to suit tile thickness	external frame dimensions: 130 x 130 mm, grate: 120 x 120 mm	set	75,91
	<b>LTUBE1193</b>	<b>TUB-BAS-S 100</b> , floor drain support DN 40/DN 50 vertical, for 100 mm core drill hole, with odour trap, incl. grate fitting frame made of ABS and standard stainless steel grate, universal height adjustment to suit tile thickness	external frame dimensions: 130 x 130 mm, grate: 120 x 120 mm	set	75,91
	<b>LTUBE1184</b>	<b>TUB-BAW-S</b> , floor drain support DN 50 horizontal, with odour trap, incl. grate fitting frame made of ABS and standard stainless steel grate, universal height adjustment to suit tile thickness	external frame dimensions: 130 x 130 mm, grate: 120 x 120 mm	set	68,24

To fit all LUX ELEMENTS®-TUB-shower base elements and shower drain element TUB-MQ-SET 300

Please note: Flow capacity when using design grates and/or accessories, see data sheet TUB.



Visit [www.luxelements.com](http://www.luxelements.com) for further information on TUB.

Data sheets, assembly instructions, test certificates and additional brochures under 'Downloads', videos under 'Practice' and on YouTube.





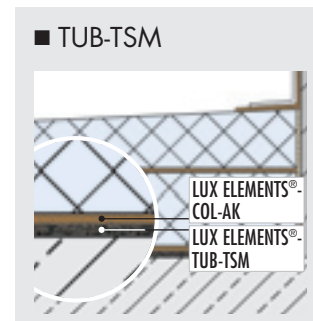
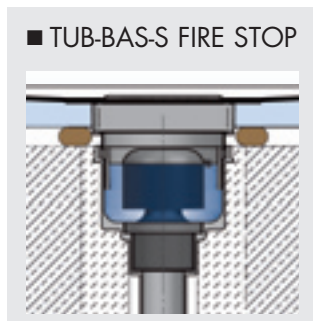



## TUB floor drain systems accessories

- To fit all LUX ELEMENTS®-TUB-floor drain systems (TUB-BAZ HS does not fit TUB-COMBI MQ SET 300)
- Impact sound insulating mat for the reduction of noise nuisance caused by running water, e.g. in bathrooms of apartment blocks, nursing homes and hotels: TUB-TSM
- Fire protection set for more safety: TUB-BAS-S FIRE STOP



### ■ PRODUCT SPECIFICATIONS – TUB FLOOR DRAIN SYSTEMS ACCESSORIES

Packaging specifications see p. 152 · Online calculator see p. 7

	ARTICLE-NUMBER	ARTICLE-NAME / ARTICLE-DESCRIPTION	NOMINAL FORMATS/DIMENSIONS LENGTH x WIDTH x HEIGHT	UNIT	PRICE / UNIT €
	<b>LTUBE1 188</b>	<b>TUB-BAZ STOP</b> , odour, foam and vermin barrier; can also be retrofitted to existing installed drains		piece	64,23
	<b>LTUBE1 189</b>	<b>TUB-BAZ HS</b> , removable hair trap		piece	21,90
	<b>LTUBE1 200</b>	<b>TUB-BAZ DN 50/40</b> , reducer, DN 50 to DN 40, with lip seal		piece	11,85
	<b>LTUBE1 190</b>	<b>TUB-BAZ BST</b> , adapter, DN 50 to British Standard		piece	11,72
	<b>LTUBE1 192</b>	<b>TUB-BAZ HTK</b> , elbow, DN 50, swivel joint 0–87° (infinitely variable)		piece	9,08
	<b>LTUBE1 197</b>	<b>TUB-BAS-S FIRE STOP</b> , floor drain support DN 50 for 160 mm core drill hole, vertical, with odour trap, incl. grate fitting frame made of ABS and standard stainless steel grate, incl. adapter part TUB-BAZ VER and fire-protection component	external frame dimensions: 130 x 130 mm, grate: 120 x 120 mm	set	239,15
	<b>LTUBE1 198</b>	<b>TUB-BAZ DGD</b> , conduit seal for core drill hole in diameter 160 mm, with fire protection in conjunction with TUB-BAS-S FIRE STOP		piece	156,87
	<b>LTUBE1 191.6</b>	<b>TUB-TSM 6</b> , impact sound insulating mat 6 mm for LUX ELEMENTS flush with the floor shower base elements	1250 x 1250 x 6 mm	piece	59,10
	<b>LTUBE1 191.12</b>	<b>TUB-TSM 12</b> , impact sound insulating mat 12 mm for LUX ELEMENTS flush with the floor shower base elements, for elevated requirements	1250 x 1250 x 12 mm	piece	85,48

To fit all LUX ELEMENTS®-TUB-floor drain systems (TUB-BAZ HS does not fit TUB-COMBI MQ SET 300)

Visit [www.luxelements.com](http://www.luxelements.com) for further information on TUB.  
Data sheets, assembly instructions, test certificates and additional brochures under 'Downloads', videos under 'Practice' and on YouTube.

## Floor drain supports and accessories TUB-LINE

- To fit all LUX ELEMENTS®-TUB-LINE shower bases and floor channel drains
- Drainage capacity in accordance with DIN EN 1253 [l/s]:
  - vertical (TUB-LINE BA-S): 0,8 l/s
  - horizontal (TUB-LINE BA-W 22): 0,8 l/s
- Impact sound insulating mat for the reduction of noise nuisance caused by running water, e.g. in apartment blocks, nursing homes and hotels: TUB-TSM
- Fire protection set for more safety:  
TUB-LINE BA-S FIRE STOP

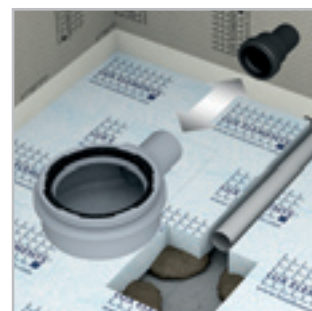

■ TUB-LINE BA-S FIRE STOP

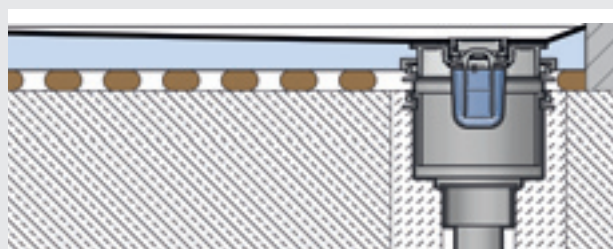

■ TUB-TSM

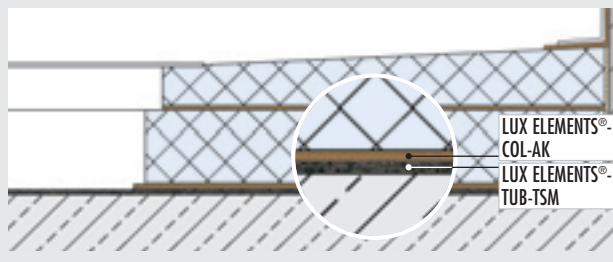

## DRAIN TECHNOLOGY AND ACCESSORIES – SHOWERS

### LINEAR DRAINAGE / FLOOR DRAIN SYSTEMS AND ACCESSORIES

#### ■ PRODUCT SPECIFICATIONS – TUB-LINE FLOOR DRAIN SUPPORTS AND ACCESSORIES

Packaging specifications see p. 153 · Online calculator see p. 7

	ARTICLE-NUMBER	ARTICLE-NAME / ARTICLE-DESCRIPTION	NOMINAL FORMATS/DIMENSIONS LENGTH x WIDTH x HEIGHT	UNIT	PRICE / UNIT €
	LTUBE1113	<b>TUB-LINE BA-S</b> , floor drain support DN 50 vertical, for 160 mm core drill hole, without odour trap		piece	48,15
	LTUBE1112.22	<b>TUB-LINE BA-W 22</b> , floor drain support DN 50 horizontal, without odour trap		piece	40,79
	LTUBE1112.50	<b>TUB-LINE BA-W 50</b> , floor drain support DN 50 horizontal, without odour trap, to fit TUB-LINE BA-GV 50		piece	47,84
	LTUBE1115.50	<b>TUB-LINE BA-GV 50</b> , odour trap, sealing water height 50 mm, to fit TUB-LINE BA-W 50		piece	23,43
	LTUBE1288	<b>TUB-LINE BAZ STOP</b> , odour, foam and vermin barrier, can also be retrofitted to existing installed channel drains for the design variants TUB-LINE		piece	62,87
	LTUBE1114	<b>TUB-LINE BAZ HS</b> , removable hair trap for TUB-LINE		piece	21,88
	LTUBE1200	<b>TUB-BAZ DN 50/40</b> , reducer, DN 50 to DN 40, with lip seal		piece	11,85
	LTUBE1190	<b>TUB-BAZ BST</b> , adapter, DN 50 to British Standard,		piece	11,72
	LTUBE1192	<b>TUB-BAZ HTK</b> , elbow, DN 50, swivel joint 0–87° (infinitely variable)		piece	9,08
	LTUBE1289	<b>TUB-LINE BA-S FIRE STOP</b> , floor drain support DN 50 vertical for 160 mm core drill hole, with odour trap, incl. adapter part TUB-BAZ VER and fire-protection component		set	239,15
	LTUBE1198	<b>TUB-BAZ DGD</b> , conduit seal for core drill hole in diameter 160 mm, with fire protection in conjunction with TUB-LINE BA-S FIRE STOP		piece	156,87
	LTUBE1191.6	<b>TUB-TSM 6</b> , impact sound insulating mat 6 mm for LUX ELEMENTS flush with the floor shower base elements	1250 x 1250 x 6 mm	piece	59,10
	LTUBE1191.12	<b>TUB-TSM 12</b> , impact sound insulating mat 12 mm for LUX ELEMENTS flush with the floor shower base elements, for elevated requirements	1250 x 1250 x 12 mm	piece	85,48



Visit [www.luxelements.com](http://www.luxelements.com) for further information on TUB.

Data sheets, assembly instructions, test certificates and additional brochures under 'Downloads', videos under 'Practice' and on YouTube.



## Mounting accessories for TUB and TUB-LINE **TUB-KIT**

- Necessary mounting material for installation in one kit
- Three variants, tailored to the shower base size
- Cut protection tape DRY-SB see page 24, further mounting material from page 20

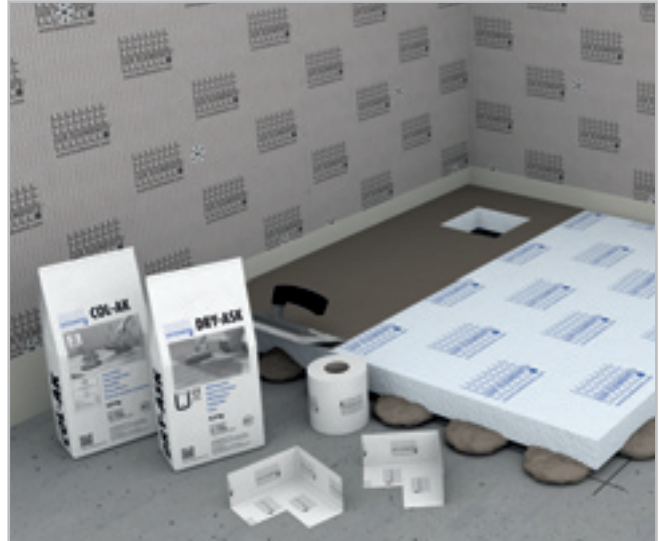

### Fixing adhesive – COL-AK

- Ready-mixed dry mortar
- For the attachment, levelling and adhesion of LUX ELEMENTS® hard foam support elements
- Stable, fast bonding, waterproof
- Low on chromate in accordance with EC directive 2003/53/EC

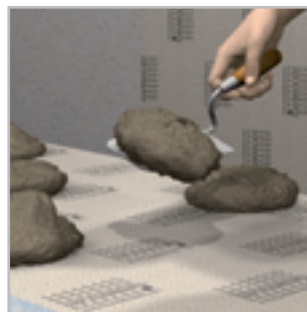

### Sealing filler – DRY-ASK

- Single-component, water-impermeable, crack-bridging and flexible sealing compound
- For large seals on LUX ELEMENTS® hard foam support elements

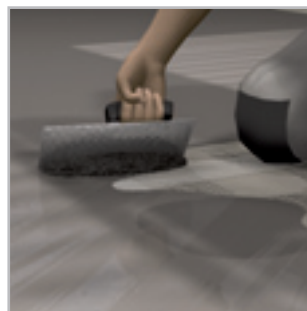

### Sealing tape – DRY-DB

- Extremely thin, tear-resistant, elastic and vapour-permeable special tissue
- For connection sealing in conjunction with DRY-ASK sealing filler or shower bases
- For wall/floor connections, inner corners, outer corners







■ PRODUCT SPECIFICATIONS – LUX ELEMENTS®-TUB-KIT

Packaging specifications see p. 153 · Online calculator see p. 7

ARTICLE-NUMBER	ARTICLE-NAME / ARTICLE-DESCRIPTION	UNIT	PRICE / UNIT €
----------------	------------------------------------	------	----------------

■ Range of application

Length TUB a in mm	Length TUB b in mm	without substrate element, full coverage	without substrate element, on 15 mm dots	with substrate element, full coverage	with substrate element, on 15 mm dots
900	900	TUB-KIT UNI	TUB-KIT UNI GK	TUB-KIT UNI	TUB-KIT UNI GK
1000	800	TUB-KIT UNI	TUB-KIT UNI GK	TUB-KIT UNI	TUB-KIT UNI GK
1000	1000	TUB-KIT UNI	TUB-KIT UNI GK	TUB-KIT UNI	TUB-KIT UNI GK
1200	1200	TUB-KIT UNI	TUB-KIT UNI GK	TUB-KIT UNI GK	TUB-KIT UNI GG
1400	1400	TUB-KIT UNI GK	TUB-KIT UNI GG	TUB-KIT UNI GK	TUB-KIT UNI GG
1500	1500	TUB-KIT UNI GK	TUB-KIT UNI GG	TUB-KIT UNI GK	TUB-KIT UNI GG
2000	1000	TUB-KIT UNI GK	TUB-KIT UNI GG	TUB-KIT UNI GK	TUB-KIT UNI GG

	<b>LTUBE1090</b>	<b>TUB-KIT UNI</b> , mounting kit for shower bases: 5 kg COL-AK, 3,5 kg DRY-ASK, 10 m DRY-DB, 2 pieces DRY-DBIE (inner corners)	Kit	130,32
	<b>LTUBE1098</b>	<b>TUB-KIT UNI GK</b> , mounting kit for shower bases: 3 x 5 kg COL-AK, 3,5 kg DRY-ASK, 10 m DRY-DB, 2 pieces DRY-DBIE (inner corners)	Kit	171,17
	<b>LTUBE1099</b>	<b>TUB-KIT UNI GG</b> , mounting kit for shower bases: 5 x 5 kg COL-AK, 3,5 kg DRY-ASK, 10 m DRY-DB, 2 pieces DRY-DBIE (inner corners)	Kit	195,50



Visit [www.luxelements.com](http://www.luxelements.com) for further information on TUB.

Data sheets, assembly instructions, test certificates and additional brochures under 'Downloads', videos under 'Practice' and on YouTube.

## Packaging specifications

### LUX ELEMENTS®-ELEMENT

see page 13/15/17

INDIVIDUAL PACKAGING							
ARTICLE-NUMBER	ARTICLE-NAME	CONTAINER	DIMENSIONS – LENGTH x WIDTH x HEIGHT		UNIT	WEIGHT/UNIT	WEIGHT/PALLET
LELEEMIX2000	ELEMENT-EL MIX 1	pallet	2500 x 1200 x 710 mm		set	267,90 kg	287,90 kg
LELEEMIX2001	ELEMENT-EL MIX 2		2500 x 1200 x 800 mm			271,50 kg	291,50 kg
LELEEMIX2002	ELEMENT-EL MIX 3		2500 x 1200 x 600 mm			258,00 kg	278,00 kg
LELEEMIX2003	ELEMENT-EL MIX 4		2500 x 1200 x 820 mm			275,10 kg	295,10 kg
LELEEMIX1000	ELEMENT-EL BABY MIX 1		1250 x 1200 x 750 mm			228,00 kg	238,00 kg
LELEEMIX3000	ELEMENT-EL MAXI MIX 1		2500 x 900 x 760 mm			306,00 kg	320,00 kg
COLLECTIVE PACKAGING – PALLET PER PRODUCT							
ARTICLE-NUMBER	ARTICLE-NAME	PIECE/PALLET	m <sup>2</sup> /PALLET	PALLET DIMENSIONS LENGTH x WIDTH x HEIGHT	UNIT	WEIGHT/ UNIT	WEIGHT/ PALLET
LELEE1119	ELEMENT-EL 10	80	120	2500 x 1200 x 540 mm	m <sup>2</sup>	~ 3,20 kg	400 kg
LELEE1131	ELEMENT-EL 12	80	120	2500 x 1200 x 620 mm		~ 3,30 kg	400 kg
LELEE1120	ELEMENT-EL 20	80	120	2500 x 1200 x 920 mm		~ 3,50 kg	435 kg
LELEE1121	ELEMENT-EL 30	52	78	2500 x 1200 x 900 mm		~ 3,80 kg	310 kg
LELEE1123	ELEMENT-EL 40	40	60	2500 x 1200 x 920 mm		~ 4,10 kg	260 kg
LELEE1122	ELEMENT-EL 50	32	48	2500 x 1200 x 920 mm		~ 4,40 kg	225 kg
LELEE1133	ELEMENT-EL 80	24	36	2500 x 1200 x 1080 mm		~ 5,30 kg	205 kg
LELEE1137	ELEMENT-EL 100	20	30	2500 x 1200 x 1150 mm		~ 6,00 kg	190 kg
LELEE1116	ELEMENT-EL Baby 4	160	120	1250 x 1200 x 440 mm		~ 3,00 kg	370 kg
LELEE1117	ELEMENT-EL Baby 6	160	120	1250 x 1200 x 600 mm		~ 3,00 kg	370 kg
LELEE1118	ELEMENT-EL Baby 10	100	75	1250 x 1200 x 630 mm		~ 3,20 kg	250 kg
LELEE1135	ELEMENT-EL Baby 12	80	60	1250 x 1200 x 620 mm		~ 3,30 kg	200 kg
LELEE1141	ELEMENT-EL Baby 20	80	60	1250 x 1200 x 920 mm		~ 3,50 kg	200 kg
LELEE1142	ELEMENT-EL Baby 30	52	39	1250 x 1200 x 900 mm		~ 3,80 kg	160 kg
LELEE1143	ELEMENT-EL Baby 40	40	30	1250 x 1200 x 920 mm		~ 4,10 kg	130 kg
LELEE1144	ELEMENT-EL Baby 50	32	24	1250 x 1200 x 920 mm		~ 4,40 kg	115 kg
LELEE1145	ELEMENT-EL Baby 80	24	18	1250 x 1200 x 1080 mm		~ 5,30 kg	105 kg
LELEE1146	ELEMENT-EL Baby 100	20	15	1250 x 1200 x 1150 mm		~ 6,00 kg	100 kg
LELEE1210	ELEMENT-EL Maxi 12	40	90	2500 x 900 x 620 mm		~ 3,30 kg	310 kg
LELEE1211	ELEMENT-EL Maxi 20	40	90	2500 x 900 x 920 mm		~ 3,50 kg	325 kg
LELEE1212	ELEMENT-EL Maxi 50	16	36	2500 x 900 x 920 mm		~ 4,40 kg	170 kg
LELEE1213	ELEMENT-EL Maxi 80	12	27	2500 x 900 x 1080 mm		~ 5,30 kg	160 kg
LELEE1214	ELEMENT-EL Maxi 100	10	22,50	2500 x 900 x 1150 mm		~ 6,00 kg	150 kg
LELEE2001	ELEMENT-SL 30	52	78	2500 x 1200 x 900 mm		~ 3,80 kg	300 kg
LELEE2003	ELEMENT-SL 50	32	48	2500 x 1200 x 920 mm		~ 4,40 kg	215 kg
LELEE2002	ELEMENT-SQ 30	52	78	2500 x 1200 x 900 mm		~ 3,80 kg	300 kg
LELEE2004	ELEMENT-SQ 50	32	48	2500 x 1200 x 920 mm		~ 4,40 kg	215 kg
LELEE3009	ELEMENT-VK Baby 6	160	120	1250 x 1200 x 600 mm		~ 3,30 kg	410 kg
LELEE3010	ELEMENT-VK Baby 12	80	60	1250 x 1200 x 630 mm		~ 3,90 kg	248 kg
LELEE3011	ELEMENT-VK Baby 20	80	60	1250 x 1200 x 950 mm		~ 4,10 kg	260 kg
LELEE3012	ELEMENT-VK Baby 30	52	39	1250 x 1200 x 930 mm		~ 4,30 kg	180 kg
LELEE3013	ELEMENT-VK Baby 50	32	24	1250 x 1200 x 950 mm		~ 4,75 kg	124 kg
LELEE3001	ELEMENT-VK 12	80	120	2500 x 1200 x 620 mm		~ 3,50 kg	450 kg
LELEE3002	ELEMENT-VK 20	80	120	2500 x 1200 x 920 mm	~ 4,10 kg	510 kg	
LELEE3003	ELEMENT-VK 30	52	78	2500 x 1200 x 900 mm	~ 4,10 kg	335 kg	
LELEE3005	ELEMENT-VK 50	32	48	2500 x 1200 x 950 mm	~ 4,40 kg	230 kg	

**LUX ELEMENTS®-FLOOR-WH**

see page 19

COLLECTIVE PACKAGING – PALLET PER PRODUCT							
ARTICLE-NUMBER	ARTICLE-NAME	PIECE/PALLET	m <sup>2</sup> /PALLET	PALLET DIMENSIONS LENGTH x WIDTH x HEIGHT	UNIT	WEIGHT/ UNIT	WEIGHT/ PALLET
LFLOOR1000	FLOOR-WH F 30-150	52	39	1250 x 1200 x 900 mm	m <sup>2</sup>	3,8 kg	160 kg
LFLOOR1001	FLOOR-WH F 50-150	32	24	1250 x 1200 x 920 mm		4,4 kg	115 kg
LFLOOR1002	FLOOR-WH F 30-100	52	39	1250 x 1200 x 900 mm		3,8 kg	160 kg
LFLOOR1003	FLOOR-WH F 50-100	32	24	1250 x 1200 x 920 mm		4,4 kg	115 kg

**LUX ELEMENTS®-TEC**

see page 33

INDIVIDUAL PACKAGING							
ARTICLE	CONTAINER	PACKAGING	UNIT	CONTENTS			
all	loose	carton or pallet	piece	singly by choice			
COLLECTIVE PACKAGING – PALLET PER PRODUCT							
ARTICLE-NUMBER	ARTICLE-NAME	PIECE/PALLET (P) PIECE/CARTON (K)	PALLET DIMENSIONS LENGTH x WIDTH x HEIGHT	UNIT	WEIGHT/ UNIT	WEIGHT/ PALLET/CARTON	
LTECX1001	TEC-KA 15 BS	60 (P)	2500 x 1200 x 630 mm	piece	2,65 kg	~ 180 kg	
LTECX1002	TEC-KA 20 BS	40 (P)	2500 x 1200 x 520 mm		3,50 kg	~ 160 kg	
LTECX1003	TEC-KA 30 BS	40 (P)	2500 x 1200 x 950 mm		5,00 kg	~ 220 kg	
LTECX1004	TEC-KA 40 BS	40 (P)	2500 x 1200 x 900 mm		5,00 kg	~ 220 kg	
LTECX1010	TEC-U 20 BS	5 (K)	2500 x 600 x 400 mm		6,00 kg	34 kg	
COLLECTIVE PACKAGING TEC-VWD							
ARTICLE-NUMBER	ARTICLE-NAME	PIECE/PALLET	PALLET DIMENSIONS – LENGTH x WIDTH x HEIGHT	UNIT	WEIGHT/CARTON	WEIGHT/PALLET	
LTECX5003	TEC-VWD-PS	40 pieces	1250 x 1200 x 520 mm	piece	2,20 kg	103 kg	
LTECX5004	TEC-VWD-E	40 pieces	1250 x 1200 x 920 mm		6,00 kg	255 kg	
LTECX5002	TEC-VWD-P	40 pieces	1250 x 1200 x 920 mm		5,8 kg	247 kg	
LTECX5005	TEC-VWD-PV	40 pieces	1250 x 1200 x 920 mm		6,00 kg	255 kg	

**LUX ELEMENTS®-TOP**

see page 35/37

INDIVIDUAL PACKAGING							
ARTICLE	CONTAINER	PACKAGING	UNIT	CONTENTS			
all	loose	carton or pallet	piece	singly by choice			
COLLECTIVE PACKAGING							
ARTICLE-NUMBER	ARTICLE-NAME	PIECE/PALLET PIECE/CARTON	PALLET DIMENSIONS LENGTH x WIDTH x HEIGHT	UNIT	WEIGHT/ UNIT	WEIGHT/ PALLET/CARTON	
LTOPE1002	TOP-TRS 1685 S	20	1800 x 600 x 750 mm	piece	3,50 kg	85 kg	
LTOPE1004	TOP-TRS 1785 S	20	1800 x 600 x 750 mm		4,15 kg	90 kg	
LTOPE1054	TOP-TRS 1860 S	20	2100 x 600 x 750 mm		4,60 kg	90 kg	
LTOPE1006	TOP-TRS 2100 S	20	2100 x 600 x 750 mm		5,20 kg	100 kg	
LTOPE1010	TOP-TRS 800 S	20	910 x 600 x 750 mm		1,70 kg	37 kg	
LTOPE1055	TOP-TRS 900 S	20	910 x 600 x 750 mm		1,95 kg	42 kg	
LTOPE1017	TOP-TRU 2100 S	6	2100 x 600 x 480 mm		5,25 kg	40 kg	
LTOPE1021	TOP-TRU 900 S	6	910 x 600 x 200 mm		2,20 kg	15 kg	
LTOPE1023	TOP-TRV 2100 S	6	2100 x 600 x 750 mm		5,40 kg	40 kg	
LTOPE1029	TOP-TRV 900 li S	6	1250 x 600 x 750 mm		1,95 kg	20 kg	
LTOPE1031	TOP-TRV 900 re S	6	1250 x 600 x 750 mm		1,95 kg	20 kg	
INDIVIDUAL PACKAGING TOP-KIT							
ARTICLE-NUMBER	ARTICLE-NAME	CONTAINER	PACKAGING	NOMINAL FORMATS/DIMENSIONS LENGTH x WIDTH x HEIGHT	UNIT	WEIGHT/ UNIT	WEIGHT/ PACKAGING
LTOPE1053	TOP-KIT	1 set	bag	485 x 275 x 160 mm	set	0,8 kg	0,8 kg

LUX ELEMENTS®-LAVADO

see page 41

INDIVIDUAL PACKAGING							
ARTICLE-NUMBER	ARTICLE-NAME	CONTAINER	PACKAGING	DIMENSIONS LENGTH x WIDTH x HEIGHT	UNIT	WEIGHT/ UNIT	WEIGHT/ CARTON
LLAVE5001	LAVADO-FLOAT G	1 set	carton	1210 x 605 x 120 mm	set	7,97 kg	9,74 kg
LLAVE5005	LAVADO-FLOAT L			1210 x 605 x 120 mm		10,00 kg	11,50 kg
OTHER ARTICLES ON REQUEST / COLLECTIVE PACKAGING ON REQUEST							

LUX ELEMENTS®-RELAX-NI

see page 45

INDIVIDUAL PACKAGING							
ARTICLE-NUMBER	ARTICLE-NAME	CONTAINER	PACKAGING	DIMENSIONS LENGTH x WIDTH x HEIGHT	UNIT	WEIGHT/ UNIT	WEIGHT/ CARTON
LREL8201	RELAX-NI-M	1 piece	carton	415 x 415 x 102 mm	piece	0,94 kg	2,50 kg
LREL8202	RELAX-NI-L			562 x 415 x 102 mm		1,35 kg	2,58 kg
LREL8203	RELAX-NI-XL			1075 x 415 x 102 mm		2,36 kg	3,50 kg
OTHER ARTICLES ON REQUEST / COLLECTIVE PACKAGING ON REQUEST							

LUX ELEMENTS®-RELAX-BA

see page 47/49/51/53/55

INDIVIDUAL PACKAGING										
ARTICLE-NUMBER	ARTICLE-NAME	CONTAINER	PACKAGING	DIMENSIONS LENGTH x WIDTH x HEIGHT	UNIT	WEIGHT/ UNIT	WEIGHT/ CARTON			
LREL8500	RELAX-BA SOLO 800	1 set	carton	800 x 450 x 280 mm	set	5,90 kg	6,90 kg			
LREL8501	RELAX-BA SOLO 900			900 x 450 x 280 mm		6,20 kg	7,40 kg			
LREL8502	RELAX-BA SOLO 1000			1000 x 450 x 280 mm		7,70 kg	9,10 kg			
LREL8503	RELAX-BA SHAPE 800			800 x 450 x 280 mm		5,90 kg	6,90 kg			
LREL8504	RELAX-BA SHAPE 900			900 x 450 x 280 mm		6,20 kg	7,40 kg			
LREL8505	RELAX-BA SHAPE 1000			1000 x 450 x 280 mm		7,70 kg	9,10 kg			
LREL8506	RELAX-BA SIZE 800			800 x 450 x 280 mm		5,90 kg	6,90 kg			
LREL8507	RELAX-BA SIZE 900			900 x 450 x 280 mm		6,20 kg	7,40 kg			
LREL8508	RELAX-BA SIZE 1000			1000 x 450 x 280 mm		7,70 kg	9,10 kg			
LREL8001	RELAX-BA-CO FLOAT S			615 x 105 x 305 mm		0,50 kg	0,68 kg			
LREL8002	RELAX-BA-CO FLOAT L			860 x 105 x 435 mm		1,00 kg	1,16 kg			
LREL8509	RELAX-BA FLOAT 800			800 x 450 x 100 mm		3,50 kg	4,50 kg			
LREL8510	RELAX-BA FLOAT 900			900 x 450 x 100 mm		3,85 kg	4,95 kg			
LREL8511	RELAX-BA FLOAT 1000			1000 x 450 x 100 mm		4,20 kg	5,40 kg			
LREL8550	RELAX-BA-L R 800			800 x 550 x 240 mm		4,80 kg	5,80 kg			
LREL8551	RELAX-BA-L R 900			900 x 550 x 240 mm		5,40 kg	6,60 kg			
LREL8552	RELAX-BA-L R 1000			1000 x 550 x 240 mm		6,00 kg	7,40 kg			
LREL8553	RELAX-BA-L E 800			800 x 550 x 240 mm		4,80 kg	5,80 kg			
LREL8554	RELAX-BA-L E 900			900 x 550 x 240 mm		5,40 kg	6,60 kg			
LREL8555	RELAX-BA-L E 1000			1000 x 550 x 240 mm		6,00 kg	7,40 kg			
LREL8512	RELAX-BA CUT-R 1200			1200 x 460 x 280 mm		8,30 kg	9,80 kg			
LREL8513	RELAX-BA CUT-E 1200			1200 x 460 x 280 mm		8,30 kg	9,80 kg			
LREL8556	RELAX-BA-L R 1200			1200 x 550 x 240 mm		7,20 kg	8,80 kg			
LREL8557	RELAX-BA-L E 1200			1200 x 550 x 240 mm		7,20 kg	8,80 kg			
COLLECTIVE PACKAGING ON REQUEST										

**LUX ELEMENTS®-RELAX-TW**

see page 57

INDIVIDUAL PACKAGING							
ARTICLE-NUMBER	ARTICLE-NAME	CONTAINER	PACKAGING	DIMENSIONS LENGTH x WIDTH x HEIGHT	UNIT	WEIGHT/ UNIT	WEIGHT/ CARTON
LREL9000	RELAX-TW 900	1 piece	carton	2520 x 920 x 120 mm	piece	13,50 kg	15,50 kg
LREL9001	RELAX-TW 1200			2520 x 1220 x 120 mm		18,00 kg	20,00 kg
COLLECTIVE PACKAGING ON REQUEST							

**LUX ELEMENTS®-TUB-COMBI(-S) MQ SET 300**

see page 67

INDIVIDUAL PACKAGING							
ARTICLE-NUMBER	ARTICLE-NAME	CONTAINER	PACKAGING	DIMENSIONS LENGTH x WIDTH x HEIGHT	UNIT	WEIGHT/ UNIT	WEIGHT/ CARTON
LTUBE19003	TUB-COMBI MQ SET 300	1 set	carton	310 x 305 x 100 mm	piece	0,95 kg	1,30 kg
LTUBE19325	TUB-COMBI-S MQ SET 300	1 set	carton	310 x 305 x 90 mm	piece	0,65 kg	1,00 kg
COLLECTIVE PACKAGING ON REQUEST							

**LUX ELEMENTS®-TUB-MQ SET 300**

see page 67

INDIVIDUAL PACKAGING							
ARTICLE-NUMBER	ARTICLE-NAME	CONTAINER	PACKAGING	DIMENSIONS LENGTH x WIDTH x HEIGHT	UNIT	WEIGHT/ UNIT	WEIGHT/ CARTON
LTUBE1111	TUB-MQ-SET 300	1 set	carton	340 x 310 x 120 mm	piece	0,55 kg	0,90 kg
COLLECTIVE PACKAGING ON REQUEST							

**LUX ELEMENTS®-TUB-LINE COMBI (V) RT / GK**

see page 69/71

INDIVIDUAL PACKAGING							
ARTICLE-NUMBER	ARTICLE-NAME	CONTAINER	PACKAGING	DIMENSIONS LENGTH x WIDTH x HEIGHT	UNIT	WEIGHT/ UNIT	WEIGHT/ CARTON
LTUBE9316	TUB-LINE COMBI RT 900 (650)	1 piece	carton	1255 x 218 x 121 mm	piece	2,60 kg	3,40 kg
LTUBE9306	TUB-LINE COMBI RT 900 (750)			1255 x 218 x 121 mm		2,70 kg	3,50 kg
LTUBE9308	TUB-LINE COMBI RT 1200 (850)			1255 x 218 x 121 mm		3,30 kg	4,10 kg
LTUBE98303	TUB-LINE COMBI V RT 800 (650)			1255 x 218 x 121 mm		3,40 kg	4,40 kg
LTUBE98304	TUB-LINE COMBI V RT 900 (650)			1255 x 218 x 121 mm		3,70kg	4,50 kg
LTUBE98301	TUB-LINE COMBI V RT 1000 (650)			1055 x 218 x 121 mm		4,60 kg	5,40 kg
LTUBE98305	TUB-LINE COMBI V RT 1100 (650)			1255 x 218 x 121 mm		5,10 kg	5,90 kg
LTUBE98302	TUB-LINE COMBI V RT 1200 (850)			1255 x 218 x 121 mm		5,30 kg	6,10 kg
LTUBE98306	TUB-LINE COMBI V RT 1800 (850)			1855 x 218 x 121 mm		8,50 kg	9,50 kg
LTUBE9345	TUB-LINE COMBI GK Q1 800			835 x 815 x 115 mm		8,80 kg	11,60 kg
LTUBE9346	TUB-LINE COMBI GK Q1 900			935 x 935 x 115 mm		9,90 kg	13,05 kg
LTUBE9305	TUB-LINE COMBI GK Q1 1000			1035 x 1015 x 115 mm		11,00 kg	14,50 kg
LTUBE9347	TUB-LINE COMBI GK Q1 1100			1135 x 1115 x 115 mm		12,10 kg	15,95 kg
LTUBE9309	TUB-LINE COMBI GK Q1 1200			1235 x 1215 x 115 mm		11,80 kg	15,05 kg
LTUBE9348	TUB-LINE COMBI GK R1 1000/1800			1035 x 1815 x 115 mm		19,44 kg	24,95 kg
LTUBE9307	TUB-LINE COMBI GK R1 1200/900			1250 x 910 x 115 mm		9,70 kg	11,60 kg
COLLECTIVE PACKAGING ON REQUEST							

LUX ELEMENTS®-TUB-LINE (V) RT / GK

see page 73/75

INDIVIDUAL PACKAGING							
ARTICLE-NUMBER	ARTICLE-NAME	CONTAINER	PACKAGING	DIMENSIONS LENGTH x WIDTH x HEIGHT	UNIT	WEIGHT/ UNIT	WEIGHT/ CARTON
LTUBE95008	TUB-LINE RT 900/200 (650)	1 set	carton	1255 x 218 x 121 mm	set	2,70 kg	3,50 kg
LTUBE95001	TUB-LINE RT 900/200 (750)	1 set		1255 x 218 x 121 mm	set	2,70 kg	3,50 kg
LTUBE95003	TUB-LINE RT 1200/200 (850)	1 set		1255 x 218 x 121 mm	set	3,30 kg	4,10 kg
LTUBE98200	TUB-LINE V RT 800/200 (650)	1 set		1255 x 218 x 121 mm	set	3,40 kg	4,40 kg
LTUBE98203	TUB-LINE V RT 900/200 (650)	1 set		1255 x 218 x 121 mm	set	3,70 kg	4,50 kg
LTUBE98201	TUB-LINE V RT 1000/200 (650)	1 set		1055 x 218 x 121 mm	set	4,60 kg	5,40 kg
LTUBE98204	TUB-LINE V RT 1100/200 (650)	1 set		1255 x 218 x 121 mm	set	5,10 kg	5,90 kg
LTUBE98202	TUB-LINE V RT 1200/200 (850)	1 set		1255 x 218 x 121 mm	set	5,30 kg	6,10 kg
LTUBE98205	TUB-LINE V RT 1800/200 (850)	1 set		1855 x 218 x 121 mm	set	8,50 kg	9,50 kg
LTUBE95011	TUB-LINE GK Q1 800	1 piece		835 x 815 x 60 mm	piece	8,40 kg	11,85 kg
LTUBE95012	TUB-LINE GK Q1 900	1 piece		935 x 915 x 60 mm	piece	9,45 kg	12,70 kg
LTUBE95009	TUB-LINE GK Q1 1000	1 piece		1035 x 1015 x 60 mm	piece	10,50 kg	13,75 kg
LTUBE95013	TUB-LINE GK Q1 1100	1 piece		1135 x 1115 x 60 mm	piece	11,55 kg	14,80 kg
LTUBE95004	TUB-LINE GK Q1 1200	1 piece		1235 x 1215 x 115 mm	piece	11,50 kg	14,75 kg
LTUBE95010	TUB-LINE GK R1 1000/1800	1 piece		1835 x 1015 x 60 mm	piece	19,44 kg	24,75 kg
LTUBE95002	TUB-LINE GK R1 1200/900	1 piece		1250 x 910 x 60 mm	piece	9,50 kg	11,40 kg
LTUBE11110	TUB-UQ 800	1 piece		845 x 820 x 60 mm	piece	1,00 kg	2,00 kg
LTUBE11111	TUB-UQ 900	1 piece		945 x 920 x 60 mm	piece	1,10 kg	2,08 kg
LTUBE11112	TUB-UQ 1000	1 piece		1045 x 1020 x 60 mm	piece	1,36 kg	3,25 kg
LTUBE11115	TUB-UQ 1100	1 piece		1145 x 1120 x 60 mm	piece	1,63 kg	2,84 kg
LTUBE11113	TUB-UQ 1200	1 piece		1235 x 1215 x 60 mm	piece	1,96 kg	3,70 kg
LTUBE11812	TUB-UR 1200/900	1 piece		1250 x 910 x 60 mm	piece	1,47 kg	2,99 kg
LTUBE98101	TUB-UBOL 1800/1000	1 piece		1850 x 1010 x 60 mm	piece	2,50 kg	5,50 kg

COLLECTIVE PACKAGING ON REQUEST

LUX ELEMENTS®-TUB-COMBI-S

see page 81

INDIVIDUAL PACKAGING							
ARTICLE-NUMBER	ARTICLE-NAME	CONTAINER	PACKAGING	DIMENSIONS LENGTH x WIDTH x HEIGHT	UNIT	WEIGHT/ UNIT	WEIGHT/ CARTON
LTUBE19302	TUB-COMBI-S MQ 800	1 piece	carton	845 x 820 x 80 mm	piece	3,95 kg	5,00 kg
LTUBE19300	TUB-COMBI-S MQ 900			945 x 920 x 100 mm		5,55 kg	7,10 kg
LTUBE19301	TUB-COMBI-S MQ 1000			1045 x 1020 x 100 mm		7,35 kg	9,50 kg
LTUBE19303	TUB-COMBI-S MQ1100			1145 x 1120 x 80 mm		7,50 kg	9,40 kg
LTUBE19304	TUB-COMBI-S MQ 1200			1245 x 1220 x 80 mm		8,95 kg	10,90 kg
LTUBE19305	TUB-COMBI-S ER 900/800			950 x 810 x 80 mm		4,45 kg	5,50 kg
LTUBE19306	TUB-COMBI-S ER 1000/800			1050 x 810 x 80 mm		5,00 kg	6,10 kg
LTUBE19307	TUB-COMBI-S ER 1100/800			1150 x 810 x 80 mm		5,45 kg	6,60 kg
LTUBE19308	TUB-COMBI-S ER 1200/800			1250 x 810 x 80 mm		6,00 kg	7,30 kg
LTUBE19309	TUB-COMBI-S ER 1000/900			1050 x 910 x 80 mm		5,60 kg	6,70 kg
LTUBE19310	TUB-COMBI-S ER 1100/900			1150 x 910 x 80 mm		6,20 kg	7,40 kg
LTUBE19311	TUB-COMBI-S ER 1200/900			1250 x 910 x 80 mm		6,70 kg	8,20 kg
LTUBE19312	TUB-COMBI-S ER 1300/900			1350 x 910 x 80 mm		7,25 kg	8,50 kg
LTUBE19313	TUB-COMBI-S ER 1400/900			1450 x 910 x 80 mm		7,80 kg	9,30 kg
LTUBE19314	TUB-COMBI-S ER 1500/900			1550 x 910 x 80 mm		8,40 kg	10,00 kg
LTUBE19315	TUB-COMBI-S ER 1600/900			1650 x 910 x 80 mm		8,95 kg	10,60 kg
LTUBE19316	TUB-COMBI-S ER 1100/1000			1150 x 1010 x 80 mm		6,80 kg	8,70 kg
LTUBE19317	TUB-COMBI-S ER 1200/1000			1250 x 1010 x 80 mm		7,45 kg	9,00 kg
LTUBE19318	TUB-COMBI-S ER 1300/1000			1350 x 1010 x 80 mm		8,00 kg	9,60 kg
LTUBE19319	TUB-COMBI-S ER 1400/1000			1450 x 1010 x 80 mm		8,70 kg	10,40 kg
LTUBE19320	TUB-COMBI-S ER 1500/1000			1550 x 1010 x 80 mm		9,30 kg	11,10 kg
LTUBE19321	TUB-COMBI-S ER 1600/1000			1650 x 1010 x 80 mm		9,90 kg	11,80 kg

COLLECTIVE PACKAGING ON REQUEST

**LUX ELEMENTS®-TUB-COMBI-S BOL**

see page 83

INDIVIDUAL PACKAGING							
ARTICLE-NUMBER	ARTICLE-NAME	CONTAINER	PACKAGING	DIMENSIONS LENGTH x WIDTH x HEIGHT	UNIT	WEIGHT/ UNIT	WEIGHT/ CARTON
LTUBE19322	TUB-COMBI-S BOL 1800/800	1 piece	carton	1850 x 810 x 80 mm	piece	8,95 kg	11,00 kg
LTUBE19323	TUB-COMBI-S BOL 1800/900			1850 x 910 x 80 mm		10,00 kg	12,10 kg
LTUBE19324	TUB-COMBI-S BOL 1800/1000			1850 x 1010 x 80 mm		11,20 kg	13,40 kg
<b>COLLECTIVE PACKAGING ON REQUEST</b>							

**LUX ELEMENTS®-TUB-PUMP**

see page 85

INDIVIDUAL PACKAGING										
ARTICLE-NUMBER	ARTICLE-NAME	CONTAINER	PACKAGING	DIMENSIONS LENGTH x WIDTH x HEIGHT	UNIT	WEIGHT/ UNIT	WEIGHT/ CARTON			
LTUBE19209	TUB-PUMP S MQ 800	1 set	carton	845 x 820 x 125 mm	set	6,80 kg	8,20 kg			
LTUBE19205	TUB-PUMP-S MQ 900			945 x 920 x 125 mm		8,60 kg	10,40 kg			
LTUBE19210	TUB-PUMP S MQ 1000			1045 x 1020 x 125 mm		10,60 kg	12,80 kg			
LTUBE19211	TUB-PUMP S MQ1100			1145 x 1120 x 125 mm		12,85 kg	15,50 kg			
LTUBE19206	TUB-PUMP-S MQ 1200			1245 x 1220 x 125 mm		15,30 kg	18,50 kg			
LTUBE19212	TUB-PUMP S MR 900/800			950 x 810 x 125 mm		7,65 kg	9,25 kg			
LTUBE19213	TUB-PUMP S MR 1000/800			1050 x 810 x 125 mm		8,50 kg	10,25 kg			
LTUBE19214	TUB-PUMP S MR 1100/800			1150 x 810 x 125 mm		9,35 kg	11,30 kg			
LTUBE19215	TUB-PUMP S MR 1200/800			1250 x 810 x 125 mm		10,20 kg	12,30 kg			
LTUBE19216	TUB-PUMP S MR 1000/900			1050 x 910 x 125 mm		9,60 kg	11,55 kg			
LTUBE19217	TUB-PUMP S MR 1100/900			1150 x 910 x 125 mm		10,50 kg	12,70 kg			
LTUBE19207	TUB-PUMP-S MR 1200/900			1250 x 910 x 125 mm		11,50 kg	13,85 kg			
LTUBE19218	TUB-PUMP S MR 1300/900			1350 x 910 x 125 mm		12,40 kg	15,00 kg			
LTUBE19208	TUB-PUMP-S MR 1400/900			1450 x 910 x 125 mm		13,40 kg	16,15 kg			
LTUBE19219	TUB-PUMP S MR 1500/900			1550 x 910 x 125 mm		14,30 kg	17,30 kg			
LTUBE19220	TUB-PUMP S MR 1600/900			1650 x 910 x 125 mm		15,30 kg	18,45kg			
LTUBE19221	TUB-PUMP S MR 1100/1000			1150 x 1010 x 125 mm		11,70 kg	14,10 kg			
LTUBE19222	TUB-PUMP S MR 1200/1000			1250 x 1010 x 125 mm		12,75 kg	15,40 kg			
LTUBE19223	TUB-PUMP S MR 1300/1000			1350 x 1010 x 125 mm		13,80 kg	16,70 kg			
LTUBE19224	TUB-PUMP M ER 1400/1000			1450 x 1010 x 125 mm		14,90 kg	17,95 kg			
LTUBE19225	TUB-PUMP S MR 1500/1000			1550 x 1010 x 125 mm		15,95 kg	19,25 kg			
LTUBE19226	TUB-PUMP S MR 1600/1000			1650 x 1010 x 125 mm		17,00 kg	20,50 kg			
<b>COLLECTIVE PACKAGING ON REQUEST</b>										

LUX ELEMENTS®-TUB-LINE COMBI

see page 87

INDIVIDUAL PACKAGING							
ARTICLE-NUMBER	ARTICLE-NAME	CONTAINER	PACKAGING	DIMENSIONS LENGTH x WIDTH x HEIGHT	UNIT	WEIGHT/ UNIT	WEIGHT/ CARTON
LTUBE9324	TUB-LINE COMBI Q1 800	1 set	carton	845 x 820 x 100 mm	set	6,10 kg	6,90 kg
LTUBE9322	TUB-LINE COMBI Q1 900			945 x 920 x 100 mm		7,70 kg	8,70 kg
LTUBE9325	TUB-LINE COMBI Q1 1000			1045 x 1020 x 100 mm		9,50kg	10,75 kg
LTUBE9326	TUB-LINE COMBI Q1 1100			1145 x 1120 x 100 mm		11,50 kg	13,00 kg
LTUBE9327	TUB-LINE COMBI Q1 1200			1245 x 1220 x 100 mm		13,70 kg	15,45 kg
LTUBE9328	TUB-LINE COMBI R1 900/800			950 x 810 x 100 mm		6,90 kg	7,75 kg
LTUBE9329	TUB-LINE COMBI R1 1000/800			1050 x 810 x 100 mm		7,60 kg	8,60 kg
LTUBE9334	TUB-LINE COMBI R1 1100/800			1150 x 810 x 100 mm		8,40 kg	9,45 kg
LTUBE9335	TUB-LINE COMBI R1 1200/800			1250 x 810 x 100 mm		9,15 kg	10,30 kg
LTUBE9336	TUB-LINE COMBI R1 1000/900			1050 x 910 x 100 mm		8,60 kg	9,65 kg
LTUBE9337	TUB-LINE COMBI R1 1100/900			1150 x 910 x 100 mm		9,45 kg	10,65 kg
LTUBE9323	TUB-LINE COMBI R1 1200/900			1250 x 910 x 100 mm		10,30 kg	11,60 kg
LTUBE9338	TUB-LINE COMBI R1 1100/1000			1150 x 1010 x 100 mm		10,50 kg	11,80 kg
LTUBE9339	TUB-LINE COMBI R1 1200/1000			1250 x 1010 x 100 mm		11,45 kg	12,90 kg

COLLECTIVE PACKAGING ON REQUEST

LUX ELEMENTS®-TUB-EQ

see page 93

INDIVIDUAL PACKAGING							
ARTICLE-NUMBER	ARTICLE-NAME	CONTAINER	PACKAGING	DIMENSIONS LENGTH x WIDTH x HEIGHT	UNIT	WEIGHT/ UNIT	WEIGHT/ CARTON
LTUBE10000	TUB-EQ 800	1 piece	carton	845 x 820 x 60 mm	piece	5,00 kg	6,00 kg
LTUBE10001	TUB-EQ 900			945 x 920 x 60 mm		5,50 kg	6,48 kg
LTUBE10002	TUB-EQ 1000			1045 x 1020 x 60 mm		6,79 kg	8,69 kg
LTUBE10009	TUB-EQ 1100			1145 x 1120 x 60 mm		8,25 kg	9,30 kg
LTUBE10003	TUB-EQ 1200			1235 x 1215 x 60 mm		9,78 kg	11,52 kg
LTUBE10004	TUB-EQ 1500			1535 x 1515 x 60 mm		15,28 kg	18,93 kg

COLLECTIVE PACKAGING ON REQUEST

LUX ELEMENTS®-TUB-MQ

see page 93

INDIVIDUAL PACKAGING							
ARTICLE-NUMBER	ARTICLE-NAME	CONTAINER	PACKAGING	DIMENSIONS LENGTH x WIDTH x HEIGHT	UNIT	WEIGHT/ UNIT	WEIGHT/ CARTON
LTUBE10100	TUB-MQ 800	1 piece	carton	845 x 820 x 60 mm	piece	5,00 kg	6,00 kg
LTUBE10101	TUB-MQ 900			945 x 920 x 60 mm		5,50 kg	6,48 kg
LTUBE10102	TUB-MQ 1000			1045 x 1020 x 60 mm		6,79 kg	8,69 kg
LTUBE10109	TUB-MQ 1100			1145 x 1120 x 60 mm		8,25 kg	9,30 kg
LTUBE10103	TUB-MQ 1200			1235 x 1215 x 60 mm		9,78 kg	11,52 kg
LTUBE10104	TUB-MQ 1500			1535 x 1515 x 60 mm		15,28 kg	18,93 kg

COLLECTIVE PACKAGING ON REQUEST



**LUX ELEMENTS®-TUB-ER**

see page 94

INDIVIDUAL PACKAGING										
ARTICLE-NUMBER	ARTICLE-NAME	CONTAINER	PACKAGING	DIMENSIONS LENGTH x WIDTH x HEIGHT	UNIT	WEIGHT/ UNIT	WEIGHT/ CARTON			
LTUBE10616	TUB-ER 900/800	1 piece	carton	950 x 810 x 60 mm	piece	4,90 kg	5,55 kg			
LTUBE10614	TUB-ER 1000/800			1050 x 810 x 60 mm		5,45 kg	6,15 kg			
LTUBE10617	TUB-ER 1100/800			1150 x 810 x 60 mm		6,00 kg	6,75 kg			
LTUBE10618	TUB-ER 1200/800			1250 x 810 x 60 mm		6,50 kg	7,40 kg			
LTUBE10619	TUB-ER 1000/900			1050 x 910 x 60 mm		6,10 kg	6,90 kg			
LTUBE10620	TUB-ER 1100/900			1150 x 910 x 60 mm		6,70 kg	7,60 kg			
LTUBE10601	TUB-ER 1200/900			1250 x 910 x 60 mm		7,35 kg	8,30 kg			
LTUBE10615	TUB-ER 1300/900			1350 x 910 x 60 mm		7,95 kg	9,00 kg			
LTUBE10603	TUB-ER 1400/900			1450 x 910 x 60 mm		8,55 kg	9,70 kg			
LTUBE10604	TUB-ER 1500/900			1550 x 910 x 60 mm		9,15 kg	10,40 kg			
LTUBE10605	TUB-ER 1600/900			1650 x 910 x 60 mm		9,80 kg	11,10 kg			
LTUBE10621	TUB-ER 1100/1000			1150 x 1010 x 60 mm		7,45 kg	8,45 kg			
LTUBE10602	TUB-ER 1200/1000			1250 x 1010 x 60 mm		8,15 kg	9,25 kg			
LTUBE10622	TUB-ER 1300/1000			1350 x 1010 x 60 mm		8,85 kg	10,00 kg			
LTUBE10623	TUB-ER 1400/1000			1450 x 1010 x 60 mm		9,50 kg	10,80 kg			
LTUBE10624	TUB-ER 1500/1000			1550 x 1010 x 60 mm		10,20 kg	11,55 kg			
LTUBE10625	TUB-ER 1600/1000			1650 x 1010 x 60 mm		10,85 kg	12,30 kg			
<b>COLLECTIVE PACKAGING ON REQUEST</b>										

**LUX ELEMENTS®-TUB-MR**

see page 95

INDIVIDUAL PACKAGING										
ARTICLE-NUMBER	ARTICLE-NAME	CONTAINER	PACKAGING	DIMENSIONS LENGTH x WIDTH x HEIGHT	UNIT	WEIGHT/ UNIT	WEIGHT/ CARTON			
LTUBE10719	TUB-MR 900/800	1 piece	carton	950 x 810 x 60 mm	piece	4,90 kg	5,55 kg			
LTUBE10701	TUB-MR 1000/800			1050 x 810 x 60 mm		5,45 kg	6,15 kg			
LTUBE10720	TUB-MR 1100/800			1150 x 810 x 60 mm		6,00 kg	6,75 kg			
LTUBE10718	TUB-MR 1200/800			1250 x 810 x 60 mm		6,50 kg	7,40 kg			
LTUBE10721	TUB-MR 1000/900			1050 x 910 x 60 mm		6,10 kg	6,90 kg			
LTUBE10722	TUB-MR 1100/900			1150 x 910 x 60 mm		6,70 kg	7,60 kg			
LTUBE10702	TUB-MR 1200/900			1250 x 910 x 60 mm		7,35 kg	8,30 kg			
LTUBE10717	TUB-MR 1300/900			1350 x 910 x 60 mm		7,95 kg	9,00 kg			
LTUBE10704	TUB-MR 1400/900			1450 x 910 x 60 mm		8,55 kg	10,70 kg			
LTUBE10705	TUB-MR 1500/900			1550 x 910 x 60 mm		9,15 kg	10,40 kg			
LTUBE10706	TUB-MR 1600/900			1650 x 910 x 60 mm		9,80 kg	11,10 kg			
LTUBE10723	TUB-MR 1100/1000			1150 x 1010 x 60 mm		7,45 kg	8,45 kg			
LTUBE10703	TUB-MR 1200/1000			1250 x 1010 x 60 mm		8,15 kg	9,25 kg			
LTUBE10724	TUB-MR 1300/1000			1350 x 1010 x 60 mm		8,85 kg	10,00 kg			
LTUBE10725	TUB-MR 1400/1000			1450 x 1010 x 60 mm		9,50 kg	10,80 kg			
LTUBE10726	TUB-MR 1500/1000			1550 x 1010 x 60 mm		10,20 kg	11,55 kg			
LTUBE10727	TUB-MR 1600/1000			1650 x 1010 x 60 mm		10,85 kg	12,30 kg			
<b>COLLECTIVE PACKAGING ON REQUEST</b>										

**LUX ELEMENTS®-TUB-BOL**

see page 97

INDIVIDUAL PACKAGING							
ARTICLE-NUMBER	ARTICLE-NAME	CONTAINER	PACKAGING	DIMENSIONS LENGTH x WIDTH x HEIGHT	UNIT	WEIGHT/ UNIT	WEIGHT/ CARTON
LTUBE18026	TUB-BOL 1800/800	1 piece	carton	1850 x 810 x 60 mm	piece	9,80 kg	11,10 kg
LTUBE18018	TUB-BOL 1800/900			1850 x 910 x 60 mm		11,00 kg	12,45 kg
LTUBE18027	TUB-BOL 1800/1000			1850 x 1010 x 60 mm		12,20 kg	13,85 kg
COLLECTIVE PACKAGING ON REQUEST							

**LUX ELEMENTS®-TUB-FINISH**

see page 99

INDIVIDUAL PACKAGING							
ARTICLE-NUMBER	ARTICLE-NAME	CONTAINER	PACKAGING	DIMENSIONS LENGTH x WIDTH x HEIGHT	UNIT	WEIGHT/ UNIT	WEIGHT/ CARTON
LTUBE10101.FW	TUB-FW MQ 900	1 piece	carton	945 x 920 x 100 mm	piece	16,00 kg	18,00 kg
LTUBE10601.FW	TUB-FW ER 1200/900			1250 x 920 x 100 mm		22,80 kg	24,80 kg
LTUBE10605.FW	TUB-FW ER 1600/900			1650 x 920 x 100 mm		29,30 kg	31,30 kg
COLLECTIVE PACKAGING ON REQUEST							

**LUX ELEMENTS®-TUB-LINE Q4/Q1**

see page 101

INDIVIDUAL PACKAGING										
ARTICLE-NUMBER	ARTICLE-NAME	CONTAINER	PACKAGING	DIMENSIONS LENGTH x WIDTH x HEIGHT	UNIT	WEIGHT/ UNIT	WEIGHT/ CARTON			
LTUBE94033	TUB-LINE Q4 800	1 piece	carton	845 x 820 x 60 mm	piece	5,30 kg	6,10 kg			
LTUBE94001	TUB-LINE Q4 900			945 x 920 x 60 mm		6,72 kg	7,70 kg			
LTUBE94017	TUB-LINE Q4 1000			1045 x 1020 x 60 mm		8,3 kg	9,51 kg			
LTUBE94037	TUB-LINE Q4 1100			1145 x 1120 x 60 mm		10,00 kg	11,50 kg			
LTUBE94019	TUB-LINE Q4 1200			1235 x 1215 x 60 mm		11,11 kg	12,85 kg			
LTUBE94034	TUB-LINE Q1 800			845 x 820 x 60 mm		5,30 kg	6,10 kg			
LTUBE94002	TUB-LINE Q1 900			945 x 920 x 60 mm		6,72 kg	7,70 kg			
LTUBE94018	TUB-LINE Q1 1000			1045 x 1020 x 60 mm		8,3 kg	9,51 kg			
LTUBE94038	TUB-LINE Q1 1100			1145 x 1120 x 60 mm		10,00 kg	11,50 kg			
LTUBE94020	TUB-LINE Q1 1200			1235 x 1215 x 60 mm		11,11 kg	12,85 kg			
COLLECTIVE PACKAGING ON REQUEST										

**LUX ELEMENTS®-TUB-LINE R4**

see page 102

INDIVIDUAL PACKAGING							
ARTICLE-NUMBER	ARTICLE-NAME	CONTAINER	PACKAGING	DIMENSIONS LENGTH x WIDTH x HEIGHT	UNIT	WEIGHT/ UNIT	WEIGHT/ CARTON
LTUBE94039	TUB-LINE R4 900/800	1 piece	carton	950 x 810 x 60 mm	piece	6,00 kg	6,85 kg
LTUBE94041	TUB-LINE R4 1000/800			1050 x 810 x 60 mm		6,65 kg	7,60 kg
LTUBE94043	TUB-LINE R4 1100/800			1150 x 810 x 60 mm		7,30 kg	8,35 kg
LTUBE94045	TUB-LINE R4 1200/800			1250 x 810 x 60 mm		8,00 kg	9,10 kg
LTUBE94047	TUB-LINE R4 1000/900			1050 x 910 x 60 mm		7,45 kg	8,55 kg
LTUBE94049	TUB-LINE R4 1100/900			1150 x 910 x 60 mm		8,20 kg	9,40 kg
LTUBE94003	TUB-LINE R4 1200/900			1250 x 910 x 60 mm		9,00 kg	10,25 kg
LTUBE94051	TUB-LINE R4 1300/900			1350 x 910 x 60 mm		9,70 kg	11,10 kg
LTUBE94005	TUB-LINE R4 1400/900			1450 x 910 x 60 mm		10,45 kg	12,00 kg
LTUBE94053	TUB-LINE R4 1500/900			1550 x 910 x 60 mm		11,20 kg	12,85 kg
LTUBE94007	TUB-LINE R4 1600/900			1650 x 910 x 60 mm		11,95 kg	13,70 kg
LTUBE94055	TUB-LINE R4 1100/1000			1150 x 1010 x 60 mm		9,15 kg	10,45 kg
LTUBE94021	TUB-LINE R4 1200/1000			1250 x 1010 x 60 mm		9,95 kg	11,40 kg
LTUBE94057	TUB-LINE R4 1300/1000			1350 x 1010 x 60 mm		10,80 kg	12,35 kg
LTUBE94059	TUB-LINE R4 1400/1000			1450 x 1010 x 60 mm		11,60 kg	13,30 kg
LTUBE94061	TUB-LINE R4 1500/1000			1550 x 1010 x 60 mm		12,45 kg	14,25 kg
LTUBE94063	TUB-LINE R4 1600/1000			1650 x 1010 x 60 mm		13,30 kg	15,20 kg
<b>COLLECTIVE PACKAGING ON REQUEST</b>							

**LUX ELEMENTS®-TUB-LINE R1**

see page 104

INDIVIDUAL PACKAGING							
ARTICLE-NUMBER	ARTICLE-NAME	CONTAINER	PACKAGING	DIMENSIONS LENGTH x WIDTH x HEIGHT	UNIT	WEIGHT/ UNIT	WEIGHT/ CARTON
LTUBE94040	TUB-LINE R1 900/800	1 piece	carton	950 x 810 x 60 mm	piece	6,00 kg	6,85 kg
LTUBE94042	TUB-LINE R1 1000/800			1050 x 810 x 60 mm		6,65 kg	7,60 kg
LTUBE94044	TUB-LINE R1 1100/800			1150 x 810 x 60 mm		7,30 kg	8,35 kg
LTUBE94046	TUB-LINE R1 1200/800			1250 x 810 x 60 mm		8,00 kg	9,10 kg
LTUBE94048	TUB-LINE R1 1000/900			1050 x 910 x 60 mm		7,45 kg	8,55 kg
LTUBE94050	TUB-LINE R1 1100/900			1150 x 910 x 60 mm		8,20 kg	9,40 kg
LTUBE94004	TUB-LINE R1 1200/900			1250 x 910 x 60 mm		9,00 kg	10,25 kg
LTUBE94052	TUB-LINE R1 1300/900			1350 x 910 x 60 mm		9,70 kg	11,10 kg
LTUBE94006	TUB-LINE R1 1400/900			1450 x 910 x 60 mm		10,45 kg	12,00 kg
LTUBE94054	TUB-LINE R1 1500/900			1550 x 910 x 60 mm		11,20 kg	12,85 kg
LTUBE94008	TUB-LINE R1 1600/900			1650 x 910 x 60 mm		11,95 kg	13,70 kg
LTUBE94056	TUB-LINE R1 1100/1000			1150 x 1010 x 60 mm		9,15 kg	10,45 kg
LTUBE94022	TUB-LINE R1 1200/1000			1250 x 1010 x 60 mm		9,95 kg	11,40 kg
LTUBE94058	TUB-LINE R1 1300/1000			1350 x 1010 x 60 mm		10,80 kg	12,35 kg
LTUBE94060	TUB-LINE R1 1400/1000			1450 x 1010 x 60 mm		11,60 kg	13,30 kg
LTUBE94062	TUB-LINE R1 1500/1000			1550 x 1010 x 60 mm		12,45 kg	14,25 kg
LTUBE94064	TUB-LINE R1 1600/1000			1650 x 1010 x 60 mm		13,30 kg	15,20 kg
<b>COLLECTIVE PACKAGING ON REQUEST</b>							

LUX ELEMENTS®-TUB-LINE BOL

see page 107

INDIVIDUAL PACKAGING							
ARTICLE-NUMBER	ARTICLE-NAME	CONTAINER	PACKAGING	DIMENSIONS LENGTH x WIDTH x HEIGHT	UNIT	WEIGHT/ UNIT	WEIGHT/ CARTON
LTUBE97003	TUB-LINE BOL 1800/800	1 piece	carton	1850 x 810 x 60 mm	piece	11,95 kg	13,70 kg
LTUBE97001	TUB-LINE BOL 1800/900			1850 x 910 x 60 mm		13,45 kg	15,40 kg
LTUBE97005	TUB-LINE BOL 1800/1000			1850 x 1010 x 60 mm		14,95 kg	17,10 kg
COLLECTIVE PACKAGING ON REQUEST							

LUX ELEMENTS®-TUB-LINE V

see page 109

INDIVIDUAL PACKAGING										
ARTICLE-NUMBER	ARTICLE-NAME	CONTAINER	PACKAGING	DIMENSIONS LENGTH x WIDTH x HEIGHT	UNIT	WEIGHT/ UNIT	WEIGHT/ CARTON			
LTUBE98010	TUB-LINE V Q1 800	1 piece	carton	850 x 810 x 60 mm	piece	5,30 kg	6,10 kg			
LTUBE98011	TUB-LINE V Q1 900			950 x 910 x 60 mm		6,70 kg	7,70 kg			
LTUBE98012	TUB-LINE V Q1 1000			1050 x 1010 x 60 mm		8,30 kg	9,50 kg			
LTUBE98013	TUB-LINE V Q1 1100			1150 x 1110 x 60 mm		10,00 kg	11,50 kg			
LTUBE98014	TUB-LINE V Q1 1200			1250 x 1210 x 60 mm		11,95 kg	13,70 kg			
LTUBE98015	TUB-LINE V R1 900/800			950 x 810 x 60 mm		6,00 kg	6,85 kg			
LTUBE98016	TUB-LINE V R1 1000/800			1050 x 810 x 60 mm		6,65 kg	7,60 kg			
LTUBE98017	TUB-LINE V R1 1100/800			1150 x 810 x 60 mm		7,30 kg	8,35 kg			
LTUBE98018	TUB-LINE V R1 1200/800			1250 x 810 x 60 mm		8,00 kg	9,10 kg			
LTUBE98019	TUB-LINE V R1 1000/900			1050 x 910 x 60 mm		7,50 kg	8,55 kg			
LTUBE98020	TUB-LINE V R1 1100/900			1150 x 910 x 60 mm		8,20 kg	9,40 kg			
LTUBE98021	TUB-LINE V R1 1200/900			1250 x 910 x 60 mm		8,95 kg	10,25 kg			
LTUBE98022	TUB-LINE V R1 1300/900			1350 x 910 x 60 mm		9,70 kg	11,10 kg			
LTUBE98023	TUB-LINE V R1 1400/900			1450 x 910 x 60 mm		10,45 kg	11,95 kg			
LTUBE98024	TUB-LINE V R1 1500/900			1550 x 910 x 60 mm		11,20 kg	12,85 kg			
LTUBE98025	TUB-LINE V R1 1600/900			1650 x 910 x 60 mm		11,95 kg	13,70 kg			
LTUBE98026	TUB-LINE V R1 1100/1000			1150 x 1010 x 60 mm		9,15 kg	10,45 kg			
LTUBE98027	TUB-LINE V R1 1200/1000			1250 x 1010 x 60 mm		9,95 kg	11,40 kg			
LTUBE98028	TUB-LINE V R1 1300/1000			1350 x 1010 x 60 mm		10,80 kg	12,35 kg			
LTUBE98029	TUB-LINE V R1 1400/1000			1450 x 1010 x 60 mm		11,60 kg	13,30 kg			
LTUBE98030	TUB-LINE V R1 1500/1000			1550 x 1010 x 60 mm		12,45 kg	14,25 kg			
LTUBE98031	TUB-LINE V R1 1600/1000			1650 x 1010 x 60 mm		13,30 kg	15,20 kg			
COLLECTIVE PACKAGING ON REQUEST										

LUX ELEMENTS®-TUB-LINE BOL V

see page 111

INDIVIDUAL PACKAGING							
ARTICLE-NUMBER	ARTICLE-NAME	CONTAINER	PACKAGING	DIMENSIONS LENGTH x WIDTH x HEIGHT	UNIT	WEIGHT/ UNIT	WEIGHT/ CARTON
LTUBE98003	TUB-LINE BOL V R1 1800/800	1 piece	carton	1850 x 810 x 60 mm	piece	11,95 kg	13,70 kg
LTUBE98004	TUB-LINE BOL V R1 1800/900			1850 x 910 x 60 mm		13,45 kg	15,40 kg
LTUBE98001	TUB-LINE BOL V R1 1800/1000			1850 x 1010 x 60 mm		14,95 kg	17,10 kg
LTUBE98002	TUB-LINE BOL V R1 1800/1200			1850 x 1210 x 60 mm		17,95 kg	20,50 kg
COLLECTIVE PACKAGING ON REQUEST							

**LUX ELEMENTS®-TUB-LINE FINISH**

see page 113

INDIVIDUAL PACKAGING							
ARTICLE-NUMBER	ARTICLE-NAME	CONTAINER	PACKAGING	DIMENSIONS LENGTH x WIDTH x HEIGHT	UNIT	WEIGHT/ UNIT	WEIGHT/ CARTON
LTUBE94001.FW	TUB-LINE FW Q4 900	1 piece	carton	945 x 920 x 100 mm	piece	16,00 kg	18,00 kg
LTUBE94003.FW	TUB-LINE FW R4 1200/900			1250 x 920 x 100 mm		22,80 kg	24,80 kg
LTUBE94007.FW	TUB-LINE FW R4 1600/900			1650 x 920 x 100 mm		29,30 kg	31,30 kg
<b>COLLECTIVE PACKAGING ON REQUEST</b>							

**LUX ELEMENTS®-TUB-U**

see page 114/115

INDIVIDUAL PACKAGING										
ARTICLE-NUMBER	ARTICLE-NAME	CONTAINER	PACKAGING	DIMENSIONS LENGTH x WIDTH x HEIGHT	UNIT	WEIGHT/ UNIT	WEIGHT/ CARTON			
LTUBE11110	TUB-UQ 800	1 piece	carton	845 x 820 x 60 mm	piece	1,00 kg	2,00 kg			
LTUBE11111	TUB-UQ 900			945 x 920 x 60 mm		1,10 kg	2,08 kg			
LTUBE11112	TUB-UQ 1000			1045 x 1020 x 60 mm		1,36 kg	3,25 kg			
LTUBE11115	TUB-UQ 1100			1145 x 1120 x 60 mm		1,63 kg	2,84 kg			
LTUBE11113	TUB-UQ 1200			1235 x 1215 x 60 mm		1,96 kg	3,70 kg			
LTUBE11114	TUB-UQ 1500			1535 x 1515 x 60 mm		3,06 kg	6,71 kg			
LTUBE11828	TUB-UR 900/800			950 x 810 x 60 mm		0,97 kg	1,69 kg			
LTUBE11811	TUB-UR 1000/800			1050 x 810 x 60 mm		1,09 kg	2,39 kg			
LTUBE11819	TUB-UR 1100/800			1150 x 810 x 60 mm		1,19 kg	2,07 kg			
LTUBE11820	TUB-UR 1200/800			1250 x 810 x 60 mm		1,30 kg	2,26 kg			
LTUBE11821	TUB-UR 1000/900			1050 x 810 x 60 mm		1,22 kg	2,12 kg			
LTUBE11822	TUB-UR 1100/900			1150 x 910 x 60 mm		1,34 kg	2,33 kg			
LTUBE11812	TUB-UR 1200/900			1250 x 910 x 60 mm		1,47 kg	2,99 kg			
LTUBE11814	TUB-UR 1300/900			1350 x 910 x 60 mm		1,58 kg	2,75 kg			
LTUBE11815	TUB-UR 1400/900			1450 x 910 x 60 mm		1,71 kg	3,86 kg			
LTUBE11816	TUB-UR 1500/900			1550 x 910 x 60 mm		1,84 kg	4,97 kg			
LTUBE11817	TUB-UR 1600/900			1650 x 910 x 60 mm		1,96 kg	4,49 kg			
LTUBE11823	TUB-UR 1100/1000			1150 x 1010 x 60 mm		1,49 kg	2,59 kg			
LTUBE11813	TUB-UR 1200/1000			1250 x 1010 x 60 mm		1,63 kg	3,79 kg			
LTUBE11824	TUB-UR 1300/1000			1350 x 1010 x 60 mm		1,76 kg	3,06 kg			
LTUBE11825	TUB-UR 1400/1000			1450 x 1010 x 60 mm		1,89 kg	3,29 kg			
LTUBE11826	TUB-UR 1500/1000			1550 x 1010 x 60 mm		2,03 kg	3,53 kg			
LTUBE11827	TUB-UR 1600/1000			1650 x 1010 x 60 mm		2,16 kg	3,76 kg			
LTUBE18028	TUB-UBOL 1800/800			1850 x 810 x 60 mm		1,94 kg	3,38 kg			
LTUBE18019	TUB-UBOL 1800/900			1850 x 910 x 60 mm		2,20 kg	5,15 kg			
LTUBE98101	TUB-UBOL 1800/1000			1850 x 1010 x 60 mm		2,50 kg	5,50 kg			
LTUBE98102	TUB-UBOL 1800/1200			1850 x 1210 x 60 mm		3,00 kg	6,00 kg			
<b>COLLECTIVE PACKAGING ON REQUEST</b>										

LUX ELEMENTS®-TUB-HEQ/-HMQ

see page 121

INDIVIDUAL PACKAGING										
ARTICLE-NUMBER	ARTICLE-NAME	CONTAINER	PACKAGING	DIMENSIONS LENGTH x WIDTH x HEIGHT	UNIT	WEIGHT/ UNIT	WEIGHT/ CARTON			
LTUBE17004	TUB-HEQ 800	1 piece	carton	845 x 820 x 60 mm	piece	4,70 kg	5,45 kg			
LTUBE17001	TUB-HEQ 900			945 x 915 x 60 mm		6,15 kg	7,15 kg			
LTUBE17003	TUB-HEQ 1000			1045 x 1020 x 60 mm		7,30 kg	8,50 kg			
LTUBE17005	TUB-HEQ 1100			1145 x 1120 x 60 mm		8,85 kg	10,30 kg			
LTUBE17002	TUB-HEQ 1200			1235 x 1215 x 60 mm		10,45 kg	12,05 kg			
LTUBE17104	TUB-HMQ 800			845 x 820 x 60 mm		4,70 kg	5,45 kg			
LTUBE17101	TUB-HMQ 900			945 x 920 x 60 mm		6,15 kg	7,15 kg			
LTUBE17103	TUB-HMQ 1000			1045 x 1020 x 60 mm		9,50 kg	10,65 kg			
LTUBE17105	TUB-HMQ 1100			1145 x 1120 x 60 mm		8,85 kg	10,30 kg			
LTUBE17102	TUB-HMQ 1200			1235 x 1215 x 60 mm		10,45 kg	12,05 kg			
<b>COLLECTIVE PACKAGING ON REQUEST</b>										

LUX ELEMENTS®-TUB-HER/-HMR

see page 122/123

INDIVIDUAL PACKAGING							
ARTICLE-NUMBER	ARTICLE-NAME	CONTAINER	PACKAGING	DIMENSIONS LENGTH x WIDTH x HEIGHT	UNIT	WEIGHT/ UNIT	WEIGHT/ CARTON
LTUBE17014	TUB-HER 900/800	1 piece	carton	950 x 810 x 60 mm	piece	5,25 kg	6,10 kg
LTUBE17015	TUB-HER 1000/800			1050 x 810 x 60 mm		5,85 kg	6,80 kg
LTUBE17016	TUB-HER 1100/800			1150 x 810 x 60 mm		6,40 kg	7,50 kg
LTUBE17017	TUB-HER 1200/800			1250 x 810 x 60 mm		7,00 kg	8,15 kg
LTUBE17019	TUB-HER 1000/900			1050 x 910 x 60 mm		6,60 kg	7,65 kg
LTUBE17020	TUB-HER 1100/900			1150 x 910 x 60 mm		7,25 kg	8,40 kg
LTUBE17011	TUB-HER 1200/900			1250 x 910 x 60 mm		7,90 kg	9,20 kg
LTUBE17021	TUB-HER 1300/900			1350 x 910 x 60 mm		8,55 kg	9,95 kg
LTUBE17013	TUB-HER 1400/900			1450 x 910 x 60 mm		9,20 kg	10,70 kg
LTUBE17023	TUB-HER 1500/900			1550 x 910 x 60 mm		9,85 kg	11,50 kg
LTUBE17012	TUB-HER 1600/900			1650 x 910 x 60 mm		10,50 kg	12,25 kg
LTUBE17024	TUB-HER 1100/1000			1150 x 1010 x 60 mm		8,05 kg	9,35 kg
LTUBE17025	TUB-HER 1200/1000			1250 x 1010 x 60 mm		8,75 kg	10,20 kg
LTUBE17026	TUB-HER 1300/1000			1350 x 1010 x 60 mm		9,50 kg	11,05 kg
LTUBE17027	TUB-HER 1400/1000			1450 x 1010 x 60 mm		10,20 kg	11,90 kg
LTUBE17028	TUB-HER 1500/1000			1550 x 1010 x 60 mm		10,95 kg	12,75 kg
LTUBE17029	TUB-HER 1600/1000			1650 x 1010 x 60 mm		11,70 kg	13,60 kg
LTUBE17114	TUB-HMR 900/800			950 x 810 x 60 mm		5,25 kg	6,10 kg
LTUBE17115	TUB-HMR 1000/800			1050 x 810 x 60 mm		5,85 kg	6,80 kg
LTUBE17116	TUB-HMR 1100/800			1150 x 810 x 60 mm		6,40 kg	7,50 kg
LTUBE17117	TUB-HMR 1200/800			1250 x 810 x 60 mm		7,00 kg	8,15 kg
LTUBE17119	TUB-HMR 1000/900			1050 x 910 x 60 mm		6,60 kg	7,65 kg
LTUBE17120	TUB-HMR 1100/900			1150 x 910 x 60 mm		7,25 kg	8,40 kg
LTUBE17111	TUB-HMR 1200/900			1250 x 910 x 60 mm		7,90 kg	9,20 kg
LTUBE17121	TUB-HMR 1300/900			1350 x 910 x 60 mm		8,55 kg	9,95 kg
LTUBE17113	TUB-HMR 1400/900			1450 x 910 x 60 mm		9,20 kg	10,70 kg
LTUBE17123	TUB-HMR 1500/900			1550 x 910 x 60 mm		9,85 kg	11,50 kg
LTUBE17112	TUB-HMR 1600/900			1650 x 910 x 60 mm		10,50 kg	12,25 kg
LTUBE17124	TUB-HMR 1100/1000			1150 x 1010 x 60 mm		8,05 kg	9,35 kg
LTUBE17125	TUB-HMR 1200/1000			1250 x 1010 x 60 mm		8,75 kg	10,20 kg
LTUBE17126	TUB-HMR 1300/1000			1350 x 1010 x 60 mm		9,50 kg	11,05 kg
LTUBE17127	TUB-HMR 1400/1000			1450 x 1010 x 60 mm		10,20 kg	11,90 kg
LTUBE17128	TUB-HMR 1500/1000			1550 x 1010 x 60 mm		10,95 kg	12,75 kg
LTUBE17129	TUB-HMR 1600/1000	1650 x 1010 x 60 mm	11,70 kg	13,60 kg			
<b>COLLECTIVE PACKAGING ON REQUEST</b>							

**LUX ELEMENTS®-TUB-H BOL**

see page 125

INDIVIDUAL PACKAGING							
ARTICLE-NUMBER	ARTICLE-NAME	CONTAINER	PACKAGING	DIMENSIONS LENGTH x WIDTH x HEIGHT	UNIT	WEIGHT/ UNIT	WEIGHT/ CARTON
LTUBE17031	TUB-H BOL 1800/800	1 piece	carton	1850 x 810 x 60 mm	piece	10,50 kg	12,25 kg
LTUBE17018	TUB-H BOL 1800/900			1850 x 910 x 60 mm		11,85 kg	13,75 kg
LTUBE17032	TUB-H BOL 1800/1000			1850 x 1010 x 60 mm		13,15 kg	15,30 kg
COLLECTIVE PACKAGING ON REQUEST							

**LUX ELEMENTS®-TUB-LINE H**

see page 127

INDIVIDUAL PACKAGING							
ARTICLE-NUMBER	ARTICLE-NAME	CONTAINER	PACKAGING	DIMENSIONS LENGTH x WIDTH x HEIGHT	UNIT	WEIGHT/ UNIT	WEIGHT/ CARTON
LTUBE96006	TUB-LINE HQ4 800	1 piece	carton	850 x 810 x 60 mm	piece	5,40 kg	6,15 kg
LTUBE96001	TUB-LINE HQ4 900			950 x 910 x 60 mm		6,80 kg	7,80 kg
LTUBE96003	TUB-LINE HQ4 1000			1050 x 1010 x 60 mm		8,40 kg	9,60 kg
LTUBE96007	TUB-LINE HQ4 1100			1150 x 1110 x 60 mm		10,20 kg	11,60 kg
LTUBE96004	TUB-LINE HQ4 1200			1250 x 1210 x 60 mm		12,10 kg	13,80 kg
LTUBE96008	TUB-LINE HR4 900/800			950 x 810 x 60 mm		6,05 kg	6,95 kg
LTUBE96009	TUB-LINE HR4 1000/800			1050 x 810 x 60 mm		6,75 kg	7,70 kg
LTUBE96010	TUB-LINE HR4 1100/800			1150 x 810 x 60 mm		7,40 kg	8,45 kg
LTUBE96011	TUB-LINE HR4 1200/800			1250 x 810 x 60 mm		8,10 kg	9,20 kg
LTUBE96012	TUB-LINE HR4 1000/900			1050 x 910 x 60 mm		7,60 kg	8,65 kg
LTUBE96013	TUB-LINE HR4 1100/900			1150 x 910 x 60 mm		8,30 kg	9,50 kg
LTUBE96002	TUB-LINE HR4 1200/900			1250 x 910 x 60 mm		9,05 kg	10,35 kg
LTUBE96014	TUB-LINE HR4 1300/900			1350 x 910 x 60 mm		9,80 kg	11,25 kg
LTUBE96005	TUB-LINE HR4 1400/900			1450 x 910 x 60 mm		10,60 kg	12,10 kg
LTUBE96015	TUB-LINE HR4 1500/900			1550 x 910 x 60 mm		11,35 kg	12,95 kg
LTUBE96016	TUB-LINE HR4 1600/900			1650 x 910 x 60 mm		12,10 kg	13,80 kg
LTUBE96017	TUB-LINE HR4 1100/1000			1150 x 1010 x 60 mm		9,25 kg	10,60 kg
LTUBE96018	TUB-LINE HR4 1200/1000			1250 x 1010 x 60 mm		10,10 kg	11,50 kg
LTUBE96019	TUB-LINE HR4 1300/1000			1350 x 1010 x 60 mm		10,90 kg	12,45 kg
LTUBE96020	TUB-LINE HR4 1400/1000			1450 x 1010 x 60 mm		11,75 kg	13,45 kg
LTUBE96021	TUB-LINE HR4 1500/1000			1550 x 1010 x 60 mm		12,60 kg	14,40 kg
LTUBE96022	TUB-LINE HR4 1600/1000			1650 x 1010 x 60 mm		13,45 kg	15,35 kg
COLLECTIVE PACKAGING ON REQUEST							

**LUX ELEMENTS®-TUB-LINE H BOL**

see page 129

INDIVIDUAL PACKAGING							
ARTICLE-NUMBER	ARTICLE-NAME	CONTAINER	PACKAGING	DIMENSIONS LENGTH x WIDTH x HEIGHT	UNIT	WEIGHT/ UNIT	WEIGHT/ CARTON
LTUBE97102	TUB-LINE H BOL 1800/800	1 piece	carton	1850 x 810 x 60 mm	piece	12,10 kg	13,80 kg
LTUBE97101	TUB-LINE H BOL 1800/900			1850 x 910 x 60 mm		13,60 kg	15,55 kg
LTUBE97103	TUB-LINE H BOL 1800/1000			1850 x 1010 x 60 mm		15,15 kg	17,30 kg
COLLECTIVE PACKAGING ON REQUEST							

**LUX ELEMENTS®-TUB combinable floor drain systems**

see page 130/131

INDIVIDUAL PACKAGING							
ARTICLE-NUMBER	ARTICLE-NAME	CONTAINER	PACKAGING	DIMENSIONS LENGTH x WIDTH x HEIGHT	UNIT	WEIGHT/ UNIT	
LTUBE1102	TUB-BA-S	1 set	bag	305 x 205 x 160 mm	set	0,55 kg	
LTUBE1103	TUB-BA-S 100			305 x 205 x 160 mm		0,30 kg	
LTUBE1101	TUB-BA-W			305 x 205 x 160 mm		0,35 kg	
LTUBE1100	TUB-RA-S			305 x 205 x 160 mm		0,25 kg	
LTUBE1104	TUB-RA-DA			305 x 205 x 160 mm		0,60 kg	
LTUBE1105	TUB-RA-DC			305 x 205 x 160 mm		0,60 kg	
LTUBE1106	TUB-RA-DM			305 x 205 x 160 mm		0,45 kg	
LTUBE1107	TUB-RA-DL			305 x 205 x 160 mm		0,55 kg	
LTUBE1108	TUB-RA-DV			305 x 205 x 160 mm		0,35 kg	
LTUBE1110	TUB-RA-DS			305 x 205 x 160 mm		0,50 kg	
LTUBE1109	TUB-RA-DF			305 x 205 x 160 mm		0,25 kg	
LTUBE1001	TUB-RA-A			305 x 205 x 160 mm		0,35 kg	

**LUX ELEMENTS®-TUB complete floor drain systems**

see page 132

INDIVIDUAL PACKAGING							
ARTICLE-NUMBER	ARTICLE-NAME	CONTAINER	PACKAGING	DIMENSIONS LENGTH x WIDTH x HEIGHT	UNIT	WEIGHT/ UNIT	
LTUBE1180	TUB-BAS-S	1 set	bag	485 x 275 x 160 mm	set	0,85 kg	
LTUBE1193	TUB-BAS-S 100			485 x 275 x 160 mm		0,55 kg	
LTUBE1184	TUB-BAW-S			485 x 275 x 160 mm		0,65 kg	

**LUX ELEMENTS®-TUB floor drain systems accessories**

see page 133

INDIVIDUAL PACKAGING							
ARTICLE-NUMBER	ARTICLE-NAME	CONTAINER	PACKAGING	DIMENSIONS LENGTH x WIDTH x HEIGHT	UNIT	WEIGHT/ UNIT	WEIGHT/ PACKAGING
LTUBE1188	TUB-BAZ STOP	1 piece	bag	245 x 190 x 75 mm	piece	0,05 kg	0,05 kg
LTUBE1189	TUB-BAZ HS			245 x 190 x 75 mm		0,02 kg	0,02 kg
LTUBE1200	TUB-BAZ DN 50/40			245 x 190 x 75 mm		0,05 kg	0,05 kg
LTUBE1190	TUB-BAZ BST			245 x 190 x 75 mm		0,06 kg	0,06 kg
LTUBE1192	TUB-BAZ HTK			245 x 190 x 75 mm		0,05 kg	0,05 kg
LTUBE1197	TUB-BAS-S FIRE STOP	1 set	carton	485 x 275 x 160 mm	set	1,20 kg	1,20 kg
LTUBE1198	TUB-BAZ DGD			305 x 205 x 160 mm		0,40 kg	0,40 kg
LTUBE1191.6	TUB-TSM 6	1 piece	—	—	piece	3,20 kg	3,20 kg
LTUBE1191.12	TUB-TSM 12		—	—		4,70 kg	4,70 kg



**LUX ELEMENTS®-TUB-LINE floor drain systems/accessories**

see page 135

INDIVIDUAL PACKAGING							
ARTICLE-NUMBER	ARTICLE-NAME	CONTAINER	PACKAGING	DIMENSIONS LENGTH x WIDTH x HEIGHT	UNIT	WEIGHT/ UNIT	
LTUBE1113	TUB-LINE BA-S	1 piece	bag	305 x 205 x 160 mm	piece	0,40 kg	
LTUBE1112.22	TUB-LINE BA-W 22			305 x 205 x 160 mm		0,25 kg	
LTUBE1112.50	TUB-LINE BA-W 50			305 x 205 x 160 mm		0,25 kg	
LTUBE1115.50	TUB-LINE BA-GV 50			245 x 190 x 75 mm		0,05 kg	
LTUBE1288	TUB-LINE BAZ STOP			245 x 190 x 75 mm		0,05 kg	
LTUBE1114	TUB-LINE BAZ HS			20 x 255 x 160 mm		0,02 kg	
LTUBE1200	TUB-BAZ DN 50/40			245 x 190 x 75 mm		0,05 kg	
LTUBE1190	TUB-BAZ BST			245 x 190 x 75 mm		0,06 kg	
LTUBE1192	TUB-BAZ HTK			245 x 190 x 75 mm		0,05 kg	
LTUBE1289	TUB-LINE BA-S FIRE STOP			1 set			305 x 205 x 160 mm
LTUBE1198	TUB-BAZ DGD	1 piece	carton	305 x 205 x 160 mm	piece	0,40 kg	
LTUBE1191.6	TUB-TSM 6		–	–		3,20 kg	
LTUBE1191.12	TUB-TSM 12		–	–		4,70 kg	

**LUX ELEMENTS®-TUB-KIT**

see page 137

INDIVIDUAL PACKAGING							
ARTICLE-NUMBER	ARTICLE-NAME	CONTAINER	PACKAGING	DIMENSIONS LENGTH x WIDTH x HEIGHT	UNIT	WEIGHT/ UNIT	WEIGHT/ PACKAGING
LTUBE1090	TUB-KIT UNI	1 kit	pail	height 240 mm; Ø 280 mm	kit	10,00 kg	10,00 kg
LTUBE1098	TUB-KIT UNI GK			400 x 310 x 350 mm		19,60 kg	19,60 kg
LTUBE1099	TUB-KIT UNI GG			400 x 310 x 350 mm		29,62 kg	29,62 kg

## Data protection information for business partners

Revised August 2018

### Our handling of your data and your rights

Information according to articles 13, 14 and 21 of the General Data Protection Regulation (GDPR)

In accordance with the EU General Data Protection Regulation (GDPR) valid from 25 May 2018, we wish to take the opportunity with this data protection information to inform you, our business partners, about how we process your personal data and about your rights. This information will be updated whenever necessary and published on [www.luxelements.com](http://www.luxelements.com), where you will also find our data protection information for visitors to our website.

### 1. Who is responsible for the data processing and who is the Data Protection Officer?

Responsible is: LUX ELEMENTS GmbH & Co. KG  
An der Schusterinsel 7  
D - 51379 Leverkusen  
Tel.: +49 (0) 21 71 / 72 12-0  
Fax: +49 (0) 21 71 / 72 12-40  
E-Mail: [info@luxelements.de](mailto:info@luxelements.de)

Our Data Protection Officer Julia Lux can be contacted at the above address or by e-mail to [datenschutz@luxelements.de](mailto:datenschutz@luxelements.de). The contact data are also available online at:

<https://www.luxelements.com/lux/impressum.htm#datenschutz>

### 2. What sources and data are used?

LUX ELEMENTS GmbH & Co. KG processes data that it obtains from the business relationship with you, for example in the context of the handling of customer contracts, personnel and supplier administration, and attendance to commercial agents and prospective customers.

Specifically, the following data in particular are processed:

- identifying data (e.g. name, address and contact data of the business partner, bank account details)
- information on the risk profile of the business partner, including creditworthiness and financial solvency as well as information in accordance with the suitability declaration
- data connected with the execution of the specific order
- tax-relevant data
- contract data for other correspondence (e.g. correspondence with you)
- advertising and sales data (e.g. products and services that are potentially of interest to you)

### 3. What is the purpose of the processing of my data and what is the legal basis for this?

LUX ELEMENTS GmbH & Co. KG processes your data on the following legal basis and for the purposes listed below:

#### 3.1 For the fulfilment of contractual obligations (Article 6, section 1 b) GDPR)

Your data are processed in order to execute our contracts with you, i.e. for example for the carrying out of the service ordered. The purposes of the data processing depend in detail on the specific service and the contract documents.

#### 3.2 In the context of the weighing of interests (Article 6, section 1 f) GDPR)

In addition, your data may be used on the basis of a weighing of interests to protect our justified interests or those of third parties. This takes place for the following purposes:

- general business management and the further development of services, systems and products
- fulfilment of internal requirements and the requirements of our affiliated companies, insurance, checking or administration purposes

- guaranteeing IT security and IT operation
- advertising, market and opinion research
- assertion of legal claims and defence in legal disputes
- prevention and solving of crimes as well as risk management and prevention of fraud

The interest of LUX ELEMENTS GmbH & Co. KG in the respective processing arises from the respective purposes and is otherwise of a business nature (efficient fulfilment of tasks, sales, avoidance of legal risks).

If the specific purpose allows, LUX ELEMENTS GmbH & Co. KG processes your data in pseudonymised or anonymised form.

#### 3.3. On the basis of your consent (Article 6, section 1 a) GDPR)

If you have given your consent to the processing of personal data, the respective consent is the legal basis for the processing mentioned there.

In addition, you may have consented to being contacted by e-mail or telephone for advertising purposes.

You can revoke your consent at any time with effect for the future.

This also applies to declarations of consent that you have made to LUX ELEMENTS GmbH & Co. KG before the coming into force of the GDPR, i.e. before 25 May 2018. The revocation applies only to future processing.

#### 3.4. On account of legal regulations (Article 6, section 1 c) GDPR)

LUX ELEMENTS GmbH & Co. KG is subject to various legal obligations, i.e. legal requirements (e.g. technical checking regulations, industrial health and safety regulations, money laundering laws, tax laws).

The purposes of processing include the checking of identity and age, the prevention of fraud and money laundering, accounting, the evaluation and control of risks (including the creation of a risk profile for business partners, as well as the checking of creditworthiness and the fulfilment of checking and reporting obligations under tax laws).

### 4. Who receives my data?

LUX ELEMENTS GmbH & Co. KG passes on your data only in compliance with the GDPR and the BDSG (German Federal Data Protection Act). Within LUX ELEMENTS GmbH & Co. KG, your data is received by those bodies that require it in order to fulfil the contractual and legal obligations or to fulfil their respective tasks (e.g. Sales, Marketing and Accounts).

In addition, the following bodies may receive your data:

- processors (Art. 28 GDPR) employed by us, in particular in the fields of IT services, logistics, disposal and printing services, who process your data for us according to our instructions
- public bodies and institutions where there is a legal or official obligation
- our respective employees, advisers, representatives, proxies, accountants, service providers
- other bodies for whom you have given us your consent to be given your data

### 5. How long will my data be stored?

We delete your personal data as soon as it is no longer required for the aforementioned purposes. After the termination of the business relationship your personal data will be stored if we are legally obligated to do so. This arises from legal verification and archiving obligations, which are governed among others by the German Commercial Code and Fiscal Code. Accordingly, storage periods may be up to ten years. In addition, it may be the case that personal data is stored for the period during which claims may be asserted against us (legal statute of limitations of three or up to thirty years).

### 6. Are data transmitted to a third-party country or an international organisation?

Your data are transmitted to states outside of the European Economic Area – EEA (third countries) only if this is necessary for the execution of your orders or is legally prescribed or if you have given your consent thereto.

### 7. What other data protection rights do I have?

Under the respective legal conditions, you have the right to information (Article 15 GDPR), to correction (Article 16 GDPR), to deletion (Article 17 GDPR), to restriction of the processing (Article 18 GDPR) and to data transferability (Article 20 GDPR).

In addition, you have the right to complain to a data protection supervisory authority (Article 77 GDPR).

You can assert these rights centrally against LUX ELEMENTS GmbH & Co. KG.

The responsible supervisory authority is the State Officer for Data Protection and Freedom of Information for North Rhine-Westphalia:

Landesbeauftragte für Datenschutz und Informationsfreiheit

Nordrhein-Westfalen

Postfach 20 04 44

D - 40102 Düsseldorf

Tel.: +49 (0) 211 / 3 84 24-0

Fax: +49 (0) 211 / 3 84 24-10

E-Mail: [poststelle@ldi.nrw.de](mailto:poststelle@ldi.nrw.de)

### Right of objection

**You have the right to object to the processing of your personal data for the purposes of direct advertising without giving reasons. If we process your data for the protection of justified interests, you can object to this processing for reasons arising from your particular situation. We will then no longer process your personal data unless we can prove that there are compelling reasons worthy of protection for the processing that outweigh your interests, rights and freedoms or that the processing serves the assertion or exercising of, or defence against legal claims.**

### 8. What data protection rights can I assert as the person affected?

Within the framework of our business relationship you need only provide such personal data as are necessary for the establishment, conduction and termination of a business relationship or to whose acquisition we are legally obligated.

## General terms and conditions LUX ELEMENTS GmbH & Co. KG

Released December 2017

### I) General

1. LUX ELEMENTS GmbH & Co. KG (the Seller) accepts and executes all orders exclusively based on the following terms and conditions.
2. The Buyer accepts these terms and conditions by placing his order. Conflicting purchase terms of the Buyer shall only be binding if accepted by the Seller in writing.
3. Ancillary verbal agreements including discounts, bonuses and dispositions shall only be valid if confirmed in writing by the Seller.

### II) Terms of delivery

1. Deliveries are made at the Seller's discretion from the Leverkusen plant or from the Seller's warehouse. Deliveries are at the Buyer's risk if the Buyer is a Merchant and in any case to the account of the Buyer.
2. If the Buyer does not accept the goods at the agreed time, the Seller shall be entitled to withdraw from the delivery contract after setting a one-week acceptance period. The provisions of the German Civil Code (BGB) regarding default of acceptance shall remain unaffected.
3. If, at the request of the Buyer, the Seller takes back any goods as a gesture of goodwill, the Buyer shall bear the return freight. For the processing and handling of the goods, 15 percent of the goods' net value shall be deducted from the credit note to be issued by the Seller. Only goods from the currently valid product range can be returned, with the exception of construction chemical products and custom-made products.

### III) Delayed delivery

1. All sales are subject to the timely supply to us by our suppliers. This does not apply if the Seller is responsible for the delay.
2. In case of force majeure, in particular labour disputes, official intervention and operational breakdowns for which the seller is not responsible, the delivery period shall be extended by the duration of the disruption provided that it does not take an unreasonably long time. In case of delays beyond this time, the parties shall mutually agree whether to adhere to or cancel the contract. The buyer shall not be entitled to claim damages in this regard.
3. In the event of delay of the Seller, the Buyer shall grant a period of grace of 10 days unless a firm deal has been agreed upon. This grace period can be set in writing earliest after the expiry of the delivery period.

In the event of delayed delivery, claims for damages due to default shall be excluded in cases of ordinary negligence, if the Buyer is a Merchant, and it is not a firm deal. In any event, in the case of slight negligence, the liability for damages shall be limited to the foreseeable losses.

### IV) Warranty

1. The warranty period shall be one year if the Buyer is a Merchant. The Seller will meet its warranty obligation by means of replacement.
2. The Seller shall not be liable for any consequential loss or damages. This shall not apply for consequential damages arising from injury to life, body or health; or which can be attributed to gross negligence, intent or breach of a substantial contract obligation (cardinal obligation); or in case of damages resulting from a failure to achieve warranted characteristics, quality or durability guarantees. If the Seller is liable for consequential damages and the Buyer is a Merchant, the liability of the Seller shall be limited to the foreseeable losses if the damage arises from the negligent breach of a substantial contract obligation (cardinal obligation).
3. If goods such as joint sealing materials are sold as per sample, the guarantee is limited to the professional compliance with the sample.
4. The information provided in the Seller's datasheets is based on the state of knowledge at the time when the datasheets were issued. They are solely intended to describe the products with view to safety requirements. They do not constitute any assurance of delivery specifications.
5. The instructions for use issued by the Seller should be considered a general guide only. Given the diversity of uses of each product and

taking into account the specific application situation, the Buyer shall be responsible to conduct its own trials.

6. Buyers intending to resell the goods received from the Seller take the sole responsibility for the correct packing, classification and marking of hazardous substances, see art. 15 GefStoffV (German Ordinance on Hazardous Substances). In particular the Buyer shall not be entitled to any claims if the packing, classification or marking provided by the Seller does no longer comply with the current regulations as a result of legal changes made after the delivery of the goods. The Seller explicitly does not assume any obligation to provide information on such legal changes.

7. The same (6) shall apply if goods of the Seller are packed using packing material of the Buyer. In this case the Buyer takes the entire responsibility for the packing and marking. As regards insufficient packing and/or marking, the Buyer shall indemnify the Seller from all third party claims.

### V) Terms of payment

1. The invoice is issued on the day of despatch or availability of the goods after receipt of the delivery note. Unless otherwise agreed, the price shall be calculated based on the prices in effect on the day of delivery.
2. Invoices shall be payable within 14 days of the invoice date after deducting a discount of 2 percent or within 30 days net.
3. The offsetting against counter-claims shall not be permitted unless the Buyer's claims are undisputed or have been determined as legally binding.
4. A significant deterioration of the Buyer's financial situation shall entitle the Seller, with no prejudice to any other rights, to execute the remaining orders on a delivery against payment basis. Under the same preconditions, the Seller's claims for payment from previous deliveries shall become due for immediate payment.
5. Merchants shall be entitled to the right of retention arising from alleged deficiencies of the goods only if the deficiencies of the goods are undisputed or have been determined as legally binding. In all other instances, the Buyer may demonstrate the deficiency of the goods supplied through a professional opinion which is not arbitration opinion and which has been provided by a publicly appointed and sworn expert whereupon the Seller remains free to raise objections to this opinion.

### VI) Retention of title

1. The Seller shall retain title to the delivery items until complete payment of the purchase price. If the Buyer is a Merchant, the Seller shall in addition retain title to the delivery item until all its claims against the Buyer arising out of the entire business relationship have been settled.
2. In the event the goods supplied are processed or combined with other material, the Seller shall become co-owner of the new manufactured items in the ratio the value of goods subject to retention of title bears to the value of the new items so resulting from the production process. The time of such processing decides upon the value of the goods subject to retention of title as well as the value of processing. During the processing, the Buyer shall act on behalf of the Seller without, however, acquiring any entitlement against the Seller as a result of the processing. The Buyer is obliged to store the goods subject to retention of title carefully on behalf of the Seller. If the Seller does not obtain co-ownership of the combination of several items, the Buyer shall already transfer a co-ownership share in accordance with the provisions of section 6 no. 2 sentences 1 and 2. The required declarations of intent are already being executed.
3. Where the new product is resold by the Buyer, the Buyer's claim to the purchase price shall, by way of security, take the place of the product in accordance with the provisions of section 6 no. 2 sentences 1 and 2. The Buyer shall assign the claims to the purchase price on a pro-rata basis to the Seller who hereby accepts the assignment.
4. If the Buyer re-sells the unprocessed goods, the Buyer shall hereby

assign all claims, including any ancillary rights, to the Seller up to the amount of his claims. The Seller hereby accepts the assignment.

5. The amounts collected are to be transferred to a separate account for the benefit of the Seller.
6. If the value of the securities exceeds the Seller's claims by more than 10 percent, the Seller shall, at the request of the Buyer, release the exceeding amount of the securities to the Buyer.
7. The Buyer shall inform the Seller immediately in writing if an attachment is enforced upon the goods subject to retention of title or upon goods in the co-ownership of the Seller or upon claims transferred to the Seller by way of an advance assignment. The Buyer must inform the enforcement authority and the judgment creditor without delay that the goods are subject to retention of title or co-owned by the Seller or the fact that the claim has been assigned to the Seller.

### VII) Place of performance and jurisdiction

1. Place of performance for all goods and services arising from this supply contract is the domicile of the Seller's commercial establishment.
2. For Merchants, the place of jurisdiction for all obligations of the parties (including actions on bills of exchange or cheques) is Leverkusen.

### VIII) Applicable law

The purchase contract shall be subject to German law to the exclusion of the United Nations Convention on Contracts for the International Sale of Goods of 11 April 1980.

### IX) Final provisions

The invalidity of one or more provisions of these terms and conditions shall in no way affect the validity of the remaining provisions.

**LUX ELEMENTS GmbH & Co. KG,**  
**An der Schusterinsel 7, D-51379 Leverkusen,**  
**Tel.: +49 (0)2171-7212-0, Fax: +49 (0)2171-7212-30**



**D LUX ELEMENTS GmbH & Co. KG**  
An der Schusterinsel 7 · D - 51379 Leverkusen-Opladen  
Tel. +49 (0) 21 71/72 12-0  
[info@luxelements.de](mailto:info@luxelements.de)

**F LUX ELEMENTS S.A.S**  
ZI-31, rue d'Ensisheim · F - 68190 Ungersheim  
Tél. +33 (0) 3 89 83 69 79  
[info@luxelements.fr](mailto:info@luxelements.fr)



[www.luxelements.com](http://www.luxelements.com)